

2020



**PRODUCT BROCHURE  
2020**

**SPECIALIST MATERIALS FOR BUILDING ENVELOPE  
&  
SOLUTIONS FOR ROOFTOP LIVING**

## CONTENTS

PAGE

<b>PEDESTALS &amp; SUPPORT PADS FOR PAVING</b> .....	<b>1</b>
5mm PVC PADS WITH SEPARATE CROSS SPACERS .....	2
7mm PVC PADS FOR PAVING .....	4
9mm RUBBER PAVING SUPPORT PADS .....	5
14mm & 17mm FIXED HEIGHT PLASTIC SUPPORT PADS .....	7
3mm-8mm WEDGE SHAPED PVC SHIMS / SLOPE CORRECTORS .....	9
ACCESSORIES FOR FIXED HEIGHT PADS - PLASTIC SHIMS .....	10
ACCESSORIES FOR FIXED HEIGHT PADS - RUBBER ACOUSTIC SHIMS .....	11
MINIPADS FOR PAVING – 10mm-20mm / 22mm-30mm / 28mm-40mm .....	12
ASP ADJUSTABLE PAVING PEDESTALS - up to 365mm .....	15
BALANCE ADJUSTABLE PEDESTALS FOR PAVING - up to 395mm .....	19
FLAT HEADED ADJUSTABLE SUPPORTS - up to 365mm .....	21
ASP EXTRA - EXTENDED HEIGHT RANGE PAVING PEDESTALS - up to 380mm .....	22
MINI BASES FOR ASPs .....	23
METAL EDGING PLATE FOR PAVING .....	24
HEADPIECES FOR ASPs .....	25
SLOPE CORRECTORS FOR ASPs & MEGAPADS .....	26
MEGAPADS FOR PAVING - up to 1020mm .....	27
EASYKEY .....	29
METAL CLIPS FOR EDGING & STEP DETAILS FOR PAVING .....	31
<b>TIMBER DECKING</b> .....	<b>33</b>
5mm PVC PADS FOR DECKING .....	34
7mm PVC PADS FOR DECKING .....	36
TD PLUS HEADPIECE FOR 7mm PVC PAD .....	37
TD MINIPADS FOR DECKING – 10mm-20mm / 22mm-30mm / 28mm-40mm .....	38
TD SUPPORT PADS FOR DECKING - up to 365mm .....	41
TD EXTRA - EXTENDED HEIGHT RANGE DECKING PEDESTALS - up to 380mm .....	46
90mm WIDE TD HEADPIECES FOR DECKING .....	47
TD PLUS SUPPORT PADS FOR DECKING - up to 365mm .....	48
TD MOBILE - ADJUSTABLE HEADPIECE FOR DECKING .....	49
TD MEGAPADS - up to 1020mm .....	50
FLAT HEADED TD MEGAPADS - up to 1020mm .....	53
TD PLUS MEGAPADS - up to 1020mm .....	55
SHOCK ABSORBING SHIMS .....	56
FLAT HEADED ADJUSTABLE SUPPORTS - up to 365mm .....	57
SLOPE CORRECTORS FOR TD, TD PLUS, TD MOBILE & TD MEGAPAD PEDESTALS .....	59
METAL CLIPS FOR EDGING & STEP DETAILS FOR DECKING .....	60
<b>TIMBER &amp; DECKING PRODUCTS</b> .....	<b>63</b>
TROPICAL HARDWOOD TIMBER DECKING TILES .....	64
MODULO FSC® 100% PLANTATION TEAK DECKING TILES .....	70
iDECKING - EASYCLICK .....	74
iDECKING - EASYCHANGE .....	77
TYPES OF DECKING - DURO EXCELLENCE .....	78
TYPES OF DECKING - TROPICAL HARDWOODS .....	81
OILS & MAINTENANCE PRODUCTS .....	83
<b>GREEN ROOF SYSTEMS</b> .....	<b>85</b>
M-TRAY® MODULAR GREEN ROOF SYSTEM .....	87
ROLL-OUT EXTENSIVE GREEN ROOFS .....	94
BIODIVERSE ROOF SYSTEMS .....	96
INTENSIVE GREEN ROOFS .....	97
ACCESSORIES FOR GREEN ROOFS .....	98

<b>CONTENTS</b>	<b>PAGE</b>
<b>DRAINAGE PRODUCTS</b> .....	<b>101</b>
PROTECTO-DRAIN .....	102
PROTECTO DRAIN 8 .....	103
PROTECTO DRAIN G8 .....	104
PROTECTO DRAIN 20 .....	105
PROTECTO DRAIN 20P .....	106
PROTECTO DRAIN ACCESSORIES .....	107
PROTECTO DRAIN DRAINAGE CHANNEL .....	109
TPE DOWNPIPE CONNECTORS .....	113
TPE THROUGH WALL OUTLETS / FITTINGS .....	115
TPE PIPE COLLARS .....	118
TPE VENTS & AERATORS .....	119
EDPM DOWNPIPE CONNECTORS .....	121
EDPM THROUGH WALL OUTLETS / CONNECTORS .....	124
PVC DOWNPIPE CONNECTORS .....	125
PVC THROUGH WALL OUTLETS .....	127
PVC COLLARS .....	129
PVC VENTS & AERATORS .....	130
CAPS FOR VENTS .....	131
LEAF GUARDS .....	132
GRAVEL EXCLUDERS .....	133
EXTENSION SHANKS IN TPE .....	134
JUBILEE CLIPS .....	134
PATCHES IN TPE & PVC .....	135
COUPLINGS .....	136
<b>PROTECTION MEMBRANES</b> .....	<b>139</b>
PROTECTO BOARD - BITUMINOUS .....	140
PROTECTO MAT - RUBBER CRUMB .....	143
<b>GEOTEXTILE FABRICS</b> .....	<b>147</b>
HIGH TENACITY VIRGIN FIBRE POLYPROPYLENE GEOTEXTILE .....	150
RECYCLED POLYESTER GEOTEXTILE .....	151
<b>FIXINGS &amp; ANCHORS</b> .....	<b>157</b>
D PLUS RANGE .....	158
D H RANGE .....	158
<b>IT TOOLS &amp; DESIGN RESOURCES</b> .....	<b>161</b>
BIM, RIBA PRODUCT SELECTOR, NBS PLUS .....	161
CAD IMAGES .....	161
CPD .....	161
ESB FLOORSYNC .....	162
MEGAPRO SOTFWARE .....	163
<b>PROJECTS &amp; CASE STUDIES</b> .....	<b>165</b>
WIMBLEDON, LONDON, UK - M-TRAY®, EASYCLICK IDECKING, ASPs, OUTLETS & GEOTEXTILES .....	165
FINSBURY PARK, LONDON, UK - ASP PEDESTALS .....	166
BERMONDSEY, LONDON, UK - TIMBER TILES, ASPs & MINI MEGAPADS .....	166
WARLINGHAM, SURREY, UK - EASYCLICK IDECKING .....	167
ST KATHERINE'S DOCK, LONDON, UK - TDs & ASPs .....	168
BAKU, AZERBAIJAN - ASPs .....	168
VALE OF YORKSHIRE, UK - M-TRAY® .....	169
KENNINGTON, LONDON, UK - TIMBER TILES .....	169
KINGS CROSS, LONDON, UK - ASPs & TDs .....	170
WANDSWORTH, LONDON, UK - M-TRAY® .....	170
WARLINGHAM, SURREY, UK - EASYCHANGE IDECKING .....	171
KENSINGTON, LONDON, UK - MINI MEGAPADS & ASPs .....	171
STRATFORD, LONDON, UK - TD EXTRA & TD EXTRA MOBILE .....	172
VANCOUVER, CANADA - M-TRAY® .....	172
KENNINGTON, LONDON, UK - TDs .....	173
HEATHROW, LONDON, UK - M-TRAY® .....	173



The mark of responsible forestry



[www.facebook.com/wallbarn](http://www.facebook.com/wallbarn)



[www.twitter.com/wallbarn](http://www.twitter.com/wallbarn)



## PEDESTALS & SUPPORT PADS FOR PAVING

Wallbarn offers the largest range of pedestals in the UK. Our products include simple fixed height support pads and extra high adjustable pedestals with specialised designs and variations to accommodate the different types of roof and podium deck.

The major advantages of using support pedestals are to improve drainage, ease and speed of installation and protection of the surface beneath. They also vastly reduce mess and disturbance during installation.

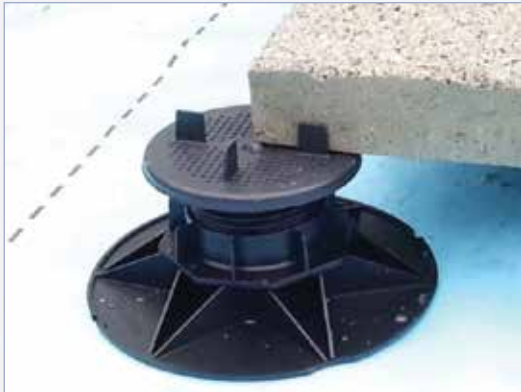

No mechanical fixings are required. The weight of the slab holds the system in place. As the paving slabs are suspended, the waterproofing membrane is not pierced or compromised in any way.

Installation is much faster, cleaner and easier than by bedding paving slabs into mortar. They also future-proof the roof deck, as they can be lifted at any time if the deck beneath requires inspection or maintenance.

## STANDARD PAVING LAYOUT

The positioning lugs separate the slabs and give a uniform paving line. One corner of the slab rests on a quadrant of the pedestal.



## STRETCHER BOND / HALF BOND / STAGGERED LAYOUT

For stretcher bond paving schemes one of the positioning lugs can be removed so that a slab will rest on half of the pedestal head, which gives proper support.

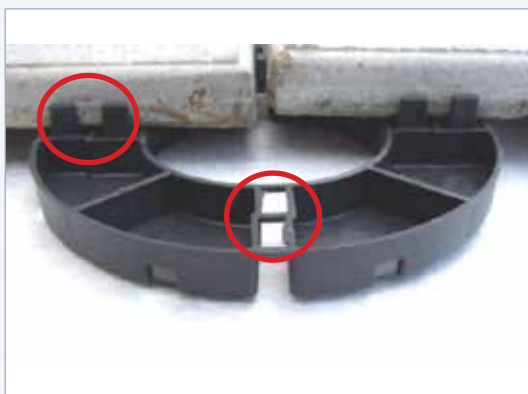

## 5MM PVC PADS WITH SEPARATE CROSS SPACERS

The range of paving pedestals and supports starts with the fixed height 5mm PVC pad. The system works by using a 5mm thick circular PVC disc and a separate loose cross spacer.

These ultra-thin paving pads give the minimal amount of lift off the deck. The membrane beneath is protected from direct contact with a heavy paving slab. If users wish to simply have protection and separation from the deck, this product is suitable.



This circular pad is manufactured from PVC and cut into a disc measuring 150mm in diameter. Both sides are smooth and flat. The cross spacer is made from polypropylene and is placed onto the upper surface. Since the cross spacers are not fixed to the rubber disc, there is not as much of the positioning guide given from other Wallbarn spacers and pedestals. These products are on offer where height thresholds are extremely limited and separation is the most important factor.

The cross spacers are available in a variety of thicknesses, so if users wish to have larger gaps between the paving slabs, flexibility is possible.

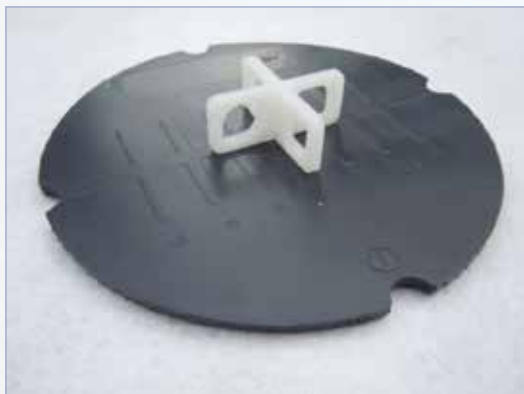

Cross spacers can also be used on the other Wallbarn paving pads and pedestals, where perhaps users wish to increase the gap between the slabs on paving areas already installed.

## TECHNICAL DATA

CODE FOR RUBBER DISC	SP-RUB-005
CODE FOR CROSS SPACERS	SP-PLA-003-CROSS SPACER
	SP-PLA-004-CROSS SPACER
	SP-PLA-005-CROSS SPACER
MATERIAL	PVC
THICKNESS / HEIGHT OFF SURFACE	5MM
WIDTH OF CROSS SPACERS (DISTANCE BETWEEN PAVING SLABS)	3MM, 4MM & 5MM WIDTH AVAILABLE
CROSS SPACER HEIGHT	20MM
WEIGHT TOLERANCE / BEARING CAPACITY	8,000KG
OUTER DIAMETER	150MM
APPEARANCE	FLAT DISC BOTH SIDES



## 7MM PVC PADS FOR PAVING

The next height of paving pedestals and supports is the fixed height 7mm PVC paving pad.

These ultra-thin paving pads still provide adequate drainage. By lifting the slab off the deck the rainwater is able to be channelled between and below it and towards the drainage outlet. This prevents ponding on the surface. The paving lugged headpiece sits into a slight indent which is moulded into the PVC pad, so the overall height remains at 7mm thick. Again, there is no mechanical fixing required, the weight of the slab holds everything secure and in place.



This circular pad is manufactured from PVC into a 150mm diameter disc. The upper surface is moulded into a series of circular ridges and grooves which encourages the rainwater to run off the surface of the pad. Water will not be held between the gaps in paving as there is a clear escape route.

These pads are ideal for areas where the height threshold is restricted. This is often the case in refurbishment projects, where an existing surface or system is overlaid.



The PVC compound means these pads have a soft, flexible, hard-wearing profile; helping to protect the membrane beneath from damage. PVC will also offer acoustic properties and create a separation layer from the deck. They are extremely tough and durable and will also not become brittle in cold weather.

The removable headpiece is manufactured in plastic and is clicked into place through a hole in the centre of the pad. A large range of different sized lug widths are available.

For fine adjustments to the level or the height, Wallbarn Levelling Shims can be used. Placed on the upper side of the discs, these plastic shims are supplied 1mm, 2mm and 3mm thick. They can be snapped into quarters or halves, where only one side of the disc needs height alteration. Please see section - Accessories for Fixed Height Pads.

## TECHNICAL DATA

CODE	SP-RUB-007-PAVING
MATERIAL	PVC
THICKNESS / HEIGHT OFF SURFACE	7MM
LUG WIDTH (DISTANCE BETWEEN PAVING SLABS)	2.2MM STANDARD WIDTH (4MM, 6MM, 8MM & 10MM ALSO AVAILABLE)
LUG HEIGHT	15MM
WEIGHT TOLERANCE / BEARING CAPACITY	8,000KG
OUTER DIAMETER	150MM
NUMBER OF DRAINAGE HOLES	6



## 9MM RUBBER PAVING SUPPORT PADS

The 9mm Rubber Paving Support Pads have a slightly different design. They are manufactured into a circular ring with a hollow centre. They are made from a compound of synthetic and natural rubber and are designed to be tough, flexible and durable, able to tolerate heavy loads without damaging the surface beneath.



Since the 9mm Rubber Paving Support Pads are made from synthetic rubber as opposed to plastic, they offer the distinct advantages of being flexible and easy to cut. They have a rounded edge to prevent denting the membrane beneath, making them ideal for installation directly onto more delicate surfaces, such as insulation or single ply. They are extremely tough and durable, with a weight tolerance of 8 tonnes.

They also offer sound and vibration insulation, and are extremely resistant to extremes of heat and cold. They will not become brittle in cold weather. The rubber compound ensures that the pads give a certain amount of grip, and will not slip on the surface beneath when being installed.



As with all the Wallbarn paving pedestals, there is no mechanical fixing required with the Rubber Paving Support Pads or any need to lay slabs in mortar – the surface is secured by the weight of the slab or covering. Contractors can take up, reposition, or change completely the slabs, or inspect the deck beneath at any time without issue.



The lugs ensure that the paving slabs are clearly separated from each other with regular spacing, giving a uniform paving line and making the installation process fast, easy and without mess.

The 5mm gap provides good drainage between and beneath the slabs, which are lifted high enough off the sub-deck to ensure no blockages occur. On the underside there are a series of grooves which channel rainwater away from the centre of the ring, so no standing water is left in the long-term.



The material itself is extremely tough but flexible, meaning that the sub-deck is somewhat cushioned from the slabs. The pads will not slip on the sub-deck and they can be laid onto very hard surfaces such as concrete or glass without scratching or damage.



### ADJUSTMENT / HEIGHT INCREASES

Often roof decks and surfaces will have dips or ridges in certain areas and increases and adjustments will need to be made to individual pads to ensure the slabs are smoothly laid. These fine adjustments can be made with Wallbarn Levelling Shims. Placed on the upper side of the support pads, these plastic shims are supplied 1mm, 2mm and 3mm thick. They can be snapped into quarters or halves, where only one side of the support pad needs height alteration. Please see section - Accessories for Fixed Height Pads.

If users require a greater height than 9mm, then a multiple number of shims can be added to create a thickness of 13mm.

### TECHNICAL DATA

MATERIAL	SYNTHETIC / NATURAL RUBBER COMPOUND
THICKNESS / HEIGHT OFF SURFACE	9MM
LUG WIDTH (DISTANCE BETWEEN PAVING SLABS)	5MM
LUG HEIGHT	9MM
WEIGHT TOLERANCE / BEARING CAPACITY	8,000KG
OUTER DIAMETER	120MM
INNER DIAMETER	55MM
THICKNESS OF DRAINAGE CHANNELS	4MM PER CHANNEL (8 CHANNELS PER PAD)

## 14MM & 17MM FIXED HEIGHT PADS

Wallbarn supplies a range of standard plastic paving rings for cost effective standard paving schemes. Our paving spacers are made from injection moulded high density polypropylene made from recycled plastic. The ring shaped pad is a simple design, but very hard wearing and tough. They are circular in shape with a hollow middle and a smooth, flat underside. They are particularly ideal for ballasting inverted waterproofing systems.



Paving slabs are suspended on the pads so that the corners of four slabs rest on the four segments. The 3mm thick positioning lugs, which are located at right angles to each other, position and separate the slabs to ensure sufficient drainage. The rainwater passes through these gaps and underneath the slabs towards the roof outlet. The whole system is held securely in place by the weight of the slab.



The suspended system ensures that there is no standing water on top of the slabs and the rainwater can be channelled and collected efficiently.

There are a series of small holes within each segment of the support pad for drainage, meaning water does not collect either in the hollow outer ring or in the central hole.

The positioning lugs ensure clear, consistent spacing between each slab, which gives uniform, straight paving lines. This speeds up the installation process significantly and creates an attractive, superior finish to paved areas.

Wallbarn plastic fixed height support pads are made from recycled HDPE, making them strong and resistant to the elements. It is vital that these pads can withstand cold temperatures in the long-term.

Beware poor quality pads which become brittle and shatter in cold temperatures – they risk the safety of pedestrians.



Wallbarn plastic paving pads are lightweight and easy to handle, but also strong and durable. They are easy to lay out and position, and the installation process is fast, efficient and clean.



Mortar or binding is not required, meaning less mess and weight on the roof. Structural movement is not a problem since the slabs are suspended. No fixings are required in the system, so nothing penetrates the waterproofing membrane. Manufacturers' warranties are therefore unaffected.



Wallbarn recommends that a maximum of 2 units are ever stacked up. Please see our adjustable pedestal section for paving schemes that exceed this maximum.

### DETAILING

The support pads are made in four quadrants joined together with a small link. They can be easily snapped into segments of a half or quarter to support paving slabs up to edges or around corners.

This eliminates wastage and gives a tidier finish to details.

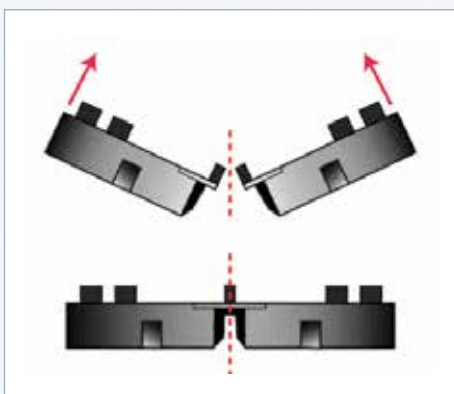

## REMOVING THE LUGS

For stretcher bond paving patterns, or if contractors are laying very large or very thin tiles which require additional support under the centre, the lug fittings can be removed to create a flat disc.

A sharp knife should be used to remove the lug fitting on one of the segments and the slab laid down onto one half (rather than one quarter) of the support pad.

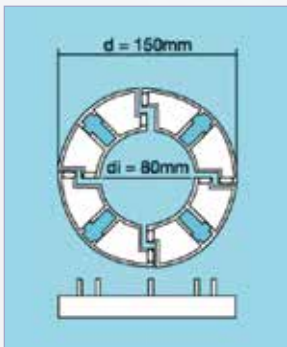

## TECHNICAL DATA

MATERIAL	INJECTION MOULDED HDPE
THICKNESS / HEIGHT OFF SURFACE	14MM & 17MM
LUG WIDTH (DISTANCE BETWEEN PAVING SLABS)	3MM
LUG HEIGHT	9MM
WEIGHT TOLERANCE / BEARING CAPACITY	400KG
OUTER DIAMETER	150MM
INNER DIAMETER	80MM
THICKNESS OF DRAINAGE CHANNELS	8MM PER CHANNEL (4 CHANNELS PER PAD)

## WEDGE SHAPED PVC SHIMS / SLOPE CORRECTORS FOR FIXED HEIGHT PADS

These PVC discs are similar to the 5mm PVC discs but are manufactured in a wedge shape.

They have a thickness which slopes from 3mm up to 8mm.

They can help to protect the waterproofing membrane beneath the pads and act as an acoustic layer.

They are also effective slope correctors for the fixed height pads keeping them vertical, arresting the falls of the deck beneath.

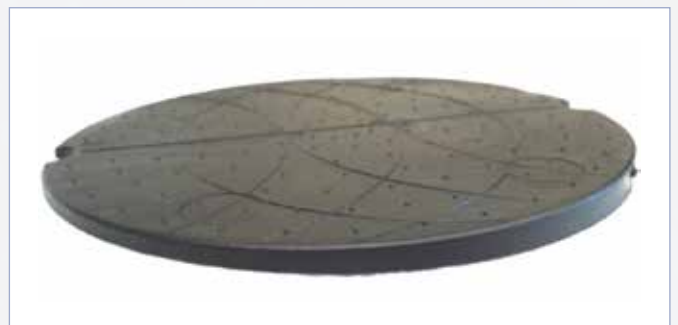

## ACCESSORIES FOR FIXED HEIGHT PADS

Fixed height paving pads often require levelling up in some sections, where the deck level changes at certain points across the roof. These minor changes can be addressed with the use of levelling shims.



1mm & 2mm shim



3mm shim

Levelling shims are manufactured 1mm, 2mm and 3mm thick and have been designed to fit on top of all fixed height support pads to make up those small differences in the level. Applicators can simply hang a levelling shim over the positioning lugs on the pad to make up the difference.



2mm shim on 9mm rubber pad



2mm shim snapped in half to prevent slab rocking



3mm shim on 14mm plastic pad

The shims will overhang the rubber ring slightly, but this is not an issue. The weight of the slab will ensure that the whole system is held in place properly. Multiple numbers of shims can be added to the pads, but care should be taken that the lug does not become engulfed as this will affect the paving guide.

All the shims can be snapped apart into a half shape or into quarters where only one corner needs extra support. This is often required where just one of the flags becomes unsteady and needs bringing up to the level of the others.



1mm, 2mm and 3mm shims can also be used on top of standard ASP headpieces on adjustable pedestals. Please see the section on ASP.



## RUBBER ACOUSTIC / ANTI-SHOCK SHIMS

The 2.5mm thick acoustic shims are an effective vibration or sound control layer. They can deaden the sound of pedestrian traffic over tiles or timber decking (very useful when terraces are being installed on top of dwellings below) and give extra protection.

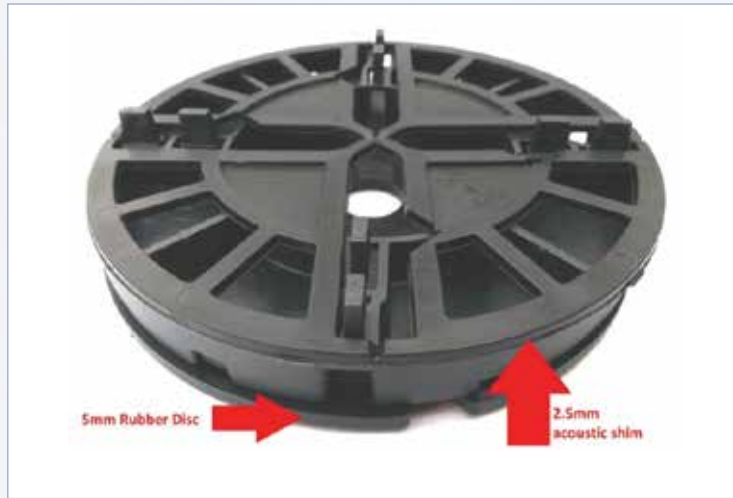

They are the same shape as the plastic 3mm shim, but are made from flexible PVC. The shock absorbing shims are loose fitted so no fixings or ties are needed. They are simply laid onto the pad / pedestal and hooked over the positioning lugs on the headpiece of the pad / pedestal. Installation is fast and easy.

The shims will also give extra protection to the slabs or tiles themselves, acting as a cushion between the slab and the plastic support pad / pedestal, reducing the risk of damage caused by vibration over time.



This can be of enormous benefit on housing projects, in particular where terraces or walkways are constructed on top of domestic properties, and can drastically improve the experience of residents.

Additional acoustic protection and insulation can be achieved by also loose fitting a 5mm rubber disc underneath the paving pad.

## TECHNICAL DATA

CODE	SP-PLA-001-SHIM	SP-PLA-002-SHIM	SP-PLA-003-SHIM	SP-RUB-0025	SP-RUB-003-Z
DESCRIPTION	1MM SHIM	2MM SHIM	3MM SHIM	SHOCK ABSORBING SHIM	RUBBER WEDGE SHIM
MATERIAL	INJECTION MOULDED POLYPROPYLENE			PVC RUBBER	
THICKNESS	1MM	2MM	3MM	2.5MM	3-8MM
WEIGHT TOLERANCE	400KG	400KG	400KG	8,000KG	8,000KG
OUTER DIAMETER	150MM	150MM	150MM	150MM	150MM

## MINIPADS FOR PAVING

Minipads are the ultra-low but fully adjustable pedestal for paving slabs. Installers had been asking for a further adjustment range on areas with very tight height thresholds, and given the popularity of the existing Minipads, a new design of pedestal has been developed which goes even lower.



This way, contractors can have millimetre exact adjustment from 10mm up to 25mm using these units. One or two 5mm thick plates are added to the units to increase the height. Each unit has a threshed stem to give precise and accurate height measurement.

The standard lug width is 2mm, but for schemes where larger gaps between slabs are required; 4mm, 6mm, 8mm and 10mm wide positioning lugs are available.

Should installers wish to arrest the fall or tilt of the pedestals, Wallbarn recommends using the rubber wedge 3-8mm shims placed under the bases.

## TECHNICAL DATA

CODE	HEIGHT	DIAMETER OF HEAD	DIAMETER OF BASE	DISTANCE BETWEEN LUGS	LUG HEIGHT	WEIGHT TOLERANCE*	MAXIMUM LOAD*	UNIT OF SALE INCLUDES
SP-MEG-010	10-20MM	150MM	150MM	60MM	15MM	683KG	1,171KG	PEDESTAL, HEADPIECE, 1 X 5MM EXTENSION PLATE
SP-MEG-010-25	10-25MM	150MM	150MM	60MM	15MM	683KG	1,171KG	PEDESTAL, HEADPIECE, 2 X 5MM EXTENSION PLATES
SP-MEG-022	22-30MM	150MM	150MM	60MM	15MM	683KG	1,171KG	PEDESTAL & HEADPIECE
SP-MEG-028	28-40MM	150MM	150MM	60MM	15MM	683KG	1,171KG	PEDESTAL & HEADPIECE

\* Weight tolerance = the point at which the pedestal ends its normal behaviour and starts to deform (according to CATAS test 179112/1)  
 Maximum load = the point at which pedestals start to collapse in laboratory tests (according to CATAS test 179112/1)

## MINIPADS FOR PAVING

The next sizes of Minipad are the 22-30mm and the 28-40mm. These have a slightly different design and a major advantage over the fixed height rings is that installers of suspended paving systems can twist the telescopic stem of these units to get the most minute and accurate adjustments in height.



Manufactured to a similar specification to the higher Megapad range featured later, but with a slightly lower weight tolerance of 683kg per unit Normal Weight Tolerance (end of linear behaviour) with a Maximum Load of 1171kg, these polypropylene units have a flat headpiece and base plate measuring 150mm in diameter. The lug separators are supplied as separate units which click into the central hole to provide the 2mm gap between paving slabs.



The integrated thread in the central column allows for height adjustment. The paving slab is laid onto the pad / pedestal and the head is twisted while the slab is in place. This avoids having to repeatedly lift heavy slabs when changing the height level.

It makes the installation process far faster and easier. The height can be finely tuned whilst the slab is in place whereas with fixed height pads, the slab needs to be constantly lifted and replaced to add levelling shims.

The standard lug width is 2mm, but for schemes where larger gaps between slabs are required; 4mm, 6mm, 8mm and 10mm wide positioning lugs are available.



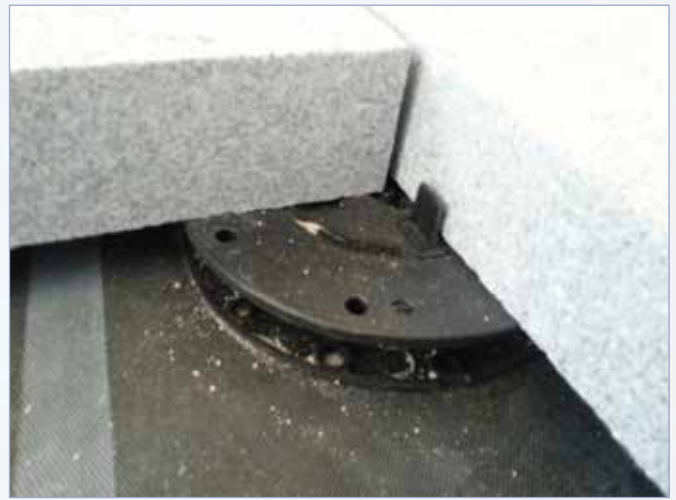
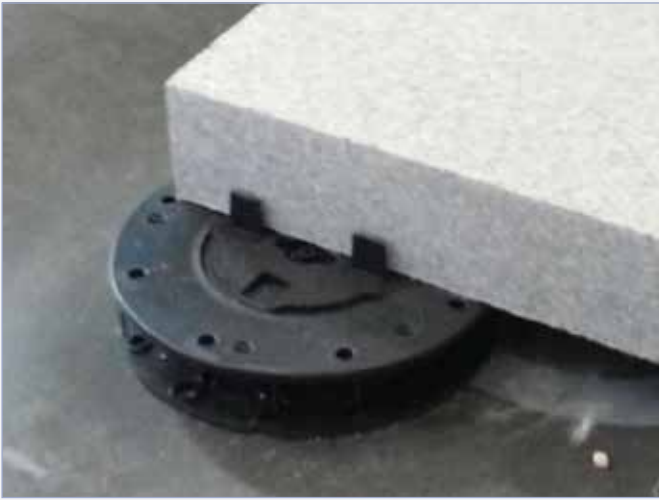

The underside of the pad is a smooth, solid, flat surface. The weight of the slab above can be evenly distributed across the 150mm diameter. This prevents point loading and any risk of the slabs digging into the surface beneath, a crucial consideration when installing slabs onto delicate waterproofing membranes or insulation.



## SLOPE CORRECTORS

On the underside there is a circular groove cut into the base where the Wallbarn slope correctors, featured on page 26, can be slotted into place. These take out the slope of the deck and ensure the Mini-Megapads sit exactly vertical and stable.

An alternative slope corrector is the rubber 3-8mm wedge shaped disc found on page 9. The Minipad will sit onto the rubber wedge without any fixing, but the weight of the slab should hold everything in place.

Of course these Minipads can also be fitted with TD headpieces for use with timber decking. Please see page 38 for more details.

## TECHNICAL DATA

CODE	SP-MEG-022	SP-MEG-028
HEIGHT	22-30MM	28-40MM
MATERIAL	INJECTION MOULDED POLYPROPYLENE	
LUG WIDTH	2MM STANDARD WIDTH (4MM, 6MM, 8MM & 10MM ALSO AVAILABLE)	
LUG HEIGHT	15MM	
DIAMETER OF HEAD	150MM	
DIAMETER OF BASE	150MM	
NORMAL WEIGHT TOLERANCE	683KG	
MAX LOAD	1171KG	
MAXIMUM TEMPERATURE	PLUS 75°C	
MINIMUM TEMPERATURE	MINUS 40°C	



## ASP ADJUSTABLE PAVING PEDESTALS / SUPPORT PADS

Best practice for roof and terrace design is to ensure the deck is built to a fall to allow proper drainage. To alleviate the fall across the area, for the very best results, applicators should use ASP adjustable height pedestals / support pads. ASP pedestals are ideal when a very high clearance is required across the area, where a large amount of adjustment is needed or very accurate and minor changes in the level are desired.

ASP pedestals have a very high height range, from 25mm up to 380mm (in the ASP EXTRA range).



ASP pedestals offer a major advantage over fixed height pads. More luxurious finishes are possible and they offer a far easier, faster and more effective method of laying suspended paving systems. Paving or decking tiles can be fitted up to the threshold level on roof decks or terraces without any risk of flooding.

The 2.2mm positioning lugs create a gap between each slab which allows rainwater to pass between and beneath them. These lugs give a clear paving line, so the slabs can be laid in a straight line quickly and easily.



This is a suspended system, so the pedestals are not fixed to the deck. This means there is no risk of the delicate waterproofing membrane beneath being pierced or damaged and warranties are unaffected. The weight of the slabs is spread through the base plates. If the deck ever needs to be inspected, the system can be taken up easily.

Wallbarn adjustable pedestals are made from injection moulded polypropylene. They have weight tolerance of 683kg per unit Normal Weight Tolerance (end of linear behaviour) with a Maximum Load of 1171kg and the strength and consistency have been tested in the laboratory at temperature ranges from +75° Celsius to -40° Celsius.

The cavity created allows the structure to ventilate more effectively. It allows a greater amount of water to pass into the drains without surface flooding. DPCs are not compromised as the slabs are not fixed to the walls.

Structural movement is not an issue as the slabs are not mortared together, so no cracks will appear.



This cavity also provides opportunities to hide unsightly objects, such as water pipes, electricity cables, drainage outlets and manholes beneath the paving slabs. Drainage outlets are unobstructed.

### ASSEMBLY

These robust pedestals / supports are manufactured from injection moulded polypropylene and can tolerate loads of 683kg per unit Normal Weight Tolerance (end of linear behaviour) with a Maximum Load of 1171kg. They also have a very large tolerance to temperature change and will not crack in freezing temperatures.

The large baseplate holds the stem and nut fixing in the central collar. The headpiece slots into the square indent pressed into the stem (the height of the pedestal is shown on the inside of the indent) and the whole unit is created.



The baseplate is manufactured with diagonal arms spreading out across the face of it. This ensures that the weight is spread to the maximum possible area and does not concentrate on the core.

The pedestal is placed down and the slab is laid on top of the head piece. With the slab in situ, installers use their fingers to twist the nut fixing on the stem up and down to adjust the height. There is no need to constantly remove and replace the slab.



If the height becomes very tight, installers can use the Wallbarn "Easykey" to help twist the nut fixing on the stem.



ASP pedestals are often used on the more high end projects, where designers and contractors wish to create seamless hard landscaping on roof decks where there may be multiple steps and ridges; where existing levels need to be matched, or where services and outlets need to be covered.



Even large differences in the height of the deck can be alleviated, creating one level across the whole area. By suspending the paving off the deck, truly beautiful finishes can be achieved on flat roofs and structural decks.



Slope correctors can be fitted to the baseplates of all ASP supports. Please see page 26 for more information.

### TRIMMING THE BASE PLATES

The base plates are manufactured with a series of guide lines, in case users wish to trim them. This may be required when paving up to the wall or around existing pipework or details.

The lines are marked as “Trim” lines, so installers can use an electric or handsaw to cut the bases back to the trim line, making the baseplate smaller.

It is important not to cut the bases any further than the level of the trim line as this will affect the stability of the pedestal.





## TECHNICAL DATA

MATERIAL	INJECTION MOULDED POLYPROPYLENE
NORMAL WEIGHT TOLERANCE	683KG
MAX LOAD	1171KG
MAX TEMPERATURE	PLUS 75 °C
MIN TEMPERATURE	MINUS 40 °C
BASE PLATE DIAMETER	200MM OR 150MM ❶
HEADPIECE DIAMETER	120MM
LUG HEIGHT	18MM OR 10MM ❷
LUG WIDTH / THICKNESS	2.2MM, 4MM, 6MM, 8MM, 10MM ❷
<b>CODE</b>	<b>DESCRIPTION / SIZE</b>
SP-ASP-025-FIXED	ASP 25MM FIXED PAD
SP-ASP-035-FIXED	ASP 35MM FIXED PAD
SP-ASP-035	35-50MM ASP ADJUSTABLE SUPPORT PAD
SP-ASP-050	50-70MM ASP ADJUSTABLE SUPPORT PAD
SP-ASP-065	65-100MM ASP ADJUSTABLE SUPPORT PAD
SP-ASP-095	95-130MM ASP ADJUSTABLE SUPPORT PAD
SP-ASP-125	125-160MM ASP ADJUSTABLE SUPPORT PAD
SP-ASP-155	155-190MM ASP ADJUSTABLE SUPPORT PAD
SP-ASP-185	185-220MM ASP ADJUSTABLE SUPPORT PAD
SP-ASP-210	210-245MM ASP ADJUSTABLE SUPPORT PAD
SP-ASP-240	240-275MM ASP ADJUSTABLE SUPPORT PAD
SP-ASP-270	270-305MM ASP ADJUSTABLE SUPPORT PAD
SP-ASP-300	300-335MM ASP ADJUSTABLE SUPPORT PAD
SP-ASP-330	330-365MM ASP ADJUSTABLE SUPPORT PAD
❶ PLEASE SEE SECTION ON MINI BASES	❷ PLEASE SEE SECTION ON HEADPIECES

## BALANCE ADJUSTABLE PEDESTALS FOR PAVING

Wallbarn announces the launch of its new BALANCE adjustable pedestals for paving. These specially designed self-levelling headpieces have been developed to give installers of paving slabs extra scope and flexibility to accommodate differences in the deck surface below the pedestal.

Sometimes blemishes and ridges in the sub-deck, or changes in thickness of the actual slab can make the upper surface uneven at certain points. The BALANCE adjustable pedestal for paving helps alleviate these issues.



This unique design is robust, stable and durable. The headpiece is composed of four separate parts which have been created to allow up to a 5% or 2.86° slope correction. The mechanism at the bottom of the headpiece allows smooth movement and positioning of the paving slab. Slips and sharp tilting are avoided owing to the superior design and solid manufacture. The headpiece section attached to this moving mechanism is 120mm in diameter with integrated positioning lugs moulded into it.

A PVC anti-shock slots onto the headpiece over a series of ridges to give better grip to the slab and to help insulate against vibration and noise travelling through the pedestal to the deck beneath. A fixing plug is set in the centre of the headpiece to lock all parts together.

These headpieces are substantial in size and 15mm thick, so the heights of the pedestals are different to the ASP range. A full table of the heights of the new BALANCE range are given overleaf.

## BALANCE EXTRA

'BALANCE pedestals are also available to accompany the EXTRA range. Again, the heights are different to those of the ASP EXTRA range. A full table of the heights of the new BALANCE EXTRA range are given overleaf.





## 25-50MM BALANCE ADJUSTABLE PEDESTALS

The BALANCE 25-50mm pedestal is a newly designed pedestal, which has been developed to make paving at low height thresholds easier for installers. The unique design incorporates a series of steps and notches moulded into the centre of the unit.



Set at 25mm on lower notches



Set at 50mm on highest notches and 2 extension plates

A small “PULL” tab on the side enables installers to open up the pedestal and set at different heights, depending on which sized notch they decide to connect together. Each setting is 5mm higher at each step. By changing the setting of the notches, installers can create a 25-30mm pedestal, a 30-35mm pedestal and a 35-40mm pedestal.

A telescopic thread is moulded into the centre of the unit to give very fine alteration in the height. The thread will give an additional 5mm of height range and users can be millimetre precise when turning the pedestal.

By adding special 5mm thick extension plates at the base, users can further increase the size, to 40-45mm and 45-50mm. The standard lug height is 10mm, to reflect the lower height threshold of the actual pedestal and the fact that often very thin tiles are used with these products. Alternative higher and thicker lugs can be used if required.

### TECHNICAL DATA

MATERIAL	INJECTION MOULDED POLYPROPYLENE
NORMAL WEIGHT TOLERANCE	683KG
MAX LOAD	1171KG
MAX TEMPERATURE	PLUS 75 °C
MIN TEMPERATURE	MINUS 40 °C
BASE PLATE DIAMETER	200MM OR 150MM ❶
EXTENSION PLATE SIZE	5MM THICK X 150MM DIAMETER ❷ – FOR BAL-025 ONLY
HEADPIECE DIAMETER	120MM
LUG HEIGHT	10MM
LUG WIDTH / THICKNESS	2MM STANDARD (4MM, 6MM, 8MM & 10MM AVAILABLE)
DEGREE OF SLOPE ON HEAD	5% - APPROX. 2.86°
<b>BALANCE PEDESTALS</b>	
<b>CODE</b>	<b>DESCRIPTION / SIZE</b>
SP-BAL-025	25-50MM BALANCE ADJUSTABLE PEDESTAL ❷
SP-BAL-047	47-62MM BALANCE ADJUSTABLE PEDESTAL
SP-BAL-062	62-82MM BALANCE ADJUSTABLE PEDESTAL
SP-BAL-077	77-112MM BALANCE ADJUSTABLE PEDESTAL
SP-BAL-107	107-142MM BALANCE ADJUSTABLE PEDESTAL
SP-BAL-137	137-172MM BALANCE ADJUSTABLE PEDESTAL
SP-BAL-167	167-202MM BALANCE ADJUSTABLE PEDESTAL
SP-BAL-197	197-232MM BALANCE ADJUSTABLE PEDESTAL
SP-BAL-222	222-257MM BALANCE ADJUSTABLE PEDESTAL
SP-BAL-252	252-287MM BALANCE ADJUSTABLE PEDESTAL
SP-BAL-282	282-317MM BALANCE ADJUSTABLE PEDESTAL
SP-BAL-312	312-347MM BALANCE ADJUSTABLE PEDESTAL
SP-BAL-342	342-377MM BALANCE ADJUSTABLE PEDESTAL
<b>BALANCE EXTRA</b>	
SP-BAL-EXTRA-097	97-147MM BALANCE EXTRA ADJUSTABLE PEDESTAL
SP-BAL-EXTRA-137	137-227MM BALANCE EXTRA ADJUSTABLE PEDESTAL
SP-BAL-EXTRA-222	222-392MM BALANCE EXTRA ADJUSTABLE PEDESTAL
❶ PLEASE SEE SECTION ON MINI BASES	

## FLAT HEADED ADJUSTABLE SUPPORTS

Wallbarn supplies a full range of flat headed adjustable pedestals in exactly the same heights as the ASP and ASP EXTRA ranges. When installing larger paving slabs; for example, those over 600mm, thinner tiles (such as 20mm thick tiles) or soft stones such as slate; just having a pad in each corner may not give sufficient support.



Users can lay a flat headed pedestal under the centre of these slabs to give additional support, eliminating the risk of breakages. They are manufactured in the same way as the ASP and ASP EXTRA ranges and match the technical specification in terms of weight and temperature tolerance. Cross spacers, as featured on page 2, can be used to provide spacing between slabs if required.

### TECHNICAL DATA

MATERIAL	INJECTION MOULDED POLYPROPYLENE
NORMAL WEIGHT TOLERANCE	683KG
MAX LOAD	1171KG
MAX TEMPERATURE	PLUS 75 °C
MIN TEMPERATURE	MINUS 40 °C
BASE PLATE DIAMETER	200MM OR 150MM ❶
HEADPIECE DIAMETER	120MM
<b>CODE</b>	<b>DESCRIPTION / SIZE</b>
SP-FLAT-025-FIXED	FLAT HEADED 25MM FIXED PAD
SP-FLAT-035-FIXED	FLAT HEADED 35MM FIXED PAD
SP-FLAT-035	35-50MM FLAT HEADED ADJUSTABLE SUPPORT PAD
SP-FLAT-050	50-70MM FLAT HEADED ADJUSTABLE SUPPORT PAD
SP-FLAT-065	65-100MM FLAT HEADED ADJUSTABLE SUPPORT PAD
SP-FLAT-095	95-130MM FLAT HEADED ADJUSTABLE SUPPORT PAD
SP-FLAT-125	125-160MM FLAT HEADED ADJUSTABLE SUPPORT PAD
SP-FLAT-155	155-190MM FLAT HEADED ADJUSTABLE SUPPORT PAD
SP-FLAT-185	185-220MM FLAT HEADED ADJUSTABLE SUPPORT PAD
SP-FLAT-210	210-245MM FLAT HEADED ADJUSTABLE SUPPORT PAD
SP-FLAT-240	240-275MM FLAT HEADED ADJUSTABLE SUPPORT PAD
SP-FLAT-270	270-305MM FLAT HEADED ADJUSTABLE SUPPORT PAD
SP-FLAT-300	300-335MM FLAT HEADED ADJUSTABLE SUPPORT PAD
SP-FLAT-330	330-365MM FLAT HEADED ADJUSTABLE SUPPORT PAD
SP-FLAT-EXTRA-085-Z	85-135MM EXTRA FLAT HEADED ADJUSTABLE SUPPORT PAD
SP-FLAT-EXTRA-125-Z	125-215MM EXTRA FLAT HEADED ADJUSTABLE SUPPORT PAD
SP-FLAT-EXTRA-210-Z	210-380MM EXTRA FLAT HEADED ADJUSTABLE SUPPORT PAD
❶ PLEASE SEE SECTION ON MINI BASES	



## ASP EXTRA EXTENDED RANGE OF HEIGHT PER UNIT

ASP EXTRA pedestals were developed due to feedback Wallbarn had received from customers. Clients asked for pedestals with a much greater amount of adjustment per unit and the ASP EXTRA range means that contractors can adjust from 85mm up to 380mm in only three different sized units.



When working on very large roofs or areas where the falls are not always consistent, installers require the added flexibility and scope to adjust pedestals by a far greater amount. This is often the case on refurbishment projects or roof decks which have steps or awkward changes in level. This makes the estimating process significantly easier and avoids having to swap sizes if the levels on site are different to the levels on the original drawings.

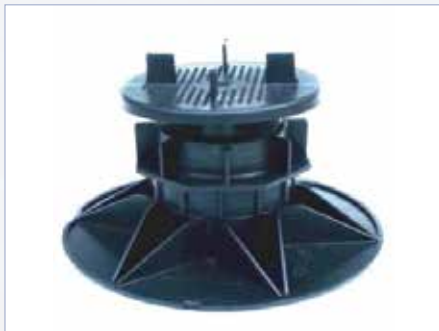

ASP EXTRA 85-135mm



ASP EXTRA 125-215mm



ASP EXTRA 210-380mm



## TECHNICAL DATA

MATERIAL	INJECTION MOULDED POLYPROPYLENE
NORMAL WEIGHT TOLERANCE	683KG
MAX LOAD	1171KG
MAX TEMPERATURE	PLUS 75 °C
MIN TEMPERATURE	MINUS 40 °C
BASE PLATE DIAMETER	200MM OR 150MM ❶
HEADPIECE DIAMETER	120MM
LUG HEIGHT	18MM OR 10MM ❷
LUG WIDTH / THICKNESS	2.2MM, 4MM, 6MM, 8MM, 10MM ❷
<b>CODE</b>	<b>DESCRIPTION</b>
SP-ASP-EXTRA-085-Z	85-135MM EXTRA ASP ADJUSTABLE SUPPORT PAD
SP-ASP-EXTRA-125-Z	125-215MM EXTRA ASP ADJUSTABLE SUPPORT PAD
SP-ASP-EXTRA-210-Z	210-380MM EXTRA ASP ADJUSTABLE SUPPORT PAD
❶ PLEASE SEE SECTION ON MINI BASES	❷ PLEASE SEE SECTION ON HEADPIECES

## MINI BASES – PAVING UP TO THE EDGE

Mini Bases have been developed so contractors can pave directly up to the wall or parapet effectively.

Mini Bases are designed for use with the ASP and ASP EXTRA range. They have a 150mm diameter base plate (the standard diameter baseplate is 200mm) which means the paving slab can be butted up against the upstand or parapet wall without a gap between that slab and the wall.



For best results, snap two of the positioning lugs off the head piece (or ask for the special 2 lugged headpiece from Wallbarn) and lay only the corners of two slabs – rather than four – onto the headpiece.

The slabs are properly supported and stable. There is no risk of the slab tipping up as it is not overhanging.

The baseplates will fit any height of ASP or ASP EXTRA pedestal. The strength and weight tolerance is the same as with the standard bases. Point loading is slightly increased, however.



Ask for MINI BASES for edges, parapets and perimeters.

## TECHNICAL DATA

MATERIAL	INJECTION MOULDED POLYPROPYLENE	
NORMAL WEIGHT TOLERANCE	683KG	
MAX LOAD	1171KG	
MAX TEMPERATURE	PLUS 75 ° C	
MIN TEMPERATURE	MINUS 40 ° C	
BASE PLATE DIAMETER	150MM	
HEADPIECE DIAMETER	120MM	
LUG HEIGHT	18MM OR 10MM ②	
<b>CODE</b>	<b>DESCRIPTION</b>	<b>SUITABLE FOR</b>
SP-BASE-MB-025	SMALL MINI BASE PLATE - 150MM DIAMETER	ASP 25MM FIXED & ASP 35-50MM
SP-BASE-MB-035	LARGE MINI BASE PLATE - 150MM DIAMETER	ASP 35MM FIXED & ASP 50MM AND ABOVE (INC ASP EXTRA)
② PLEASE SEE SECTION ON HEADPIECES		



## METAL EDGING PLATE FOR PAVING

Wallbarn is introducing a new tool in 2017 to help installers of paving set their slabs directly up to the wall. The new Metal Edging Plate is a supporting beam which is laid onto the headpiece of ASP or Megapad pedestals to support the end paving slab when it is butting directly against the wall or parapet.

The plate has a raised edge which butts against it and braces the slab against the wall effectively.



The plate is held down by the weight of the two slabs laid on top of it and the pedestal and by jutting out it will support the two slabs which hang out over the headpiece of the pedestal. This removes any risk of the slabs tipping up if people stand on the very edge of them.



**Ask Wallbarn for more details on the edging plates and best practice for paving to walls and exposed ledges.**

## DIFFERENT HEADPIECES FOR ASPs

Wallbarn offers a variety of headpieces, suitable for a number of different applications. All the headpieces are made from the same virgin fibre polypropylene as the other components of the ASP units.

The STANDARD ASP HEADPIECE for ASP adjustable pedestals is the most common type of headpiece used for paving schemes. It measures 120mm diameter and has four lug fittings 2.2mm wide and 18mm high. This will hold a 50mm slab in place effectively and gives a sufficient amount of drainage between slabs. Wallbarn can offer variations to this standard headpiece, according to the needs of the client.

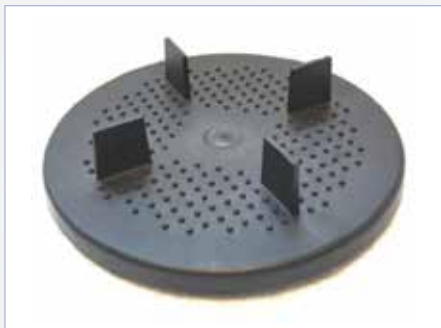

STANDARD ASP HEADPIECE  
Lug size: 2.2mm thick  
18mm high

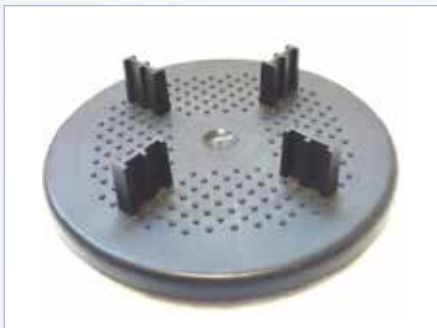

4MM THICK LUGGED HEADPIECE  
Lug size: 4mm thick  
18mm high

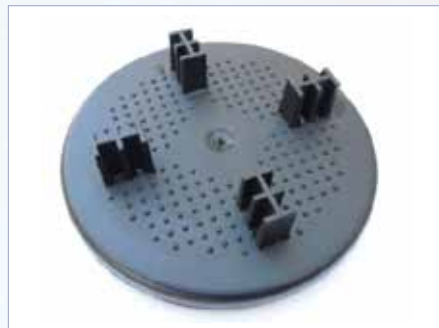

10MM THICK LUGGED HEADPIECE  
Lug size: 10mm thick  
18mm high

If installers require a larger gap between the paving slabs, a 4mm thick Lugged Headpiece can be supplied which will allow a greater amount of water to pass through the gaps. This may be required where, for example; installers need to match up to an existing paving scheme using the 9mm rubber pads (on page 5).

A 6mm thick Lugged Headpiece (not pictured) and a 10mm thick Lugged Headpiece is also available, although designers should be sure that such a large gap does not present a trip hazard in some instances.



SHORT LUGGED HEADPIECE  
Lug size: 2.2mm thick  
10mm high



2 LUGGED HEADPIECE  
Lug size: 2.2mm thick  
18mm high



FLAT HEADED HEADPIECE  
Zero Lugs

Where thinner slabs are being installed, such as porcelain tiles (which can typically be 20mm thick); the standard height lugs may be too visible for a truly fine finish. A SHORT LUGGED HEADPIECE, with 10mm high lugs, is available should this be the case.

**2 LUGGED HEADPIECES** can be used if irregular paving patterns are being laid, such as stretcher or half-bond schemes. The slab will need supporting not only at all four corners but also at every junction point, in a T junction or across a larger span. In these instances, this 2 lugged headpiece can be fitted onto the pedestal to allow adequate support at the edge.

These headpieces are also useful when paving directly up the parapet wall, where two slab corners, rather than the usual four, need to be supported. Please see the section on MINI BASES.

**FLAT HEADED HEADPIECES** are used if very large paving slabs are being installed and need additional support under the centre. Also, where very thin tiles or more delicate / soft stones are being laid (such as slate), then it is recommended that an additional pedestal is placed underneath the centre of the slab to give added support. The headpiece is completely flat, so will not scratch the paving or interfere with the levels.

For further information see section on FLAT HEADED ADJUSTABLE SUPPORTS.



## SLOPE CORRECTORS FOR ASP & MEGAPAD PEDESTALS

Slope correctors are wedge shaped plastic levellers which are clipped or fitted onto the base plate of adjustable pedestals. They are suitable for use with ASP, TD and Megapad supports; including the new mini-Megapads, ASP MBs with the 150mm diameter base plate, the ASP and TD EXTRA range.

Slope correctors are available in three sizes, with a 1%, 2% and 3% gradient.



They are designed to arrest the fall of the roof or deck beneath – even “flat roofs” will be built to a fall for drainage. By having these wedges attached underneath, the support pads remain completely vertical and straight, which ensures the force of gravity runs directly vertical (see purple arrows below), preventing tilting and keeping the support pad more stable.

They are very easy to apply to the base plate. For the 200mm diameter base plates, two simple clips (green arrows) fix around the lip of the baseplate. All 150mm base plates have a groove inside the perimeter which slots into a series of ridges (red arrows) situated on the inner ring of the slope corrector.

More than one slope corrector can be applied if required as one can clip onto another very easily. Wallbarn recommends that pedestals are used on roof decks with a maximum slope of 10%.

The gradient or slope is measured as a percentage. The deck is most commonly laid to a fall around 1 in 40, so a 2% slope corrector is normally chosen.



## TECHNICAL DATA

MATERIAL	INJECTION MOULDED POLYPROPYLENE	
MAX TEMPERATURE	PLUS 75 °C	
MIN TEMPERATURE	MINUS 40 °C	
OUTER DIAMETER	200MM	
INNER DIAMETER	82MM	
<b>CODE</b>	<b>DESCRIPTION</b>	<b>SUITABLE FOR</b>
SP-ASP-SLOPE001	1 PERCENT SLOPE CORRECTOR	ASP, ASP EXTRA, MEGAPAD, MINI-MEGAPADS  TD, TD PLUS, TD MOBILE, TD MEGAPAD
SP-ASP-SLOPE002	2 PERCENT SLOPE CORRECTOR	
SP-ASP-SLOPE003	3 PERCENT SLOPE CORRECTOR	

## MEGAPADS FOR PAVING

Some decks require a very high cavity beneath the paving slab, and there can be complicated areas where large steps and different levels are present across the deck. Often, large services such as pipework and machinery, ducts and drainage channels need to be covered. Megapads are the optimum product for such areas.



Megapads are the heavy duty range of pedestals which are available in heights up to 1020mm. They are extremely tough and hard wearing with a weight tolerance of 1560kg per unit Normal Weight Tolerance (end of linear behaviour) with a Maximum Load of 2057kg. They are ideal for holding up truly massive and very heavy slabs.



The larger Megapads also have an extended height range of 105mm each. This means fewer different sizes to order when installing across a large area.

They create a large cavity between the deck surface and the underside of the slab, which helps to ventilate the area and prevent issues such as rising damp and water getting clogged beneath the slab. Slabs are also well away from drains, outlets and pipework.

They are also resilient to very high and very low temperatures. They have been used successfully in some of the coldest populated regions on earth.



**ASSEMBLY (215MM AND HIGHER)**

Megapads are made up of multiple sections, which lock together to form one, sturdy unit.



At 215mm and higher, Megapads are increased in height by adding a 100mm high EXTENSION TOWER.

These towers click into the baseplate and to each other (if required) so multiple towers can be added to the Megapad, increasing the height up to a maximum of 1020mm.

When installing slabs, users should set out the Megapads at around the correct height, lay the slab down and then make final adjustments by hand. Their superior strength and flexibility mean that installers can adjust the height of the pedestal whilst the slab is in situ. This avoids having to repeatedly lift the slab to adjust the levels, a huge advantage when using very large or very heavy slabs.





## LOCKING THE HEIGHT

At 35mm and above, Megapads are designed to be “locked” into place once the correct height has been achieved with the ingeniously designed double-locking- thread mechanism. The headpiece, the extension towers and baseplate connect together by screwing into each other in the usual manner (green arrows).

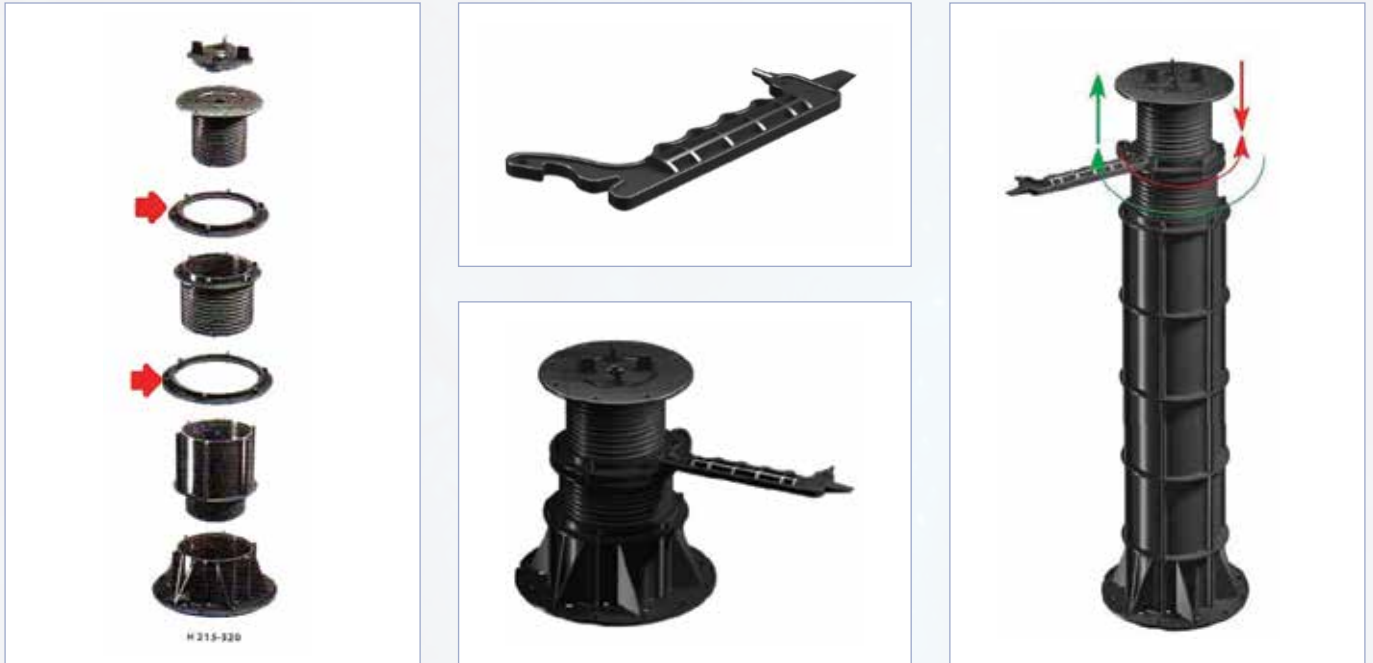

As the extension tower, adjustable thread section and headpiece are all screwed into place, a locking ring section (red arrows) is counter threaded at two points up to the headpiece and at the bottom of the stem, linking either to the baseplate or an extension collar.

A special “Easykey” tool is used to help act as a wrench to ensure the locking nut is tightly screwed into place. The grooves in the handle fit around bars moulded onto the locking ring to give extra leverage when tightening them.

Once these locking rings are secured in place, the pedestals cannot change in height or start to unwind. The “Easykey” is again used to release the locking ring. It is pressed into a small hole to release a spring within the unit, allowing the threads to be unlocked and untwisted, should installers wish to change the height at a later date.

## PAVING UP TO THE EDGE – MEGAPADS ARE REVERSIBLE

At 115mm high and above, the unit can be inverted. When paving up to the edges, up to balustrades and railings, or around corners; the very edge of the slab needs to be properly supported to prevent that slab tipping if weight is placed onto the lip. The support pad can be turned upside down and the lug head unit placed into what was the base plate.



Since the base plate is 200mm in diameter, when turned upside down, the new headpiece is 200mm in diameter, wider than the new base plate. Therefore, the paving slab sits securely onto the wider headpiece and does not overhang the supporting columns. This means the slabs are fully supported and can be butted up against the wall without risk of tipping. Even at their maximum height these supports are stable and secure.

## SHOCK ABSORBING SHIMS

For additional acoustic properties, or if more grip is needed, TPE shock absorbing shims can be installed onto the headpiece of Megapads.

The shim will hook over the positioning lugs so that it sits securely in place.

Please see the accessories section for more details.



## SLOPE CORRECTORS

The base plates come with clip fixings to allow slope correctors to be fitted. These wedge shaped levellers help prevent tilting of the units when placed on the built-to-falls decks.

The Megapad remains completely vertical with its centre of gravity going directly through the middle of the unit. This keeps the slabs on top completely stable.



## TECHNICAL DATA

MATERIAL	INJECTION MOULDED POLYPROPYLENE
NORMAL WEIGHT TOLERANCE	1560KG
MAX LOAD	2057KG
MAX TEMPERATURE	PLUS 75 °C
MIN TEMPERATURE	MINUS 40 °C
BASE PLATE DIAMETER	200MM
HEADPIECE DIAMETER	150MM
LUG HEIGHT	15MM
LUG WIDTH / THICKNESS	2MM, 4MM, 6MM, 8MM OR 10MM
<b>CODE</b>	<b>DESCRIPTION / SIZE</b>
SP-MEG-010 ①	MEGAPAD 10-20MM - SEE MINI MEGAPAD PAGE
SP-MEG-022 ①	MEGAPAD 22-30MM - SEE MINI MEGAPAD PAGE
SP-MEG-028 ①	MEGAPAD 28-37MM - SEE MINI MEGAPAD PAGE
SP-MEG-035	MEGAPAD 35-50MM
SP-MEG-050	MEGAPAD 50-75MM
SP-MEG-075	MEGAPAD 75-120MM
SP-MEG-115	MEGAPAD 115-220MM
SP-MEG-215	MEGAPAD 215-320MM
SP-MEG-315	MEGAPAD 315-420MM
SP-MEG-415	MEGAPAD 415-520MM
SP-MEG-515	MEGAPAD 515-620MM
SP-MEG-615	MEGAPAD 615-720MM
SP-MEG-715	MEGAPAD 715-820MM
SP-MEG-815	MEGAPAD 815-920MM
SP-MEG-915	MEGAPAD 915-1020MM
① 683KG WEIGHT TOLERANCE, 150MM BASE - PLEASE SEE SECTION ON MINI BASES FOR FULL TECHNICAL DATA	

## EDGING & CREATING STEPS

### METAL PLATES FOR CREATING STEPS ON PAVING

Metal clips can be used as a useful tool for edges and step details for paving.

If users wish to install a vertical section of stone or porcelain, two clips are available to hold it in place on the vertical plane. These clips can be used with ASP and Megapad pedestals.

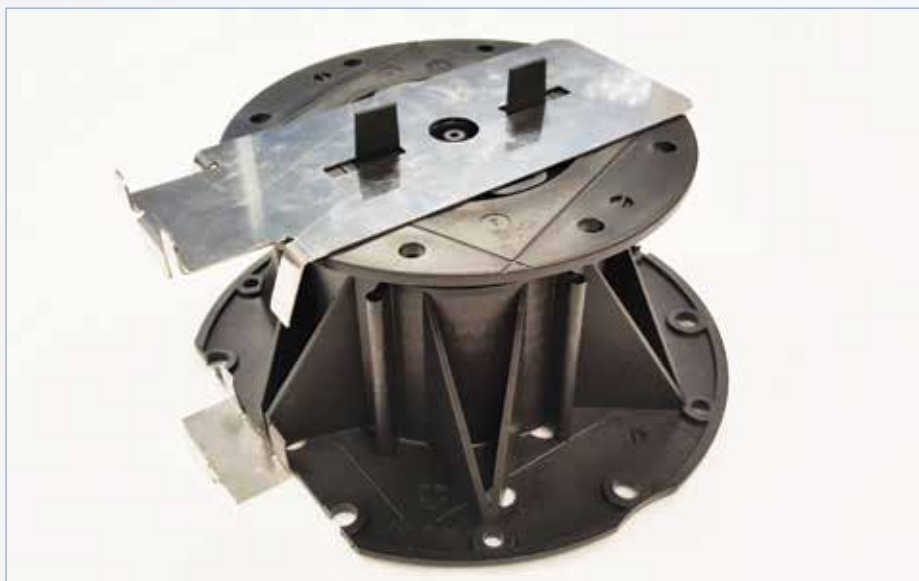

These clips hold a vertical board or tile in place in front of the pedestal, acting as a skirting / edging board. Areas where a step is created will expose the underside of suspended paving, including the black pedestal. These clips were developed to cover all the workings on the underside of the paving slabs and achieve a tidy finish.



METAL CLIP FOR ABOVE JOIST – CLIP A

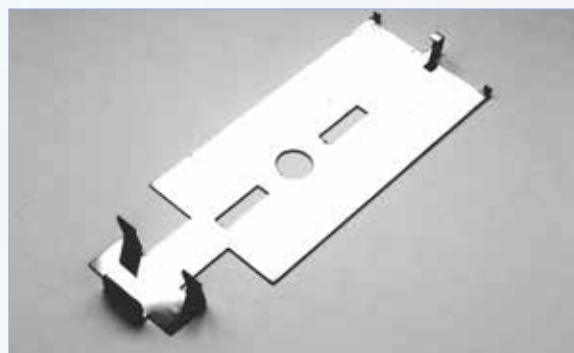

METAL CLIP FOR UNDER BASEPLATE – CLIP B

The baseplate of the pedestal needs to be cut back slightly to accommodate the spring-loaded fasteners at the front of the baseplate clip (CLIP B). At the back of this clip there are three grips which will hold the baseplate securely.

### CLIP FOR BASEPLATE – CLIP B

Clip B is fitted underneath the baseplate of the adjustable pedestal, which has been cut back slightly to the size of Clip B. This clip has small grips at each end which will hold the baseplate securely and a further set of bars which point upwards, ready to hold the vertical edging board / tile.

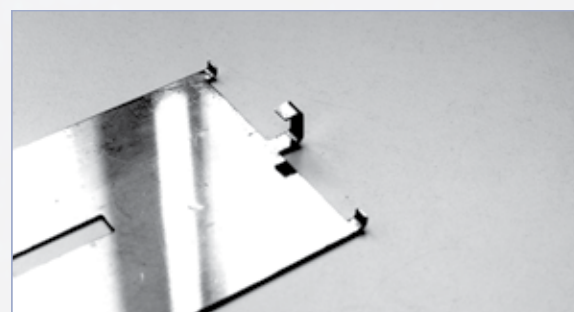



## CLIP FOR HEADPIECE – CLIP A

The upper clip (clip A) rests on top of the headpiece of the adjustable pedestal and the weight of the paving slab or decking board on top holds it in place.

The clip is sandwiched between the headpiece of the pedestal and the slab / board, safely wedged and ballasted by the weight of the covering.

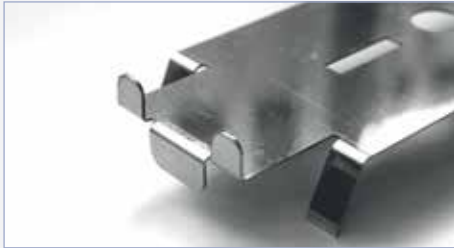

The vertical edge / skirting board is fitted in place and secured both top and bottom by the upwards and downwards pointing grips. The pedestal and joist beneath are covered and the finish is clean and tidy.

**Using these metal clips is not a substitute for fitting a proper, structural termination section. These clips will hold fascia boards and vertical sections in place but the strength of these fixings is limited, so Wallbarn would recommend a structural section set into the slab to hold the decking in place if considerable traffic onto steps and termination details is anticipated.**

## FIXING PEDESTALS IF REQUIRED

If a moderate level of traffic on these step details is anticipated, to hold the pedestals more securely, a suggestion is to bond the pedestals, be that TD Supports or TD Megapads, more securely to the subdeck. This will hold the decking or paving stable and secure at this exposed edge and prevent the pedestals and decking moving over time.



The best option is to use TD Megapads which have holes around the circumference where a mechanical fixing and / or adhesive can be set through the holes to ensure the unit does not move over time.

**Ask Wallbarn for more details of the new edging clips.**

## TIMBER DECKING

Many roof decks, terraces and walkways are constructed with a timber decking surface. Where the decking is built onto waterproofing, however, it is important that the timber does not come into direct contact with waterproofing membrane.

Wallbarn has developed a range of pads and pedestals to raise the timber decking off the roof deck. These pads and pedestals provide proper drainage, preventing the timber digging into the membrane; and keeping the wood out of standing water, helping to prevent rotting.



The supports are manufactured with a specially designed headpiece to hold timber joists. These are typically 60mm apart which will allow a 2 inch joist or batten to fit in between the pegs / lugs easily.



The supports are not drilled or bonded to the deck and the joists sit on them without being fixed. Once the battens are placed onto the headpieces, they are joined together to form a joist framework.

**The battens / joists should be laid onto the supports no more than 600mm apart to avoid any risk of point loading of weight or the timber bouncing.**

The decking boards are then fixed to the joist frame. It is designed to be loose fitted. This allows for movement.

The void between the decking and the roof ventilates the roof-deck and also means the void can be used to hide items such as water pipes, electrical wiring and drains.

## 5MM PVC PADS

Where users need the very minimum amount of height off the surface when installing timber decking systems, the plain fixed height 5mm PVC paving pad can be considered.



These ultra-thin paving pads give the minimum lift off the deck required for drainage. It is important to separate the timber from the membrane beneath to prevent damage.

The circular pad is manufactured from PVC into a 150mm diameter disc. The upper surface is flat. There is no adjustment in height possible using this product. The disc is used more as a separation and protection layer than a pedestal.

## TECHNICAL DATA

5MM THICK PVC SUPPORT DISC	
CODE	SP-RUB-005
MATERIAL	PVC
THICKNESS / HEIGHT OFF SURFACE	5MM
WEIGHT TOLERANCE / BEARING CAPACITY	8,000KG
OUTER DIAMETER	150MM
APPEARANCE	FLAT DISC BOTH SIDES





## 7MM PVC PADS FOR DECKING

The next height of timber decking supports is the fixed height 7mm PVC decking pad. Imperial measurements are also included on the PVC discs. The disc is approximately ¼ inch thick. The exact measurement is 0.276 “.

These discs have been specially designed to improve drainage even at these very low heights.



These circular pads are manufactured from PVC into 150mm diameter discs. The upper surface is moulded into a series of circular ridges and grooves which encourages the rainwater to run off the surface of the pad. Water will not be held on the surface of the disc, which means there is less risk of standing water affecting the timber joists in the long term.



There is no mechanical fixing required, the weight and stability of the frame will hold everything secure and in place.

The PVC compound means these pads have a soft, flexible, hard-wearing profile; helping to protect the membrane beneath from damage. PVC will also offer acoustic properties and create a separation layer from the deck. They are extremely tough and durable and will also not become brittle in cold weather.

These pads are ideal for refurbishment projects, where an existing surface or system is overlaid.

## TECHNICAL DATA

CODE	SP-RUB-007-DECKING
MATERIAL	PVC
THICKNESS / HEIGHT OFF SURFACE	7MM
DISTANCE BETWEEN LUGS	60MM
LUG HEIGHT	15MM
WEIGHT TOLERANCE / BEARING CAPACITY	8,000KG
OUTER DIAMETER	150MM
NUMBER OF DRAINAGE HOLES	6

## TD PLUS HEADPIECE FOR 7MM PVC PAD

The alternative TD Plus headpiece is also used for the 7mm PVC disc. Installers can screw the timber joists in place through the side bars if they wish to more fully secure the framework.



## TECHNICAL DATA

CODE	SP-RUB-007-DECKING TD PLUS
MATERIAL	PVC
THICKNESS / HEIGHT OFF SURFACE	7MM
FIXING POINTS ON LUGS	2
LUG HEIGHT	30MM
WEIGHT TOLERANCE / BEARING CAPACITY	8,000KG
OUTER DIAMETER	150MM
NUMBER OF DRAINAGE HOLES	6





## TD MINIPADS

TD Minipads are the ultra-low but fully adjustable pedestal for timber decking. Installers had been asking for a further adjustment range on areas with very tight height thresholds, and given the popularity of the existing TD Minipads, a new design of pedestal has been developed which goes even lower.



This way, contractors can have millimetre exact adjustment from 10mm up to 25mm using these units. One or two 5mm thick plates are added to the units to increase the height. Each unit has a thashed stem to give precise and accurate height measurement.

The standard lug width is 2mm, but for schemes where larger gaps between slabs are required; 4mm, 6mm, 8mm and 10mm wide positioning lugs are available.

Should installers wish to arrest the fall or tilt of the pedestals, Wallbarn recommends using the rubber wedge 3-8mm shims placed under the bases.

## TECHNICAL DATA

CODE	HEIGHT	DIAMETER OF HEAD	DIAMETER OF BASE	DISTANCE BETWEEN LUGS	LUG HEIGHT	WEIGHT TOLERANCE*	MAXIMUM LOAD*	UNIT OF SALE INCLUDES
SP-TD-MEG-010	10-20MM	150MM	150MM	60MM	15MM	683KG	1,171KG	PEDESTAL, HEADPIECE, 1 X 5MM EXTENSION PLATE
SP-TD-MEG-010-25	10-25MM	150MM	150MM	60MM	15MM	683KG	1,171KG	PEDESTAL, HEADPIECE, 2 X 5MM EXTENSION PLATES
SP-TD-MEG-022	22-30MM	150MM	150MM	60MM	15MM	683KG	1,171KG	PEDESTAL & HEADPIECE
SP-TD-MEG-028	28-40MM	150MM	150MM	60MM	15MM	683KG	1,171KG	PEDESTAL & HEADPIECE

\* Weight tolerance = the point at which the pedestal ends its normal behaviour and starts to deform (according to CATAS test 179112/1)  
Maximum load = the point at which pedestals start to collapse in laboratory tests (according to CATAS test 179112/1)

## TD MINIPADS

The next fully adjustable timber decking pedestals are the TD Minipads 22-30mm and 28-40mm which give further height ranges to support timber joists at very low thresholds.



Made from injection moulded polypropylene (PP), these support pads are extremely tough and strong. They can tolerate 683kg per unit Normal Weight Tolerance (end of linear behaviour) with a Maximum Load of 1171kg, and can withstand vast temperature changes – from plus 75°C to minus 40°C – without cracking or losing their bearing capacity.

The headpiece and baseplate are 150mm in diameter and the head has a joist holder which clips into the centre of the unit. The housing lugs are placed 60mm apart, so a timber joist can be placed on the headpiece between the lugs and be held securely.



Using TD Minipads means that installers do not need to spend time and effort placing shims under fixed height pads. The units can be twisted with the joists in place to alter the height. That way, the timber joist frame, which is constructed to hold the deck boards in place and provide a solid structure, is completely flat and level.

The decking will therefore be completely flat, giving a much higher quality appearance.



## TECHNICAL DATA

CODE	SP-TD-MEG-022	SP-TD-MEG-028
HEIGHT	22-30MM	28-40MM
MATERIAL	INJECTION MOULDED POLYPROPYLENE	
WIDTH BETWEEN LUGS	60MM	
LUG HEIGHT	15MM	
DIAMETER OF HEAD	150MM	
DIAMETER OF BASE	150MM	
NORMAL WEIGHT TOLERANCE	683KG	
MAX LOAD	1171KG	
MAXIMUM TEMPERATURE	PLUS 75°C	
MINIMUM TEMPERATURE	MINUS 40°C	

## ADJUSTING THE MINIPAD

Because the amount of adjustable thread is so small – only 8mm in the case of the SP-TD-MEG-022 – it is sometimes difficult for applicators to get their fingers into the space to alter the height.

Wallbarn has an “Easykey” tool which can be used as a wrench. One end of the key is placed around the vertical bars on the stem section and the key can then be used as a wrench to turn the stem and adjust the height of the Minipad.

## SLOPE CORRECTORS

Slope correctors (found on page 59) can be used with TD Minipads. Although the slope correctors have a larger diameter than the Minipads, there are a series of ridges moulded into the slope corrector on the inner rim.

These ridges click onto grooves on the baseplate of the Minipad, aligning them securely into place. This means the Minipad will be vertical and completely stable.





## TD SUPPORT PADS FOR DECKING

Timber decking is constructed on a considerable amount of roofs, terraces and walkways. Timber decking can provide beautiful, natural looking spaces in urban areas and complement soft landscaping very well. The waterproofing of these roofs and terraces are very important. Care must be taken to protect these often delicate membranes as warranties are often at stake. Simply laying timber directly onto the membrane runs too much risk of damage.



Wallbarn's TD range was developed to provide a solution to this problem. The strong polypropylene pads lift the decking off the roof deck. This offers the following advantages: allowing proper drainage of the decking surface therefore reducing slip hazards, preventing the timber digging into the membrane beneath, keeping the wood out of standing water.

These adjustable supports have a specially designed headpiece with pegs positioned in the corners, either 40mm or 60mm apart. This means a 2 inch joist or batten can fit in between the pegs / lugs easily and there is a little extra room in case the timber joist is not completely straight and to allow movement.



Installation using this system is simple – the pads are loose laid onto the deck; the telescopic stems are adjusted to ensure the upper surface is level; a joist framework is constructed on top of the supports (cross battens are screwed into place to give a framework which is sturdy and weight bearing) and the top layer of decking boards are fixed to the joist frame.

**Wallbarn recommends that the TD Support Pads are sited no more than 600mm apart.**

There is no risk of them moving off the head piece and no bonding or fixings onto the support itself are required. There is no need to mechanically fix the supports into the membrane; this is a completely free standing system.

The battens / joists are suspended off the deck, meaning none of the wood is exposed to standing water, which can rot the timber. Also, the joists are not lying directly on the waterproofing membrane, which can often damage the membrane. The weight of the whole timber deck is distributed through the wide baseplates. This prevents digging into the surface beneath and helps to make the whole decking structure more stable.



## ASSEMBLY

Assembly of the TD range is the same as with the ASP range. The large baseplate holds the stem and nut fixing in the central collar. The headpiece slots into the square indent pressed into the stem (the height of the pedestal is shown on the inside of the indent) and the whole unit is created.



The baseplate is manufactured with diagonal arms spreading out across the face of it. This ensures that the weight is spread to the maximum possible area and does not concentrate on the core.

Installers use their fingers to twist the nut fixing on the stem up and down to adjust the height. There is no need to constantly remove and replace the timber joist. The joists rest on top of the headpiece between the housing lugs / pegs located on the edge.



There are a series of "Trim" marks on the base plate (see page 17 for more details) should installers wish to trim them back around corners of details. This is less of an issue than for paving, however, as the timber joist can easily overhang the headpiece.



Installers can adjust the height of the pedestals whilst the timber joists are in place on the headpieces. The best method is to suspend the joist at each end onto the pedestals, check the level is correct with a laser or spirit level and then add extra pedestals across the length of the joist to give sufficient support (no more than 600mm apart). This is a fast and easy process.



The void between the decking and the roof can be used to hide items such as water pipes, electrical wiring and drainage outlets. Drainage is uninterrupted, a major advantage.



Wallbarn TD pedestals are suitable for treated softwood, tropical hardwood and composite decking systems. Our products are the pedestal of choice for a number of high-end, patented decking systems in the UK and worldwide.







Pressure treated softwood – social housing project refurbishment – roof terrace



Yellow Balau tropical hardwood fixed to treated softwood joists – office development, City of London



Composite decking fixed to 6 x 2" joists – office refurbishment project, London



## TECHNICAL DATA

MATERIAL	INJECTION MOULDED POLYPROPYLENE
NORMAL WEIGHT TOLERANCE	683KG
MAX LOAD	1171KG
MAX TEMPERATURE	PLUS 75 °C
MIN TEMPERATURE	MINUS 40 °C
BASE PLATE DIAMETER	200MM OR 150MM ❶
HEADPIECE DIAMETER	120MM
WIDTH BETWEEN LUGS	60MM OR 40MM
LUG HEIGHT	18MM
<b>CODE</b>	<b>DESCRIPTION / SIZE</b>
SP-TD-025-FIXED	TD 25MM FIXED HEIGHT TIMBER DECKING PAD
SP-TD-035-FIXED	TD 35MM FIXED HEIGHT TIMBER DECKING PAD
SP-TD-035	35-50MM TD TIMBER DECKING PAD
SP-TD-050	50-70MM TD TIMBER DECKING PAD
SP-TD-065	65-100MM TD TIMBER DECKING PAD
SP-TD-095	95-130MM TD TIMBER DECKING PAD
SP-TD-125	125-160MM TD TIMBER DECKING PAD
SP-TD-155	155-190MM TD TIMBER DECKING PAD
SP-TD-185	185-220MM TD TIMBER DECKING PAD
SP-TD-210	210-245MM TD TIMBER DECKING PAD
SP-TD-240	240-275MM TD TIMBER DECKING PAD
SP-TD-270	270-305MM TD TIMBER DECKING PAD
SP-TD-300	300-335MM TD TIMBER DECKING PAD
SP-TD-330	330-365MM TD TIMBER DECKING PAD
❶ PLEASE SEE SECTION ON MINI BASES	



## TD EXTRA SUPPORT PADS FOR DECKING

As with the ASP EXTRA pedestals for paving, Wallbarn has developed support pads with a much larger height range for timber decking also. Therefore, when installing decking, users can adjust from 85mm up to 380mm in only three different sized units.



## TECHNICAL DATA

MATERIAL	INJECTION MOULDED POLYPROPYLENE
NORMAL WEIGHT TOLERANCE	683KG
MAX LOAD	1171KG
MAX TEMPERATURE	PLUS 75 °C
MIN TEMPERATURE	MINUS 40 °C
BASE PLATE DIAMETER	200MM OR 150MM ❶
HEADPIECE DIAMETER	120MM
WIDTH BETWEEN LUGS	60MM OR 40MM
LUG HEIGHT	18MM
<b>CODE</b>	<b>DESCRIPTION</b>
SP-TD-EXTRA-085-Z	85-135MM EXTRA TD TIMBER DECKING PAD
SP-TD-EXTRA-125-Z	125-215MM EXTRA TD TIMBER DECKING PAD
SP-TD-EXTRA-210-Z	210-380MM EXTRA TD TIMBER DECKING PAD
❶ PLEASE SEE SECTION ON MINI BASES	



## 90MM WIDE TD HEADPIECES

A special headpiece is available with housing lugs placed 90mm apart. These units may be required where a larger timber joist is being laid onto the pedestal.



Having a larger timber joist means that the whole decking system is stronger and more stable, and potentially more weight can be loaded onto it.

However, care must be taken to ensure that the additional weight of the joist structure or whatever is placed onto the decking does not overload the whole system. Although the pedestals will tolerate 683kg per unit Normal Weight Tolerance (end of linear behaviour) with a Maximum Load of 1171kg, Wallbarn always recommends that pedestals are placed no more than 600mm apart when constructing timber decking areas.

## TECHNICAL DATA

MATERIAL	INJECTION MOULDED POLYPROPYLENE
NORMAL WEIGHT TOLERANCE	683KG
MAX LOAD	1171KG
MAX TEMPERATURE	PLUS 75 °C
MIN TEMPERATURE	MINUS 40 °C
BASE PLATE DIAMETER	200MM OR 150MM ❶
HEADPIECE DIAMETER	120MM
WIDTH BETWEEN LUGS	90MM
LUG HEIGHT	15MM
<b>CODE</b>	<b>DESCRIPTION</b>
SP-TD-025-FIXED	TD 25MM FIXED HEIGHT TIMBER DECKING PAD WITH 90MM LUGS
SP-TD-035-FIXED	TD 35MM FIXED HEIGHT TIMBER DECKING PAD WITH 90MM LUGS
SP-TD-035	35-50MM TD TIMBER DECKING PAD WITH 90MM LUGS
SP-TD-050	50-70MM TD TIMBER DECKING PAD WITH 90MM LUGS
SP-TD-065	65-100MM TD TIMBER DECKING PAD WITH 90MM LUGS
SP-TD-095	95-130MM TD TIMBER DECKING PAD WITH 90MM LUGS
SP-TD-125	125-160MM TD TIMBER DECKING PAD WITH 90MM LUGS
SP-TD-155	155-190MM TD TIMBER DECKING PAD WITH 90MM LUGS
SP-TD-185	185-220MM TD TIMBER DECKING PAD WITH 90MM LUGS
SP-TD-210	210-245MM TD TIMBER DECKING PAD WITH 90MM LUGS
SP-TD-240	240-275MM TD TIMBER DECKING PAD WITH 90MM LUGS
SP-TD-270	270-305MM TD TIMBER DECKING PAD WITH 90MM LUGS
SP-TD-300	300-335MM TD TIMBER DECKING PAD WITH 90MM LUGS
SP-TD-330	330-365MM TD TIMBER DECKING PAD WITH 90MM LUGS
SP-TD-EXTRA-085	85-135MM EXTRA TD TIMBER DECKING PAD WITH 90MM LUGS
SP-TD-EXTRA-125	125-215MM EXTRA TD TIMBER DECKING PAD WITH 90MM LUGS
SP-TD-EXTRA-210	210-380MM EXTRA TD TIMBER DECKING PAD WITH 90MM LUGS
❶ PLEASE SEE SECTION ON MINI BASES	

## TD PLUS SUPPORT PADS FOR DECKING

A new headpiece for timber decking has been developed, the TD PLUS headpiece. This flat headpiece is square in shape, and has a side bar to one side only. This means larger timber joists can be laid onto the head and details such as junctions between right-angled joists can be adequately supported.



There are two fixing points on the side bar which allow wood screws to be fitted into the timber joist, giving extra stability where required.

## TECHNICAL DATA

MATERIAL	INJECTION MOULDED POLYPROPYLENE
NORMAL WEIGHT TOLERANCE	683KG
MAX LOAD	1171KG
MAX TEMPERATURE	PLUS 75 °C
MIN TEMPERATURE	MINUS 40 °C
BASE PLATE DIAMETER	200MM
HEADPIECE DIMENSION	120 X 90MM
SIDE BAR HEIGHT	30MM
CONNECTING POINTS	2
<b>CODE</b>	<b>DESCRIPTION</b>
SP-TD PLUS-025-FIXED	TD PLUS 25MM FIXED PAD
SP-TD PLUS-035-FIXED	TD PLUS 35MM FIXED PAD
SP-TD PLUS-035	35-50MM TD PLUS TIMBER DECKING PAD
SP-TD PLUS-050	50-70MM TD PLUS TIMBER DECKING PAD
SP-TD PLUS-065	65-100MM TD PLUS TIMBER DECKING PAD
SP-TD PLUS-095	95-130MM TD PLUS TIMBER DECKING PAD
SP-TD PLUS-125	125-160MM TD PLUS TIMBER DECKING PAD
SP-TD PLUS-155	155-190MM TD PLUS TIMBER DECKING PAD
SP-TD PLUS-185	185-220MM TD PLUS TIMBER DECKING PAD
SP-TD PLUS-210	210-245MM TD PLUS TIMBER DECKING PAD
SP-TD PLUS-240	240-275MM TD PLUS TIMBER DECKING PAD
SP-TD PLUS-270	270-305MM TD PLUS TIMBER DECKING PAD
SP-TD PLUS-300	300-335MM TD PLUS TIMBER DECKING PAD
SP-TD PLUS-330	330-365MM TD PLUS TIMBER DECKING PAD
SP-TD PLUS-EXTRA-085	85-135MM EXTRA TD PLUS TIMBER DECKING PAD
SP-TD PLUS-EXTRA-125	125-215MM EXTRA TD PLUS TIMBER DECKING PAD
SP-TD PLUS-EXTRA-210	210-380MM EXTRA TD PLUS TIMBER DECKING PAD

## TD MOBILE PEDESTALS

This movable headpiece is available for decking, which can be adjusted in width so that different sized timber battens and joists can be fitted onto the pads without the risk of the weight being lopsided.

The headpiece comprises of a flat, square shaped plate and a side bar which can be moved to a number of different widths.

The face of the headpiece has clearly defined measurements ranging from 30mm to 90mm, so the side bar can be moved to match the exact width of the timber joist. This ensures that the weight of the timber joist is directed down through the central stem, eliminating the risk of the weight pulling the system off balance and spreading the weight evenly through the base plate.

The side bar clicks into holes situated along the face of the headpiece. These holes are situated so that a 30mm, 50mm, 70mm and 90mm timber joist will sit across the centre of the headpiece, directly on top of the central stem.

The side bar has three holes to allow wood screws to fix the batten / joist to the pedestal, creating a more secure structure.

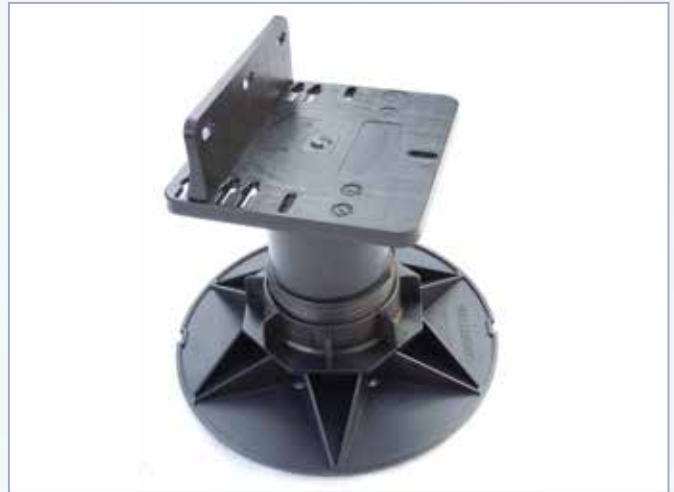

## TECHNICAL DATA

MATERIAL	INJECTION MOULDED POLYPROPYLENE
NORMAL WEIGHT TOLERANCE	683KG
MAX LOAD	1171KG
MAX TEMPERATURE	PLUS 75 °C
MIN TEMPERATURE	MINUS 40 °C
BASE PLATE DIAMETER	200MM
HEADPIECE DIAMETER	120MM X 120MM
SIDE BAR	30MM
CONNECTING POINTS	3
WIDTH OPTIONS	30MM, 50MM, 70MM, 90MM
<b>CODE</b>	<b>DESCRIPTION</b>
SP-TD MOBILE-025-FIXED	TD MOBILE 25MM FIXED PAD
SP-TD MOBILE-035-FIXED	TD MOBILE 35MM FIXED PAD
SP-TD MOBILE-035	35-50MM TD MOBILE TIMBER DECKING PAD
SP-TD MOBILE-050	50-70MM TD MOBILE TIMBER DECKING PAD
SP-TD MOBILE-065	65-100MM TD MOBILE TIMBER DECKING PAD
SP-TD MOBILE-095	95-130MM TD MOBILE TIMBER DECKING PAD
SP-TD MOBILE-125	125-160MM TD MOBILE TIMBER DECKING PAD
SP-TD MOBILE-155	155-190MM TD MOBILE TIMBER DECKING PAD
SP-TD MOBILE-185	185-220MM TD MOBILE TIMBER DECKING PAD
SP-TD MOBILE-210	210-245MM TD MOBILE TIMBER DECKING PAD
SP-TD MOBILE-240	240-275MM TD MOBILE TIMBER DECKING PAD
SP-TD MOBILE-270	270-305MM TD MOBILE TIMBER DECKING PAD
SP-TD MOBILE-300	300-335MM TD MOBILE TIMBER DECKING PAD
SP-TD MOBILE-330	330-365MM TD MOBILE TIMBER DECKING PAD
SP-TD MOBILE-EXTRA-085	85-135MM EXTRA TD MOBILE TIMBER DECKING PAD
SP-TD MOBILE-EXTRA-125	125-215MM EXTRA TD MOBILE TIMBER DECKING PAD
SP-TD MOBILE-EXTRA-210	210-380MM EXTRA TD MOBILE TIMBER DECKING PAD



## TD MEGAPADS

Megapads are available specifically designed for timber decking. TD Megapads have a headpiece with lugs positioned 60mm apart, to house a 2 inch timber joist.



TD Megapads can withstand a load of 1560kg per unit, Normal Weight Tolerance (end of linear behaviour) with a Maximum Load of 2057kg, meaning fewer units are required per square metre. Also, because each unit has a much larger range of adjustment (105mm for the larger sizes), fewer different sizes are required, making estimating an easier task.

The higher weight tolerance means more weight can be placed onto the timber decking. Items such as planters and Jacuzzis can be included, subject to the strength of the actual timber or composite material being sufficient, of course.

As with the paving Megapads, the TD Megapads have a series of telescopic threads laid out on the stems. The units wind up and down on the threads to gain the correct height and the height can be fixed securely with locking rings, which are counter-screwed into place. These rings lock the unit at the height selected. The Megapads will not move on the thread over time, meaning the height of the decking is fixed permanently and there is no risk of rocking.





As the TD Megapads are a more substantial unit, they are sturdy and stable even when fixed to very high levels. The units can be adjusted to a maximum height of 1020mm.

Larger cavities beneath the decking are often sought to give adequate clearance from sections on the sub-deck, such as drainage outlets and pipework. Steps and large changes in the height of the sub-deck can be overlaid easily due to the large height range of the TD Megapads and drainage and water flow is uninterrupted. This improves the ventilation of the system.



### ASSEMBLY (215MM AND HIGHER)

TD Megapads are made up of multiple sections, which lock together to form one, sturdy unit.



At 215mm and higher, TD Megapads are increased in height by adding a 100mm high EXTENSION TOWER.

These towers click into the baseplate and to each other (if required) so multiple towers can be added to the TD Megapad, increasing the height up to a maximum of 1020mm.

A special key is required to unlock the towers once in place. The key can also be used as a wrench to help adjust the height in areas of restricted access.







## TECHNICAL DATA

MATERIAL	INJECTION MOULDED POLYPROPYLENE
NORMAL WEIGHT TOLERANCE	1560KG
MAX LOAD	2057KG
MAX TEMPERATURE	PLUS 75 ° C
MIN TEMPERATURE	MINUS 40 ° C
BASE PLATE DIAMETER	200MM
HEADPIECE DIAMETER	150MM
LUG HEIGHT	15MM
DISTANCE BETWEEN LUGS	60MM
<b>CODE</b>	<b>DESCRIPTION</b>
SP-TD-MEG-010 ①	TD MEGAPAD 10-20MM - SEE MINI MEGAPAD PAGE
SP-TD-MEG-022 ①	TD MEGAPAD 22-30MM - SEE MINI TD MEGAPAD PAGE
SP-TD-MEG-028 ①	TD MEGAPAD 28-37MM - SEE MINI TD MEGAPAD PAGE
SP-TD-MEG-035	TD MEGAPAD 35-50MM
SP-TD-MEG-050	TD MEGAPAD 50-75MM
SP-TD-MEG-075	TD MEGAPAD 75-120MM
SP-TD-MEG-115	TD MEGAPAD 115-220MM
SP-TD-MEG-215	TD MEGAPAD 215-320MM
SP-TD-MEG-315	TD MEGAPAD 315-420MM
SP-TD-MEG-415	TD MEGAPAD 415-520MM
SP-TD-MEG-515	TD MEGAPAD 515-620MM
SP-TD-MEG-615	TD MEGAPAD 615-720MM
SP-TD-MEG-715	TD MEGAPAD 715-820MM
SP-TD-MEG-815	TD MEGAPAD 815-920MM
SP-TD-MEG-915	TD MEGAPAD 915-1020MM
① 683KG WEIGHT TOLERANCE, 150MM BASE - PLEASE SEE MINI MEGAPADS PAGE 30 FOR FULL TECHNICAL DATA	



## FLAT HEADED TD MEGAPADS

If contractors are using very large timber battens, or if timber tiles or plates are being installed; then Flat Headed Megapads can be used. There is no lugged fixing on the head, just a 150mm diameter, completely flat headpiece.



This gives installers another design option and greater flexibility.

Because Megapads tolerate a greater amount of weight – 1560kg per unit Normal Weight Tolerance (end of linear behaviour) with a Maximum Load of 2057kg – a very high load-bearing layer can be constructed. There is more height range available with Megapads, and they often provide a solution for certain complicated areas.



TD Megapads can be set to extremely accurate levels and locked, so the levels are maintained over the long-term. This means decking can be constructed flush up to the door threshold. This creates the seamless “indoors to outdoors” flooring surface which often features in decking areas.

Flat Headed Megapads are also useful for the junction point between timber joists or even other structures completely, such as drainpipes.



They can be used at much larger height, right up to 1020mm, and have been fully tested to tolerate 1560kg per unit Normal Weight Tolerance (end of linear behaviour) with a Maximum Load of 2057kg and remain fully stable. Installations, such as the Jacuzzi pictured above, offer contractors considerable scope to construct a wide variety of schemes.

### TECHNICAL DATA

MATERIAL	INJECTION MOULDED POLYPROPYLENE
NORMAL WEIGHT TOLERANCE	1560KG
MAX LOAD	2057KG
MAX TEMPERATURE	PLUS 75 ° C
MIN TEMPERATURE	MINUS 40 ° C
BASE PLATE DIAMETER	200MM
HEADPIECE DIAMETER	150MM
<b>CODE</b>	<b>DESCRIPTION</b>
SP-TD-MEG-STEM-010 ①	FLAT HEADED MEGAPAD 10-20MM - SEE MINI FLAT HEADED MEGAPAD PAGE
SP-TD-MEG-STEM-022 ①	FLAT HEADED MEGAPAD 22-30MM - SEE MINI FLAT HEADED MEGAPAD PAGE
SP-TD-MEG-STEM-028 ①	FLAT HEADED MEGAPAD 28-37MM - SEE MINI FLAT HEADED MEGAPAD PAGE
SP-TD-MEG-STEM-035	FLAT HEADED MEGAPAD 35-50MM
SP-TD-MEG-STEM-050	FLAT HEADED MEGAPAD 50-75MM
SP-TD-MEG-STEM-075	FLAT HEADED MEGAPAD 75-120MM
SP-TD-MEG-STEM-115	FLAT HEADED MEGAPAD 115-220MM
SP-TD-MEG-STEM-215	FLAT HEADED MEGAPAD 215-320MM
SP-TD-MEG-STEM-315	FLAT HEADED MEGAPAD 315-420MM
SP-TD-MEG-STEM-415	FLAT HEADED MEGAPAD 415-520MM
SP-TD-MEG-STEM-515	FLAT HEADED MEGAPAD 515-620MM
SP-TD-STEM-615	FLAT HEADED MEGAPAD 615-720MM
SP-TD-STEM-715	FLAT HEADED MEGAPAD 715-820MM
SP-TD-STEM-815	FLAT HEADED MEGAPAD 815-920MM
SP-TD-STEM-915	FLAT HEADED MEGAPAD 915-1020MM
① 683KG WEIGHT TOLERANCE, 150MM BASE - PLEASE SEE MINI MEGAPADS PAGE 30 FOR FULL TECHNICAL DATA	



## TD PLUS MEGAPAD

A new style of headpiece is available for the TD Megapad, where installers wish to fix the timber joist to the pad unit. This may be desired if users wish to ensure there is no movement of the timber, or perhaps if a much larger joist is placed onto the pad.



The TD PLUS Megapad is priced at the same level (at the equivalent height), and contains the same technical strength properties, of the TD Megapad.

## TECHNICAL DATA

MATERIAL	INJECTION MOULDED POLYPROPYLENE
NORMAL WEIGHT TOLERANCE	1560KG
MAX LOAD	2057KG
MAX TEMPERATURE	PLUS 75 °C
MIN TEMPERATURE	MINUS 40 °C
BASE PLATE DIAMETER	200MM
HEADPIECE DIAMETER	150MM
LUG HEIGHT	30MM
FIXING POINTS	2
<b>CODE</b>	<b>DESCRIPTION / SIZE</b>
CODE	DESCRIPTION / SIZE
SP-TDPLUS-MEG-010 ①	TD PLUS MEGAPAD 10-20MM - SEE MINI MEGAPAD PAGE
SP-TDPLUS-MEG-022 ①	TD PLUS MEGAPAD 22-30MM - SEE MINI MEGAPAD PAGE
SP-TDPLUS-MEG-028 ①	TD PLUS MEGAPAD 28-37MM - SEE MINI MEGAPAD PAGE
SP-TDPLUS-MEG-035	TD PLUS MEGAPAD 35-50MM
SP-TDPLUS-MEG-050	TD PLUS MEGAPAD 50-75MM
SP-TDPLUS-MEG-075	TD PLUS MEGAPAD 75-120MM
SP-TDPLUS-MEG-115	TD PLUS MEGAPAD 115-220MM
SP-TDPLUS-MEG-215	TD PLUS MEGAPAD 215-320MM
SP-TDPLUS-MEG-315	TD PLUS MEGAPAD 315-420MM
SP-TDPLUS-MEG-415-	TD PLUS MEGAPAD 415-520MM
SP-TDPLUS-MEG-515	TD PLUS MEGAPAD 515-620MM
SP-TDPLUS-MEG-615	TD PLUS MEGAPAD 615-720MM
SP-TDPLUS-MEG-715	TD PLUS MEGAPAD 715-820MM
SP-TDPLUS-MEG-815	TD PLUS MEGAPAD 815-920MM
SP-TDPLUS-MEG-915	TD PLUS MEGAPAD 915-1020MM
① 683KG WEIGHT TOLERANCE, 150MM BASE - PLEASE SEE MINI TD MEGAPADS PAGE 30 FOR FULL TECHNICAL DATA	



## SHOCK ABSORBING SHIMS

Timber decked areas can often become noisy to walk across, especially if the deck is above residential dwellings. The Wallbarn PVC acoustic shim can also be used with TD pedestals to help insulate sound and vibration.

The shim is designed to fit both ASP and TD pedestals, and will hook over the positioning lugs (which are spaced out 60mm and 40mm apart on the headpiece) and sits securely in place.

The timber joist will sit on the rubber shim, giving extra grip and helping to deaden the sound and vibration.



## TECHNICAL DATA

2.5MM SHOCK ABSORBING SHIM	
CODE	SP-RUB-0025
MATERIAL	PVC
THICKNESS / HEIGHT OFF SURFACE	2.5MM
WEIGHT TOLERANCE / BEARING CAPACITY	8,000KG
OUTER DIAMETER	150MM

## FLAT HEADED ADJUSTABLE SUPPORTS

Where installers are laying extremely large timber joists, or for areas where a junction of joists occurs, flat headed adjustable pedestals can be used for decking. These units come in the same heights as the TD Supports.



The diameter of the headpiece is 120mm, so a wider joist can sit onto it easily. Provided that the joists are cross fixed regularly, the frame created will become strong, sturdy and secure.

They can prove a useful addition to decking systems and many designers prefer using these flat headed units to other varieties. They are priced at the same rate as TD supports at the corresponding height.



Flat headed support pads have also been used successfully to hold up modular timber buildings, site buildings, sheds and portakabins. Plate materials, such as large plywood bases, even metal grates and gangway structures can be placed onto these adjustable height support pads to make them level.

It is often far better to crane large, heavy temporary buildings onto these supports, where the level has been pre-set to be flat, than to have personnel underneath trying to adjust those levels whilst the structure is being suspended.

These units hold a weight of 683kg per unit Normal Weight Tolerance (end of linear behaviour) with a Maximum Load of 1171kg, so a calculation of how many units are required to hold the structure must be made beforehand.



Flat Headed Pedestals can be used with larger timber joists or the aluminium rails available as part of iDecking EasyClick system, available exclusively through Wallbarn.



## TECHNICAL DATA

MATERIAL	INJECTION MOULDED POLYPROPYLENE
NORMAL WEIGHT TOLERANCE	683KG
MAX LOAD	1171KG
MAX TEMPERATURE	PLUS 75 °C
MIN TEMPERATURE	MINUS 40 °C
BASE PLATE DIAMETER	200MM
HEADPIECE DIAMETER	120MM
<b>CODE</b>	<b>DESCRIPTION</b>
SP-FLAT-025-FIXED	FLAT HEADED 25MM FIXED PAD
SP-FLAT-035-FIXED	FLAT HEADED 35MM FIXED PAD
SP-FLAT-035	35-50MM FLAT HEADED ADJUSTABLE SUPPORT PAD
SP-FLAT-050	50-70MM FLAT HEADED ADJUSTABLE SUPPORT PAD
SP-FLAT-065	65-100MM FLAT HEADED ADJUSTABLE SUPPORT PAD
SP-FLAT-095	95-130MM FLAT HEADED ADJUSTABLE SUPPORT PAD
SP-FLAT-125	125-160MM FLAT HEADED ADJUSTABLE SUPPORT PAD
SP-FLAT-155	155-190MM FLAT HEADED ADJUSTABLE SUPPORT PAD
SP-FLAT-185	185-220MM FLAT HEADED ADJUSTABLE SUPPORT PAD
SP-FLAT-210	210-245MM FLAT HEADED ADJUSTABLE SUPPORT PAD
SP-FLAT-240	240-275MM FLAT HEADED ADJUSTABLE SUPPORT PAD
SP-FLAT-270	270-305MM FLAT HEADED ADJUSTABLE SUPPORT PAD
SP-FLAT-300	300-335MM FLAT HEADED ADJUSTABLE SUPPORT PAD
SP-FLAT-330	330-365MM FLAT HEADED ADJUSTABLE SUPPORT PAD
SP-FLAT-EXTRA-085-Z	85-135MM EXTRA FLAT HEADED ADJUSTABLE SUPPORT PAD
SP-FLAT-EXTRA-125-Z	125-215MM EXTRA FLAT HEADED ADJUSTABLE SUPPORT PAD
SP-FLAT-EXTRA-210-Z	210-380MM EXTRA FLAT HEADED ADJUSTABLE SUPPORT PAD



## SLOPE CORRECTORS FOR TD, TD PLUS, TD MOBILE & TD MEGAPAD PEDESTALS

Slope correctors are wedge shaped plastic levellers which are clipped or fitted onto the base plate of adjustable pedestals. They are suitable for use with TD and TD Megapad supports; including the new mini-Megapads and the TD EXTRA range.

Slope correctors are available in three sizes, with a 1%, 2% and 3% gradient.



They are designed to arrest the fall of the roof or deck which will be built to a fall for drainage. By having these wedges attached underneath, the support pads remain completely vertical and straight, which ensures the force of gravity runs directly vertical (see purple arrows below), preventing tilting and keeping the support pad more stable.

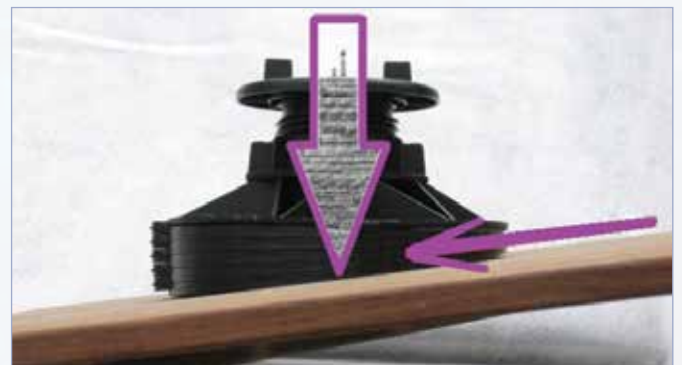
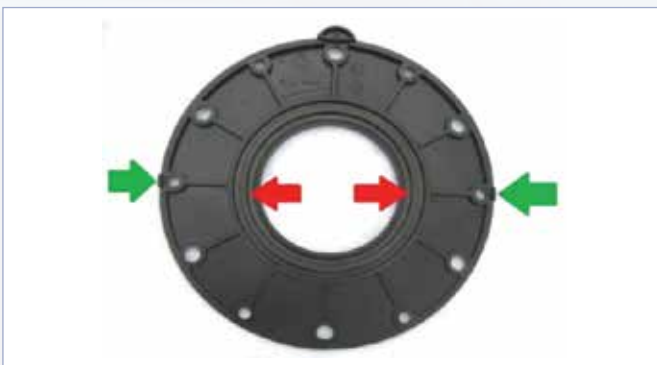

They are very easy to apply to the base plate. For the 200mm diameter base plates, two simple clips (green arrows) fix around the lip of the baseplate. All 150mm base plates have a groove inside the perimeter which slots into a series of ridges (red arrows) situated on the inner ring of the slope corrector.

More than one slope corrector can be applied if required as one can clip onto another very easily. Wallbarn recommends that pedestals are used on roof decks with a maximum slope of 10%.

The gradient or slope is measured as a percentage. The deck is most commonly laid to a fall around 1 in 40, so a 2% slope corrector is normally chosen.

### TECHNICAL DATA

MATERIAL	INJECTION MOULDED POLYPROPYLENE	
MAX TEMPERATURE	MOBILE 75 °C	
MIN TEMPERATURE	MINUS 40 °C	
OUTER DIAMETER	200MM	
INNER DIAMETER	82MM	
CODE	DESCRIPTION	
SP-ASP-SLOPE001	1 PERCENT SLOPE CORRECTOR	ASP, ASP EXTRA, MEGAPAD, MINIPAD TD, TD PLUS, TD MOBILE, TD EXTRA, TD MEGAPAD, TD MINIPAD
SP-ASP-SLOPE002	2 PERCENT SLOPE CORRECTOR	
SP-ASP-SLOPE003	3 PERCENT SLOPE CORRECTOR	

## EDGING & CREATING STEPS

### METAL PLATES FOR CREATING STEPS ON DECKING

Metal clips can be used as a useful tool for terminations and steps in decking projects. If users wish to install a vertical piece of timber to the area these brackets can fix the timber to the baseplate at the bottom and hold it in place at the point where it meets the deck boards on the horizontal plane.



METAL CLIP FOR ABOVE JOIST – CLIP A

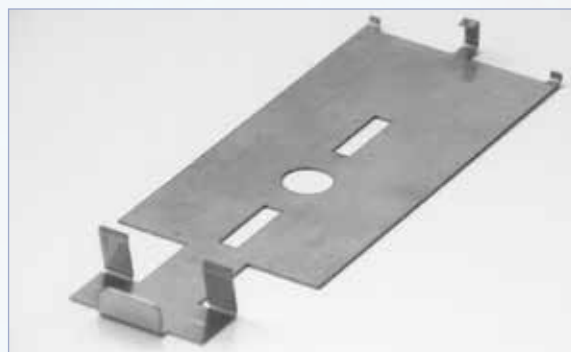

METAL CLIP FOR UNDER BASEPLATE – CLIP B

The baseplate of the pedestal needs to be cut back slightly to accommodate the spring-loaded fasteners at the front of the baseplate clip (CLIP B). At the back of this clip there are three grips which will hold the baseplate securely.

The vertical board / fascia should be installed at this point. The vertical braces at the bottom of the system are 20mm apart but spring loaded to a certain degree, so there is a little bit of room to fit the board if it is not the exact same thickness (installers will need to trim the board if the thickness is significantly different, of course).

Once the fascia is in place the top plate (CLIP A) should be fitted.

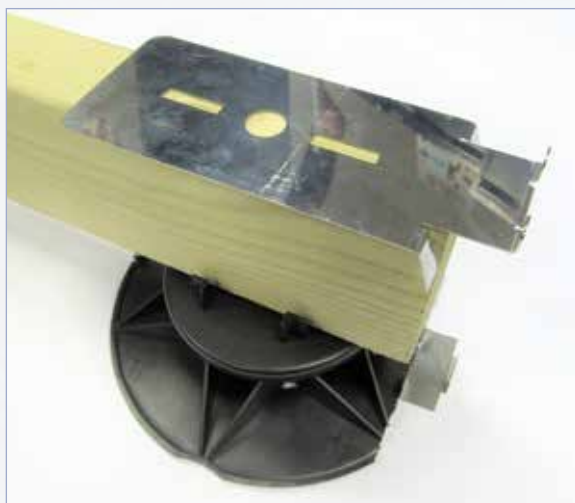

The upper clip (CLIP A) is rested onto the timber joist and screwed into place to make it securely fitted to that joist. There are grips pointing upwards and downwards on this upper clip. The downwards pointing grips will hold the vertical fascia board in place and the upwards pointing grips will brace the horizontal deck board.

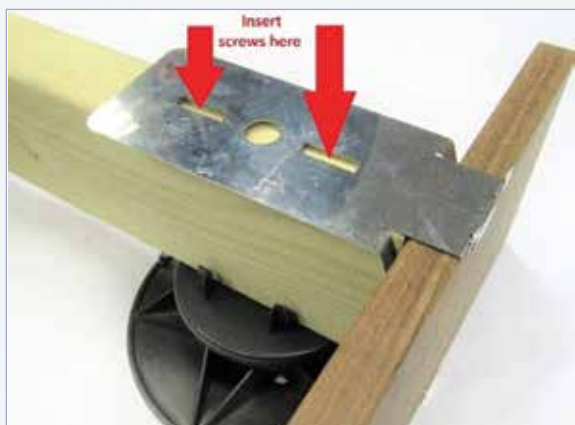

The deckboard should then be mechanically fixed to the timber joist in the normal way. The small upwards pointing grips will show at the edge but the design is stylish and the finish is very attractive.



If installers wish to fit decking so that the edge of the deck board is not shown, they can do so using just CLIP B.

CLIP B is fitted under the baseplate in the same way but the fascia / vertical board will be laid up to the level of the timber joist. The fascia / vertical board is also mechanically fixed to the joist with a counter sunk screw (and dowel, if required).



The deck board will be mechanically fixed to the timber joist in the normal way, either via hidden fixings or vertical screws, and will match up to the level of the fascia / vertical board in a tidy finish.

**Using these metal clips is not a substitute for fitting a proper, structural termination section. These clips will hold fascia boards and vertical sections in place but the strength of these fixings is limited, so Wallbarn would recommend a structural section set into the slab to hold the decking in place if considerable traffic onto steps and termination details is anticipated.**

### **FIXING PEDESTALS IF REQUIRED**

If a moderate level of traffic on these step details is anticipated, to hold the pedestals more securely, a suggestion is to bond the pedestals, be that TD Supports or TD Megapads, to the subdeck. This will make the decking or paving stable and secure at this exposed edge and prevent the pedestals and decking moving over time.



The best option is to use TD Megapads which have holes around the circumference where a mechanical fixing and / or adhesive can be set through the holes to ensure the unit does not move over time.

**Ask Wallbarn for more details of the new edging clips.**





## TIMBER & DECKING PRODUCTS

Wallbarn supplies a number of timber and decking products. These include a range of tropical hardwood tiles in a variety of profiles, styles and sizes; composite and timber decking; and the award winning iDecking Revolution decking design, featuring EasyClick and EasyChange fixing systems and the innovative Duro Excellence composite decking material. We focus on top quality, durable, long lasting decking materials.



Wallbarn has a number of different options for clients wishing to install decking systems. If access to the roof is a problem or if height thresholds are an issue, timber tiles can be considered. For larger areas and projects where cladding and parapet walls need to be decked out, iDecking is the perfect choice. For a greater variety of shades, textures and colours, our range of different tropical hardwood species are available. For FSC® certified timber and the latest developments in eco-friendly composite materials, Wallbarn is the obvious choice.



In addition to timber tiles and decking systems, Wallbarn has a range of high quality timber care and maintenance products for both timber and composite material. These liquids have been formulated to enhance the decking material and extend its lifespan. We also have access to extensive design resources and other related products to aid with landscaping schemes.

Wallbarn always strives to source timber from ethical and sustainable sources and has achieved Forest Stewardship Council® Chain of Custody certification. Wallbarn is therefore certified to supply FSC certified timber.

**FSC® 100% Chain of Custody certified timber – number SGS-COC-007242.**

The FSC® scheme means that the certified timber can be traced back to well-managed forests in accordance with the rules of The Forest Stewardship Council®.





## TROPICAL HARDWOOD TIMBER DECKING TILES

Wallbarn supplies a range of hardwood timber manufactured in tile form. These easy to install tiles mean that natural, beautiful tropical hardwood can be laid onto roofs, terraces and balconies in a similar manner to paving slabs. The timber is suspended on ASP pedestals without the need for mechanical fixings.



By using suspended hardwood decking tiles, installers can combine the natural, attractive finish of wood with the ease and speed of laying paving slabs. Installers avoid the need to lay joist frames and drill planks into place. Unlike traditional long-plank decking systems, specialist carpentry skills are not required. It is a matter of ensuring the levels are correct and resting the tiles in place.

Another major advantage over long-plank decking is the size of the tiles. They measure 500 x 500 x 30mm and are easy to transport and handle on site.

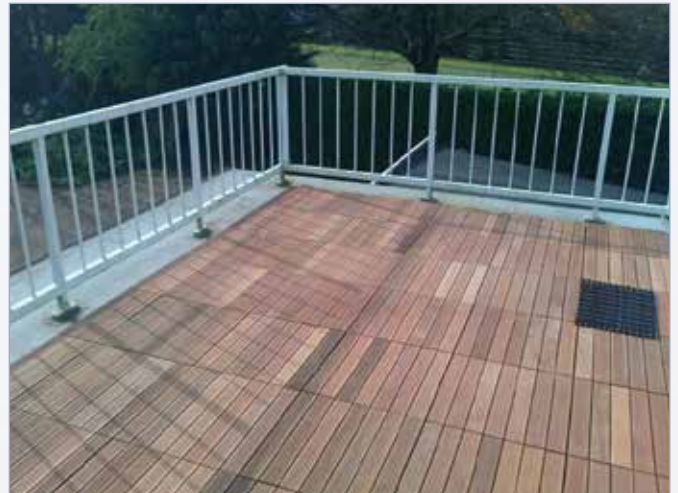

As long as the terrace area is surrounded by a parapet around the perimeter, the timber will remain securely in place. The tiles do not come into direct contact with the surface beneath, meaning waterproofing membranes are not compromised therefore, reducing the risk of damage, and improving rainwater drainage as outlets are fully accessible.

Wallbarn offers only the best quality hardwood timber. The species chosen are ultra-hard and dense, in order to repel moisture and rotting and to cope with the British climate in the long term. They have smooth grains which are unlikely to splinter or scratch on the surface and are resistant to insect and mildew damage. These tiles are extremely strong and weight bearing.



Wallbarn tropical hardwood timber tiles are ideal for use on areas where only a low height threshold is available. Because a structural joist is not required, decking areas with very tight height restrictions are now possible.

The tiles are installed in conjunction with Wallbarn ASP, Megapad or fixed height pedestals / support pads.



The tiles are suspended on the supports in the same way as a paving slab. The weight of the tiles holds the system in place. The crucifix shaped positioning lugs hold the square edges securely in place. The corners of four tiles will sit onto each pad and the lugs give a clear separation between each tile and ensure uniform and straight alignment.



The tiles can be installed with all “deckboards” running in the same direction, or in the “chess board” formation. Both styles are equally effective and are purely a matter of design.

The major advantage of this system is that if the deck beneath ever needs to be inspected, a tile can be easily lifted up.

Unightly objects such as roof drain outlets, pipework and services can be covered and accessed at any time. Beautiful finishes can be achieved with the minimum of disruption and labour.

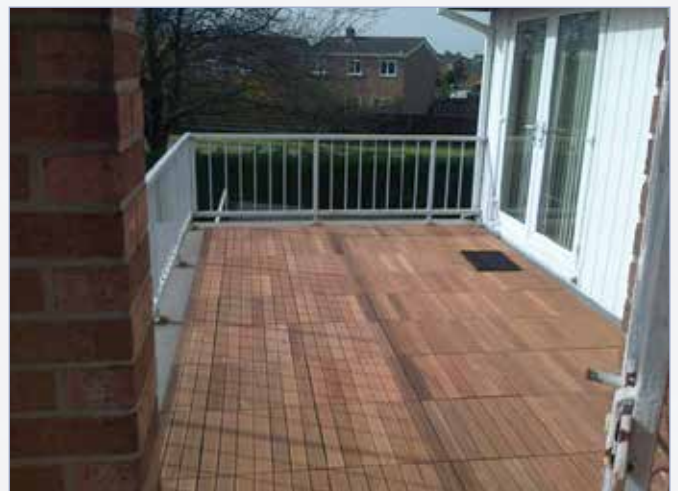

## TYPE OF TIMBER AVAILABLE

All timber used in Wallbarn tropical hardwood timber tiles has been selected to withstand long-term exposure to the UK climate. They are resistant to decay and water ingress and provide a superior, permanent wood finish on exterior decks.

Wallbarn stocks timber tiles made from **Ipè** (Lapacho), **Cumaru** (Dipteryx Odorata) and **Garapa** (Apuleia Leiocarpa) as standard. Other species, such as Thermo Ash, Massaranduba and Green Heart are also available as non-standard items.

### IPÈ

Ipè wood from Brazil is one of the toughest most durable woods available. It ranges in colour from a dark brown to olive green and pale brown appearance. The colour can differ even on an individual tile. It is also known as Lapacho or Brazilian Walnut. Its botanical name is *Tabebuia* spp, from the family Bignoniaceae.

It is very low maintenance and is ideal for decking schemes in private residential, commercial and public areas alike. The wood is used extensively in marine and cladding areas due to its resistance to water. Because it has such a tight grain it is recognised for its high resistance to mildew, termites and rotting. It dries very well and becomes extremely hard, which means it has to be pre-drilled and cut with a mechanical saw.

It carries a Class A fire rating and will last well over 25 years. It is nicknamed “ironwood”.

When exposed to sunlight and long-term adverse weather conditions, the wood undergoes a natural tone and colour alteration and will change in colour to a silvery grey. Treating the wood at least once per year with natural oils is recommended to help enhance the original colour.

### CUMARU

Cumaru is also known for its exceptional hardness and durability. It is also known as Brazilian Teak, Almendrillo, Champanha, Tonka or Southern Chestnut. Its botanical name is *Dipteryx Odorata*, from the family Fabaceae.

This dense wood has a range of colours varying from a tan brown to a reddish brown with some pieces offering a black or purplish striping. Unlike most exotic hardwood, cumaru undergoes very little colour change due to UV light. The colour will tend to fade rather than change drastically, becoming a more uniform colour over time.

This exotic hardwood is a great choice in both residential and commercial installations, especially to users who prefer a more brownish look to their application.

### GARAPA

Garapa is also known as Brazilian Ash, Grapia, Amarealao, Marotoa, Muiratua or Muirajuba. Its botanical name is *Apuleia Leiocarpa* from the family Caesalpiniceae.

It is a quality hardwood with a light yellow to golden honey colour and a fine grain. It is an excellent alternative for those who want a lighter coloured hardwood for a decking scheme. It is naturally resistant to rotting, decay and insect attack. The colour will fade over time to a greyish silvery colour. It is a little easier to cut and drill than cumaru and ipe and tools will last longer.

Regular cleaning and maintenance with appropriate detergents and oils will keep all tropical hardwood in the best condition.



The mark of  
responsible forestry

### FSC® CERTIFIED TIMBER

Wallbarn has Forest Stewardship Council® Chain of Custody certification.

The FSC® scheme means that the certified timber can be traced back to well-managed forests in accordance with the rules of the Forest Stewardship Council®.

Every party, from the grower to the processor to the manufacturer of the tiles to the end user is tracked and audited to ensure that they have complied with the ethical and well managed forest practices laid down by the FSC®. The whole chain is monitored.

**FSC® 100% Chain of Custody certified timber – number SGS-COC-007242.**

Only fully certified companies within the Chain of Custody can use the official FSC® logo against FSC® certified timber. FSC® credited timber is clearly distinguished and marked as separate from non-FSC timber and the mark can only be used with FSC® material.

Please contact us for full details of compliance to FSC® Chain of Custody and more information on the scheme.



## DETAILING

All the tiles are manufactured with seven boards / planks running in one direction. The boards have a series of small ridges / castles on the upper side to aid grip.

They are reinforced underside with an additional board /plank fixed at each end and a diagonal cross beam to provide extra strength and durability. All the boards are fixed together with rust-resistant screws.



The timber decking tiles can be cut into shapes to fit around awkward areas, edges and details without becoming unstable, due to the reinforced underside. The grain is smooth and uniform in most cases, so sawing and drilling is possible. It is essential that installers ensure that pedestals are situated under all cuts, edges and corners in order to sufficiently support the tiles.



Because the timber is so dense and strong Wallbarn recommends that carbide tipped saw blades are used when cutting the tiles. Saw blades will become blunt very quickly when working these types of timber. To avoid the wood splitting, Wallbarn recommends pre-drilling all fixing holes before screwing into the wood.



Borders and profile pieces made from the same timber species are available and can be fitted to the edges of the tiles to help give termination and a more attractive finish.

Wallbarn hardwood timber tiles are the easiest, most cost effective way of installing top quality tropical hardwood decking on rooftops and terraces.



## LANDSCAPING OPTIONS USING TIMBER TILES

These timber tiles can be used in conjunction with other landscaping materials to create highly creative and natural spaces on rooftops and podium decks. With the push to add nature to high density areas and also to utilise the building footprint more, roof gardens can be constructed with the minimum of disruption using these timber tiles, mounted onto Wallbarn pedestals.



The height threshold can easily be set to the level of the green roof so that the decking area is flush to the level of the vegetation. By not having the added height of the timber joists, these hard-and-soft rooftop schemes are achievable in more instances.

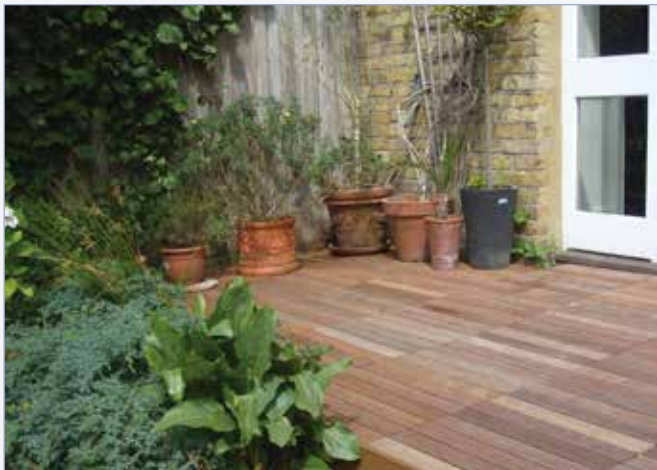

Refurbishment works are also more possible with the lower height thresholds since pre-existing elements such as handrails or damp-proof courses can be accommodated more easily without the need for alteration.



Using hardwood timber tiles and adjustable supports is a far easier way to achieve the correct level on terraces. They will reduce costs and labour time considerably and will avoid the need for constant cutting of timber joists and re-measuring.

## TECHNICAL DATA

RAW MATERIAL	IPE	CUMARU	GARAPA
BOTANICAL NAME	LAPACHO, TABEBUIA SPP	DIPTERYX ODDORATA	APULEIA LEIOCARPA
DENSITY (GREEN)	960KG/M3	910KG/M3	670KG/M3
DENSITY (DRY)	994KG/M3	1,138KG/M3	830KG/M3
JANKA HARDNESS	3684	3540	1631
BENDING STRENGTH (GREEN)	1,579KG/M2	1,357KG/M2	956KG/M2
BENDING STRENGTH (DRY)	1,825KG/M2	1,917KG/M2	1,278KG/M2
CRUSHING STRENGTH (GREEN)	1,825KG/M2	1,917KG/M2	380KG/M2
CRUSHING STRENGTH (DRY)	725KG/M2	634KG/M2	554KG/M2
SPECIFIC GRAVITY (GREEN)	0.92	0.86	
SPECIFIC GRAVITY (DRY)	1.08	0.9	0.66
HARDNESS	1,671 KG	1,606KG	740KG
SHEARING STRENGTH	114KG/M2	KG/M2	129KG/M2
WEIGHT	994KG/M3	1,138KG/M3	835KG/M3
RADIAL SHRINKAGE	6.6%	5%	4.4%
TANGENTIAL SHRINKAGE	8%	7.6%	8.5%
VOLUMETRIC SHRINKAGE	13.2%	12%	14%
COLOUR	DARK GREEN TO OLIVE GREEN TO DARK BROWN TO MID-BROWN	CHESTNUT / DARK HONEY COLOUR TO REDDISH BROWN	YELLOWISH BEIGE TO YELLOWISH BROWN
TEXTURE	FINE, TIGHT GRAIN	UNSTRESSED FIBROUS	FINE, SMOOTH GRAIN
DURABILITY	VERY HARD, RESISTANT TO TERMITES, FUNGUS, MARINE ATTACK AND DAMP	RESISTANT TO FUNGAL AND MARINE ATTACK, HIGH RESISTANCE TO DECAY	RESISTANT TO TERMITES, MARINE ATTACK, FUNGI AND DECAY
LIFESPAN	25 YEARS	20 YEARS	UP TO 15 YEARS
SIZE OF TILE	500 X 500MM	500 X 500MM	500 X 500MM
THICKNESS OF TILE	30MM	30MM	30MM
WEIGHT OF TILE	6KG	5KG	4KG
SAWING CHARACTERISTICS	REGULAR SAWING BUT BLUNTS MACHINERY QUICKLY DUE TO EXTREME HARDNESS – CARBIDE TIPPED BLADES RECOMMENDED	DIFFICULT. SPLITS DUE TO IRREGULAR GRAIN	RELATIVELY EASY TO CUT
DRILLING CHARACTERISTICS	EASY BUT BLUNTS MACHINERY QUICKLY DUE TO EXTREME HARDNESS	EASY BUT WITH DEFECTS. HIGH QUALITY DRILL BITS RECOMMENDED	EASY BUT WITH DEFECTS. HIGH QUALITY DRILL BITS RECOMMENDED
PRE-DRILL SCREW HOLES?	YES	YES	YES
FINISHING CHARACTERISTICS	GOOD - SMOOTH	GOOD WITH MINOR DEFECTS	GOOD - SMOOTH
DRYING CHARACTERISTICS	EASY WITH LITTLE OR NO DEFECTS	EASY BUT WITH DEFECTS	EASY WITH LITTLE OR NO DEFECTS
FIRE RATING	CLASS A	CLASS A	CLASS A

	IPE	CUMARU	
SLIP TEST - BS7976-2 PENDULUM SLIP TEST	DRY PRINCIPAL (DIRECTION)	64	58
	DRY 45 DEGREES	59	55
	RESULT:	61.5 LOW RISK	56.5 LOW RISK
	WET PRINCIPAL	33	25
	WET 45 DEGREES	34	31
RESULT:	33.5 MODERATE RISK	28 MODERATE RISK	



## “MODULO” FSC® 100% PLANTATION TEAK DECKING TILES

Wallbarn also offers larger timber tiles made from FSC® 100% Plantation Teak. These products create a different appearance and feel to the smaller tiles featured earlier, and being teak, the colour and grain is also different; so more options are available to designers and end clients on landscaping areas.

As with the smaller tiles, using timber tiles, as opposed to long-plank decking systems, avoids many of the time consuming and complicated aspects to constructing timber decks.



Larger than the timber tiles featured earlier, these teak tiles have a specially designed fixing mechanism, which means they connect together easily to form a more seamless, continuous deck finish. The quality of the timber also creates the most luxurious, beautiful appearance.



The tiles are pre-formed in the factory so many of the fixings have already been made. They have a special interlocking mechanism on the edge of each tile, so that they slot together to form a continuous decking layer. Fixings and cuts are drastically reduced as the assembly has been carried out off-site.

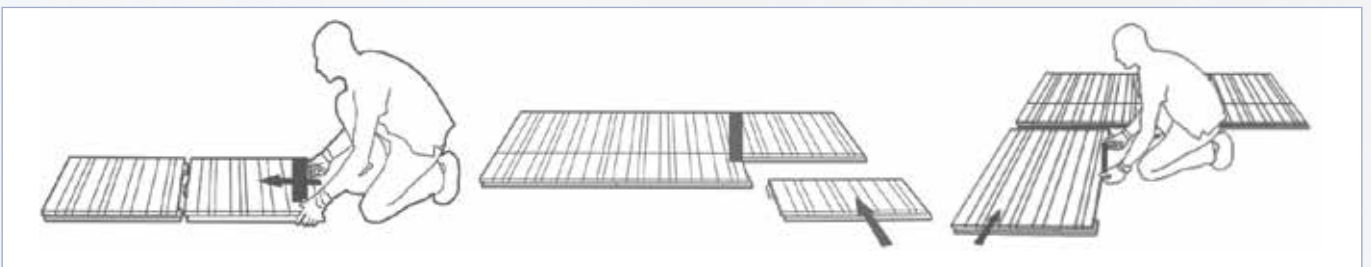

This easy-to-install range of decking makes it an extremely fast, easy and hassle-free way to install high quality tropical hardwood decking. It offers functionality, aesthetic versatility and durability.



## STYLES

### BARCODE

This style is assembled with different plank thicknesses which gives a varied "Barcode" appearance.

A pack contains three different sized tiles:

714 x 300 x 40mm

714 x 600 x 40mm

714 x 900 x 40mm



### FENCE STYLE

Each plank on the tile is the same width and length and all have rounded edges. It to give a more uniform look.

There is one tile size:

842 x 1,100 x 40mm.



### NAVY STYLE

The planks are of different thicknesses on the tile in a similar way to the barcode style. In addition, there is a perpendicular border plank at one end which acts as a border edge.

There is one tile size: 854 x 664 x 40mm

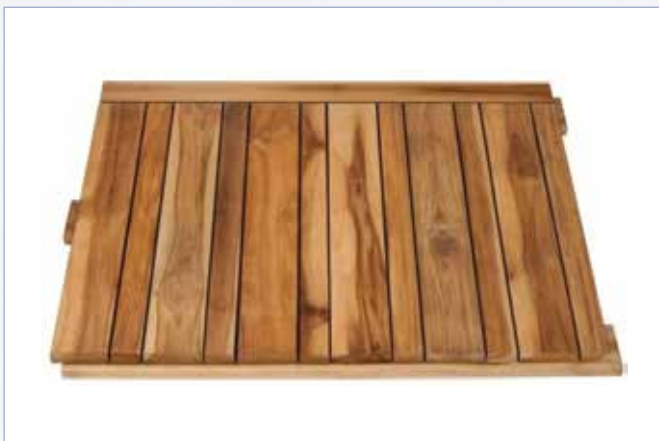

## TIMBER SPECIES

The tiles are manufactured from Thermo Plantation Teak. All the timber is sourced from approved plantations so the harvesting process is fully sustainable. The steam treatment process gives the timber additional strength and moisture resistance properties, making it longer lasting and stronger.

## THE STEAMING THERMIC PROCESS

The tiles are manufactured using FSC® Plantation Teak. This material has been treated with a special steaming thermic process. After this treatment, the Teak takes on a burnished yellow colour, which gives higher resistance to the elements when compared to traditional plantation Teak. It also improves the aesthetic appearance.

When exposed to UV sunlight and adverse weather conditions, the teak wood will fade in colour over time and tend to turn grey. Regular maintenance with approved cleaning solutions and natural oil can minimise this effect and help to restore the original natural colour.



The mark of responsible forestry

## FSC® CERTIFIED TIMBER

All the Teak used in the manufacture of these tiles is sourced from plantation forests in Brazil and for these tiles we use only FSC® 100% certified timber, under guidelines laid out by the Forest Stewardship Council®.

The FSC® scheme means that the certified timber can be traced back to well-managed forests in accordance with the rules of the Forest Stewardship Council®. This means we support the management of the sustainable plantations, helping to promote and respect the environment and local workers, without damaging precious tropical forests.

Every party, from the grower to the processor to the manufacturer of the tiles to the end user is tracked and audited to ensure that they have complied with the ethical and well managed forest practices laid down by

the FSC®. The whole chain is monitored.

## FSC® 100% Chain of Custody certified timber – number SGS-COC-007242.

Only fully certified companies within the Chain of Custody can use the official FSC® logo against FSC® certified timber. FSC® credited timber is clearly distinguished and marked as separate from non-FSC timber and the mark can only be used with FSC® material.

Please contact us for full details of compliance to FSC® Chain of Custody and more information on the scheme.

## TECHNICAL DATA

PHYSICAL PROPERTIES	VALUES	STANDARD DEVIATION
SPECIFIC GRAVITY	600 KG/M <sup>3</sup>	± 50 KG/M <sup>3</sup>
MONNIN HARDNESS	5.15	± 0.05
VOLUMETRIC SHRINKAGE COEFFICIENT	6.9 %	± 0.5 %
TANGENTIAL SHRINKAGE COEFFICIENT	4.4 %	± 0.5 %
RADIAL SHRINKAGE COEFFICIENT	2.3 %	± 0.1 %
TANGENTIAL SHRINKAGE COEFF./ RADIAL SHRINKAGE COEFF. RATIO	1.9 %	/
FIBRE SATURATION POINT	23%	/
STABILITY	STABLE	/
<b>MECHANICAL PROPERTIES</b>		
CRUSHING STRENGTH	41 MPA	± 6 MPA
STATIC BENDING STRENGTH	95 MPA	± 10 MPA
MODULUS OF ELASTICITY	10,000 MPA	± 700
<b>NATURAL DURABILITY</b>		
FUNGI (ACCORDING TO E.N. STANDARDS)	CLASS 3: MODERATELY DURABLE	
DRY WOOD BORERS	DURABLE	
TERMITES (ACCORDING TO E.N. STANDARDS)-	CLASS M: MODERATELY DURABLE	
USE CLASS ENSURED BY NATURAL DURABILITY	3	
SPECIES COVERING THE USE CLASS 5	NO	



The mark of responsible forestry

Source: ASTM D 143-94 (2000) Standard Methods of testing Small Clear Specimens of Timber Cirad – the French Research Centre which monitors agricultural & sustainable developments – [www.cirad.tropix.fr](http://www.cirad.tropix.fr)

All timber FSC® 100% Plantation Teak – Chain of Custody certified timber – number SGS-COC-007242.



# iDecking

REVOLUTION

iDecking is the new revolutionary way to install high quality composite and tropical hardwood decking. It has been developed for speed and ease of installation, sustainability and the most luxurious of finishes and appearance. It can be used on areas where very low height thresholds are necessary, making this system much more flexible than traditional decking systems.



There are two options available: EasyClick and EasyChange. These patented designs mean that no fixings or screws are visible; the boards are fixed from beneath. Fixing is easy, fast and hassle free. The iDecking systems are supplied as a kit, with everything pre-measured and pre-set. It is almost impossible to go wrong.



EasyClick



EasyChange

Installation could not be easier. Everything the installer requires has been fabricated off-site. All installers need to do is assemble the components. No screws, no drilling and no fixing of clips are required.



Just click the boards into place.



## EASYCLICK

EasyClick is the ingenious new way to install top quality decking on flat roofs, balconies and walkways. The most luxurious, blemish-free DURO Excellence composite and hard wood timber is fitted up to five times faster than traditional methods.



The underside of the deckboards have been pre-grooved, so each board clicks into the bracket beneath, just stamp on the board and it clicks into place. The fact that installers do not need to secure fixings into each board is a major labour advantage. The battens beneath are made from aluminium, so are very strong and weight bearing whilst being thinner than traditional treated softwood joists.



The aluminium battens on the EasyClick system have been fitted with nylon clips in the factory. These clips have been pre-measured and fixed to the batten to the exact spacing for the deck boards. The grooves on the edges and underside of the deck boards are set to click into the dart-shaped clips underneath. Installers do not need to measure the gaps between each deck board and no fixings are required between them.

Once the deck boards are connected into the dart shaped clips (different species of timber have different deck widths, so the clips will be laid out at different spacings) they are secured and cannot move out of position. The deck boards can only be fitted exactly perpendicular to those battens. It is impossible to fix decking which is not completely straight and uniform using this system.



The overall thickness of the EasyClick system, including batten, clips and deckboards, is 52mm. Unlike traditional decking systems, which will require a 100mm timber joist plus the 25mm thick deckboard, EasyClick can be successfully used in areas with restricted height access, another significant advantage.



## STEP-BY-STEP INSTALLATION PROCESS

Once a structural deck has been constructed, either using aluminium frame (as pictured), if decking directly onto a concrete deck or if laying the battens onto Wallbarn adjustable pedestals (see below), the installation process is fast and straightforward.



The aluminium battens are laid down a **maximum of 400mm apart** in a line. As the deck boards are fitted onto the clips, they should be laid in a staggered formation so that one single board overlaps two battens at the joint, securing the battens together and securing the deck board to the battens.



Fitting the boards to the battens at right angles brings the system together and one layer secures the other. Steps, edges and borders can be accommodated easily. Installers can fix the aluminium battens to the vertical plane and fit the boards as cladding. EasyClick is ideal for use with Wallbarn Flat Headed adjustable pedestals and Mini Megapads.

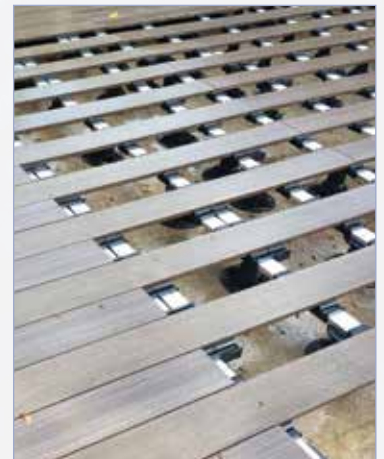

This means completely flat decking areas can be constructed on flat roofs, terraces and podium decks which are built to fall for drainage. **Installation is up to five times faster than by fixing decking by the traditional method.**



## REDUCED HEIGHT THRESHOLDS



Remember, with traditional decking methods a 100 x 50mm timber joist is required. In addition to the decking boards this creates a build-up of at least 125mm which can often be too great for door thresholds. EasyClick is only 52mm high including the rails and deck boards, so it is ideal for refurbishment work, and overlaying areas where door thresholds are very tight. Users can be assured that it will be strong enough over the long-term, due to the aluminium battens underneath.

## DETAILING

The aluminium battens can be fitted to the vertical plane to create steps or cladding sections. The installation is straightforward as long as the rails are laid dead straight and sufficiently secured. A special profile edging board is available to create tidy borders and edges. It will click securely into the clips in the same way as the deck boards as it has been moulded to exactly match the clip fittings.

For turns or end of runs, an alternative clip, Clip B, is available. The boards are fitted into one side of the clip at right angles to the other. This is particularly useful for sections where a lateral deck board is to be installed, for example over a roof section, which may need to be taken up at intervals.





## EASYCHANGE

EasyChange is the new alternative design for fitting these types of decking board. If users need to access the deck at intervals after installation, then EasyChange is the perfect solution.

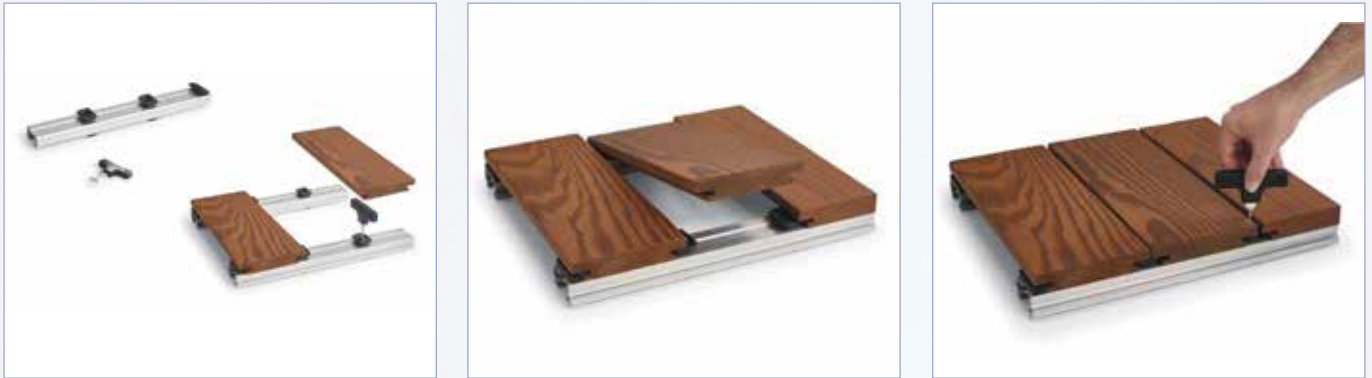

The EasyChange system has specially designed clips to hold the deck boards in place and by using a special key (supplied), the installers can remove any/all of the boards easily at a future date. This system means that the boards can be taken up and replaced multiple times without any of them becoming damaged, or the fixing clips deteriorating. This is a major advantage over screwed-in boards, as screw heads will become split when used repeatedly and the screw holes will become damaged over time. This is all avoided with the EasyChange system.

The clips have an ingenious patented design, and anchor the boards at the sides, so they will not damage them. These clips are shaped to provide easy access via the key, but cannot be moved or altered without it. Therefore, as a security measure, only authorised personnel will be able to remove any of the system.



The boards are manufactured with a slightly different shape and edge to the EasyClick boards, and the gap between each board is slightly larger, to allow access for the key. The appearance from above, however, is almost identical.

The end of the decking run can be finished tidily and securely using the special edge piece / stopper, which is screwed into the aluminium joist.

EasyChange is particularly suitable for cladding projects or areas of decking over items such as drains or service hatches. As well as the DURO EXCELLENCE composite boards, many types of tropical wood can be milled exactly to shape in the factory

**Further details are contained in a separate leaflet.**





## TYPES OF DECKING

### DURO EXCELLENCE

The composite decking product is a revolutionary new material. DURO Excellence is made from recycled rice husk and PVC to provide one of the most environmentally friendly and durable materials on the market.



Rice husk is a waste product and is normally burned, releasing CO2 and other seriously polluting emissions into the atmosphere. By using this waste product to form the organic content in the DURO Excellence decking, we save the associated emissions from entering the environment. DURO Excellence composite is completely recyclable, so at the end of the decking's lifespan, it can be converted into further materials and products in a safe and eco-friendly manner.

Because DURO Excellence has no wood fibre within it, it is a lot more moisture and mildew resistant than those composites containing wood flour or sawdust. It is an extremely tough and durable material that will retain its looks for the long-term. It is splinter-proof, ant-slip and is more UV resistant than other WPC based composites on the market.





DURO Excellence is the same colour throughout the depth of the board and is not just veneered, like some competitor products. This “real wood” effect, combined with the lack of visible fixings, gives it a most luxurious finish and highlights what a top-end system this decking system is.

The Virgin PVC and Rice Husk compound is coloured before the extrusion process, so colour uniformity and grain consistency is present all the way through each board. This means scratching and fading are far less of an issue when compared to stained composite boards. The texture also remains consistent throughout the entire board.

DURO Excellence comes in a number of different shades, textures and colours – 4 of which are held as stock items.



Moor Oak

Choco

Denim

Terra

Saddle

Teak

DURO Excellence offers the most natural looking effect which maintains its performance and appearance over a long period of time. It is difficult to tell that this is not real wood when viewed from a distance.





## INSTALLATION OF DURO EXCELLENCE USING EASYCLICK & EASYCHANGE



### TECHNICAL DATA

TEST	RESULT	STANDARD
TENSILE STRENGTH	35.1 N/MM <sup>2</sup>	
ELONGATION AT BREAK	3%	
THERMAL CONDUCTIVITY	0.15 W / (MK)	
DENSITY	CA 1280KG/M <sup>3</sup>	
NAIL WITHDRAWAL TEST	105 N	ASTMD 6117
SCREW WITHDRAWAL TEST	312 N	ASTMD 6117
HUMIDITY BEHAVIOUR	VERY LOW HUMIDITY ABSORPTION	
NO DIMENSIONAL CHANGE		
WATER ABSORPTION	0.26% - VERY LOW HUMIDITY ABSORPTION	
NO DIMENSIONAL CHANGE	ASTM D570	ASTMD 6117
LINEAR EXPANSION AT 40°C	0.13%	
<b>EMISSION TEST - TUV SINGAPORE, SEPTEMBER 2010</b>		
FORMALDEHYDE EMISSION	< 0.01 MG PER M <sup>3</sup> PER HOUR	
<b>PHTALATE EMISSION</b>		
DEHP (DI-ETHYLHEXYLPHTALATE)	< 0.003MG PER M <sup>3</sup> PER HOUR	
DBP (DI-N-BUTYLPHTALATE)	< 0.003MG PER M <sup>3</sup> PER HOUR	
BBP (BENZYBUTYLPHTALATE)	< 0.003MG PER M <sup>3</sup> PER HOUR	
FIRE RESISTANCE	CLASS B1	
<b>HAMBURG UNIVERSITY TESTS</b>		
SLIPPERINESS	PASS	CEN/TS 15676
FALLING MASS IMPACT RESISTANCE	PASS	EN 477
FLEXURAL PROPERTIES	PASS	EN 310
CREEP BEHAVIOUR	PASS	EN 15534
MOISTURE RESISTANCE UNDER CYCLIC TEST CONDITIONS	PASS	EN 321
SWELLING AND WATER ABSORPTION	PASS	EN 317
LINEAR THERMAL EXPANSION	PASS	ISO 11359-2

TEST METHOD	AVERAGE PTV
<b>DURO EXCELLENCE</b>	
DRY PRINCIPAL (DIRECTION)	59
DRY 45 DEGREES	125-160MM FLAT HEADED ADJUSTABLE SUPPORT PAD
DRY 90 DEGREES	185-220MM FLAT HEADED ADJUSTABLE SUPPORT PAD
RESULT:	62 LOW RISK
WET PRINCIPAL	
WET 45 DEGREES	
WET 90 DEGREES	
RESULT:	43.66 LOW RISK
<b>DURO</b>	
DRY PRINCIPAL (DIRECTION)	
DRY 45 DEGREES	
DRY 90 DEGREES	
RESULT:	61 LOW RISK
WET PRINCIPAL	
WET 45 DEGREES	
WET 90 DEGREES	
RESULT:	42.33 LOW RISK

## TROPICAL HARDWOODS

Both EasyClick and EasyChange can be installed with tropical hardwood as well as the composite material. The factory can mill the hardwood so that the boards fit accurately into the clips. The boards will be securely held without the risk of the timber twisting or becoming loose. The lack of visible fixings gives the deck a high quality look.

A summary of the different species is given below. Full technical data on all the timber species can be provided on separate data sheets. Some of the different types of timber used successfully with EasyClick and EasyChange include:

### IPÈ

The luxurious and hardwearing “Brazilian Walnut” is ideal for iDecking as it has very tight and smooth grains and does not twist or bend.

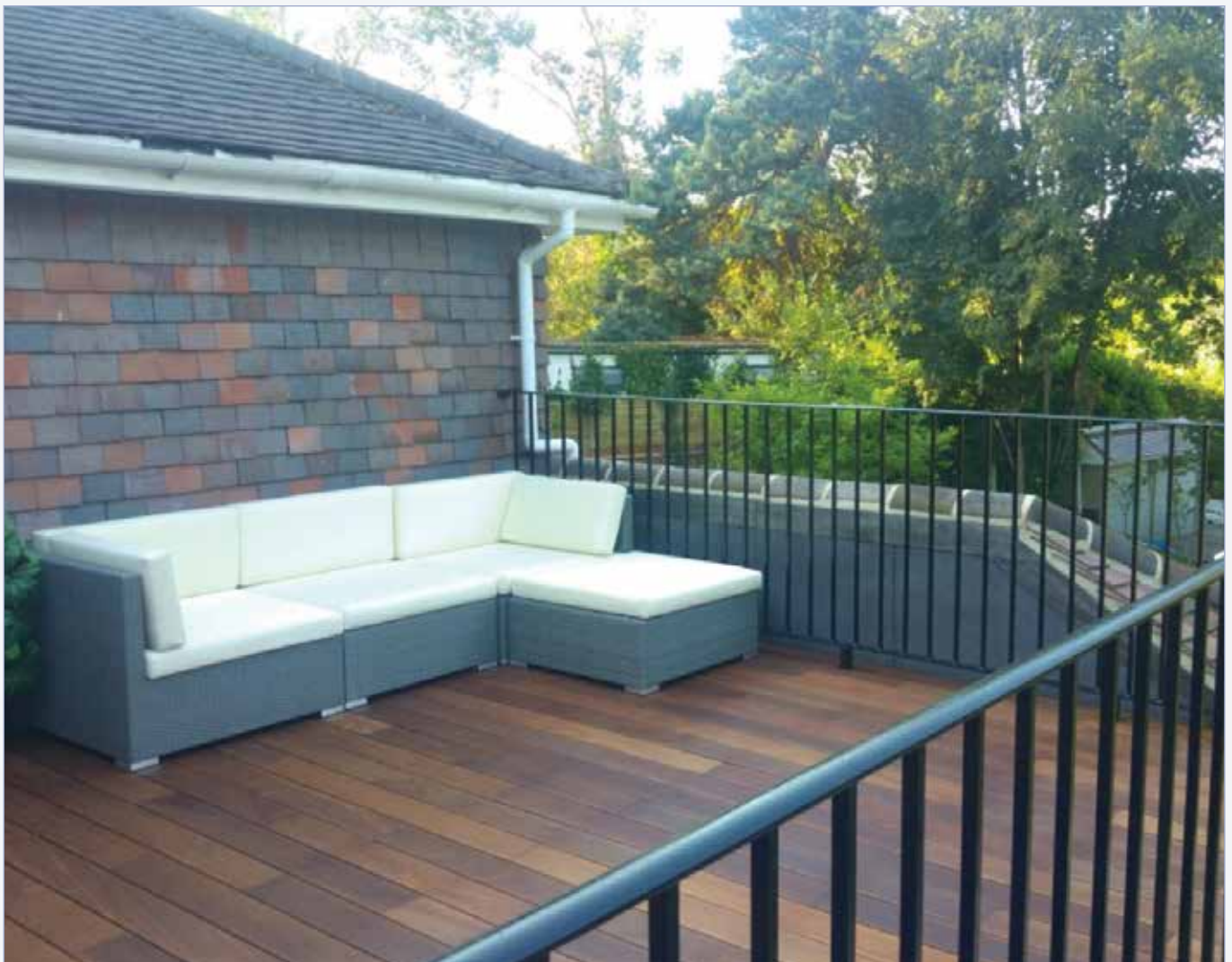



## ETHERNO BAMBOO

This steam treatment process turns bamboo into a super-hard, dark coloured, extremely attractive decking material. The thermo process actually makes it harder and more dense than ipe. Ethern Bamboo is a product which is not always considered for decking, and the thermo process creates a completely different appearance and texture. The Ethern Bamboo is an innovative material and further details are available in a separate brochure.

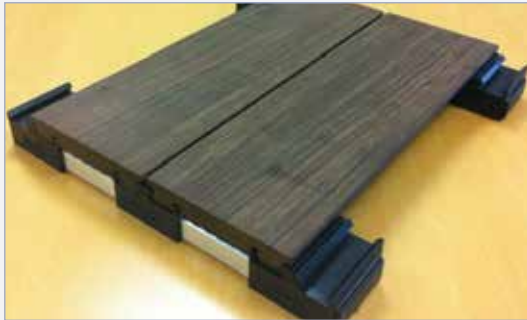

Bamboo is a product which is not always considered for decking, and the thermo process creates a completely different appearance and texture. The Ethern Bamboo product is a trademarked innovation and further details are available in a separate brochure.



## TEAK

Teak is a most attractive honey coloured hardwood which gives it a very different appearance to the IPE and Bamboo.



The mark of responsible forestry

## FSC® CERTIFIED TIMBER

Wallbarn has Forest Stewardship Council® Chain of Custody certification so can supply FSC certified timber. The FSC® scheme means that the certified timber can be traced back to well-managed forests in accordance with the rules of the Forest Stewardship Council®.

Every party, from the grower to the processor to the manufacturer of the tiles to the end user is tracked and audited to ensure that they have complied with the ethical and well managed forest practices laid down by the FSC®. The whole chain is monitored. **FSC® 100% Chain of Custody certified timber – number SGS-COC-007242.**

Only fully certified companies within the Chain of Custody can use the official FSC® logo against FSC® certified timber. FSC® credited timber is clearly distinguished and marked as separate from non-FSC timber and the mark can only be used with FSC® material. Please contact us for full details of compliance to FSC® Chain of Custody and more information on the scheme.



## OILS & MAINTENANCE PRODUCTS

Wallbarn supplies a large range of oil and maintenance products which are available for DURO Excellence composite and hardwood decking. They are designed to protect timber and composite materials from dirt, UV, turning grey and adverse weather conditions in the long-term.

### FOR DURO EXCELLENCE COMPOSITE MATERIAL SEALING / PROTECTING

#### DURO SHIELD – FOR BEFORE USE

**DURO SHIELD** is a protective solution used to preserve and protect the DURO Excellence boards used on the EasyClick and EasyChange decking systems from Wallbarn. **It should be applied to the boards before or during installation and before use.**

This solution is water-based and helps to seal the decking, preventing water and oil stains. It also protects against UV fading and is available in 5ltr tins. Coverage is 8-10m<sup>2</sup> per litre.

#### DURO DROP – FOR BEFORE USE & FOR ANNUAL MAINTENANCE

**DURO DROP** is a clear, water resistant solution designed to prevent water ingress and water stains on DURO Excellence decking boards.

This solution is applied with a cloth or soft brush. The boards should be rinsed after cleaning with water. DURO DROP is available in 5ltr tins and is 90% biodegradable.

### CLEANING

#### DURO CLEANER

**DURO CLEANER** is a clear detergent based washing solution used for normal and regular maintenance of DURO Excellence decking boards.

This solution should be applied with a cloth or soft brush and diluted 1 part solution to 4 parts water. DURO CLEANER is supplied in 5ltr tins and is 90% biodegradable.

#### DURO INTENSIVE CLEANER

**DURO INTENSIVE CLEANER** is a concentrated stain removing solution supplied in an aerosol can used to remove deep stains, oil spots and ground-in dirt. It is designed for use with DURO Excellence decking boards.

Spray directly onto the stain, leave for 2 minutes then rinse the boards with clean water. The aerosol can is 0.2 ltrs.

### FOR HARDWOOD

#### MYDECK+ WOOD OIL - LIGHT

**mydeck+ WOOD OIL – Light** is a natural, neutral coloured, clear oil used to revitalise and protect hard and softwood, protecting it against attack against both mould and infesting organisms.

**mydeck+ WOOD OIL – Light** is available in 1ltr, 5ltr and 25ltr tins and will cover approximately 10m<sup>2</sup> per ltr.

#### MYDECK+ SOAP

**mydeck+ SOAP** – this detergent is developed to protect exterior wood applications. It is an effective remover of dirt, residual chlorine, salt and spots. It is safe to use with the wood and does not leave stains. It should be used in conjunction with mydeck+ WOOD OIL. It comes in a 3ltr tub.

#### MYDECK+ GREY OFF

**mydeck+ GREY OFF** – is designed to remove the grey oxidation which can build up on the timber.

It regenerates wood that has become grey and helps to restore the original colour of the wooden objects that have been exposed to the elements. It will not damage expansion joints or rubber and is biodegradable. It comes in a 3ltr tub and will cover approximately 15m<sup>2</sup> per ltr.



All of these oils and maintenance products should be installed at temperatures between +10°C and +25°C. **Full technical details and installation instructions can be provided on request.**



## GREEN ROOF SYSTEMS

Green roofs are used to provide visual aesthetics to the construction project, to introduce nature back into cities and to mitigate the impact of densely populated urban areas. They are a useful and increasingly cost effective way to provide attractive, useful, environmentally friendly open spaces on otherwise 'lost' flat roofs and podium decks.



Green roofs are very adaptable and can be designed for large or small areas on most structural decks. However, truly understanding the horticultural requirements of introducing vegetation onto artificial surfaces is a discipline which requires specialist skills and knowledge. All green roofs need light, water, drainage, and correctly engineered soils. Without ALL of these elements the green roof vegetation will not thrive. Wallbarn green roof systems are constructed in order to provide sustainable long-term vegetation and to minimise maintenance.



Wallbarn has many years of experience in landscaping and green roofing technologies. We are constantly innovating and developing new products and techniques to improve and enhance rooftop living.



## WALLBARN GREEN ROOF SYSTEMS GIVE THE FOLLOWING BENEFITS

### IMPROVING THE ENVIRONMENT

Provides valuable habitat

Attracts insects, invertebrates and birdlife

Absorbs CO<sup>2</sup>, pollution and dust particles

Combats the Urban Heat Island Effect

### INSULATION

Reduces transmission of noise and vibration

Thermal insulation – absorbs solar heat, provides valuable cooling

### RAINWATER ATTENUATION

Absorbs rainwater in the substrate and from vegetation uptake

Reduces the amount and speed of rainwater run-off

Delays run-off before rainwater starts to escape from the roof

Puts less pressure on drainage systems as a whole

Enhances water harvesting systems



### BALLASTING INVERTED WATERPROOFING SYSTEMS

A valuable and attractive alternative to pebbles or concrete slabs on rooftops to hold down insulation boards or loose laid waterproof systems

### PROTECTING THE STRUCTURE AND WATERPROOFING LAYER

By covering the waterproofing membrane damage caused by UV, impact and abrasion, plant and bird infestation is prevented

Reduces and regulates the temperature of waterproofing, reducing surface thermal movement

### OPTIMISING THE DEVELOPMENT FOOTPRINT

Provides additional green space and helps BREEAM ratings

Provides an attractive feature for occupiers to utilise

Brings a feeling of open space to high density environments

Helps with the planning permission process

Can increase the value of the development

### EASY TO INSTALL

All Wallbarn systems have been developed to accommodate straightforward, non-complex installation and build-up – improves speed and reduces costs

## M-TRAY® MODULAR GREEN ROOF SYSTEM

Wallbarn has developed a modular **M-Tray®** system which makes installing sedum and wildflower green roofs incredibly easy, with far less disruption to both plants and structure than other methods. The modules are self-contained - the sedum within also being well-established - and simply click together to create a seamless, instant green roof.

We continue to develop our **M-Trays®** including improving the make-up and quality of the substrate used, which in turn produces stronger, healthier, lusher-looking plants all year round.

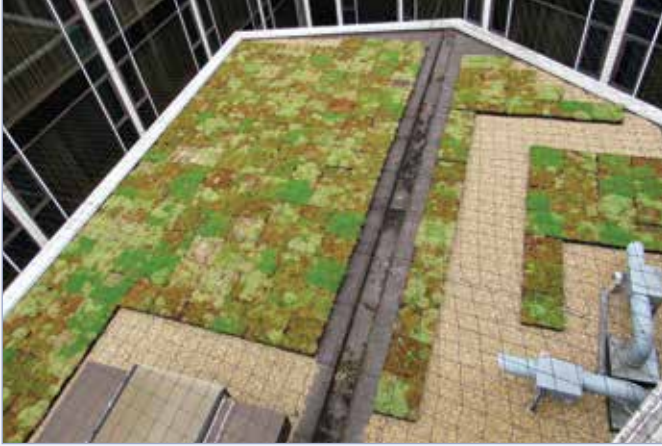

Wallbarn is at the forefront of developments in the green roofing sector and has always provided products that combine top quality ingredients with user friendly, hassle-free maintenance. The purpose of **M-Tray®** is to enhance rooftop living.



Our unique, modular design allows us to supply the best quality vegetation to site. The fully established, mature sedum or wildflower plants are contained within easy-to-carry trays which click together to form an almost invisible joint. **M-Tray®** has been specifically designed and patented\* with the installer in mind. This is not an adapted tray, it is designed specifically for purpose. Exactly 4 units per m2 make estimating and installation much easier.



WALLBARN IS A MEMBER OF THE GREEN ROOF ORGANISATION (GRO)  
SUPPORTS THE UPDATED GRO CODE FOR GREEN ROOFING.

\*M-Tray® has been designed and developed by Wallbarn in UK and is the subject of Community Registered Design (No. 002953943-0001) and US Registered Design (No. USD787,186S)



## WHY MODULAR?

The main advantages of modular over roll-out green roof systems surround convenience, speed, future-proofing and instant results. All the elements required for a successful green roof have been measured and installed into the **M-Tray**<sup>®</sup> modules at the nursery, so users can feel confident that the plants, growing medium and filtration components are suitable and compatible, and at the correct level to give strong, healthy growth over the long term.

The trays are grown for a period of at least 6 months and all will have been through at least one spring growing season; so the plants are well established, healthy and strong, and fully integrated into the substrate (unlike sedum blankets, which are not).

### Convenience

Mess and disruption can be a problem with roll-out systems. Bags of aggregate-based substrate can spill easily and, being so granular, can damage waterproofing membranes. Sedum blankets are also supplied rolled up, so the plants get damaged during the transport and installation process. Our **M-Tray**<sup>®</sup> modules overcome all of these issues.

### Accessibility

As each module is 500 x 500mm, one **M-Tray**<sup>®</sup> can be carried by one operative. For areas which are very difficult to access, such as single storey extensions, domestic projects and other completed structures, roll-out is simply not possible. **M-Tray**<sup>®</sup> can be hand-balled into even the most awkward areas, even carried through a window (pictured) if necessary. They are the perfect retro-fit product.



### Speed

It is estimated that our **M-Tray**<sup>®</sup> can be installed at least twice as quickly as roll-out systems. A team of contractors can easily install approx. 400 square metres in a day.

It is also an instant green roof. Since the plants are less shocked by the installation process, as soon as the trays are connected together the whole area is filled with well established plants. They will continue to mature straight away, forming a seamless layer of vegetation much faster.

Access to the roof is future-proofed. If there are problems with the deck beneath or inspection is required, one **M-Tray**<sup>®</sup> or section can easily be lifted out without disruption to the whole roof.



## THE DESIGN

### Shape

**M-Tray®** has been especially designed for the extensive green roof market.



The module measures 500 x 500 x 100mm. As four units make up exactly one square metre estimating is a far easier process.

There are less drainage holes than in previous versions to keep water within the green roof system for longer. This allows the plants to absorb more rainfall, increasing attenuation and delaying discharge into outlets.

Our unique blend of substrate helps reduce rainfall run-off as well as providing greater and prolonged hydration during dry periods. The edges of the module do not have drainage holes in order to prevent the sedum dying back at the edges.

Stronger plant growth at the edges creates a more seamless layer of vegetation when the modules are connected. Four gently ridged hand grips are positioned to enable installers to carry each module easier.

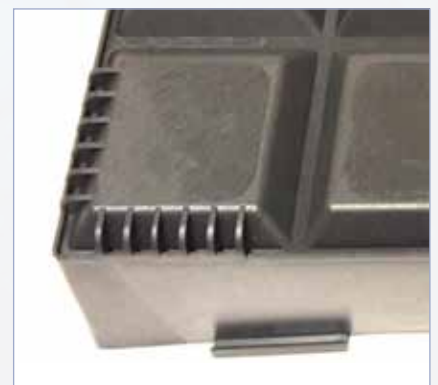

### Smooth edges & connecting bracket

The connecting brackets are designed to give a tight connection, with the minimum of gap between each module. The joint is only 4mm so the plants will grow over it quickly, making it disappear in ultra-quick time (white units for illustrative purposes only - all **M-Tray®** units are supplied in black).

The corners of the modules are rounded and smooth, so no sharp edges (which might puncture the membrane beneath) are present. It also makes handling the trays easier and the edges can be mounted onto Wallbarn pedestals if additional height is required.

### Trims & edging

100mm aluminium edge trims and connectors fit neatly onto the sides of the modules. Fixings are not always necessary and they are designed to slot together neatly.





## STEP BY STEP INSTALLATION

Wallbarn **M-Trays**<sup>®</sup> have all the necessary elements contained within them.

So no bulk bags filled with sharp aggregate or sheet membranes blowing away in the wind.

**M-Tray**<sup>®</sup> modules are transported to site on strapped pallets for easy, clean delivery. They can then be craned safely onto the roof if necessary.

Unpacking the pallets is a simple process. None of the contents will spill out and each module can be carried by one person.



1. A separation and filtration geotextile layer should be firstly installed onto the deck. This protects the waterproofing and prevents abrasive damage. Wallbarn usually supplies a 300gsm recycled fleece for this purpose.

2. Start from the middle of the green roof and work outwards towards the edges. Place a module down and then click the next into place. There are two connection points on two sides of each module. Once connected up on all four sides, the module will be secured on all four sides.



3. The edges should be filled with a border of washed riverstones, in accordance with the GRO code of practice. Objects such as roof lights and cables should be surrounded with riverstones to prevent root invasion and act as a fire break.

An aluminium edge trim can be added to any exposed edges or where the stones need to be held away from objects such as drainage outlets.





The modular sections mean detailing around objects is a simple process and clean lines are created. Hard landscaping sections such as paving and decking, mounted onto Wallbarn pedestals, can be added to the area to allow for regular access. As everything is suspended on top of the deck, drainage is uninterrupted.



Pop-up sprinklers or other features can be installed in conjunction with **M-Tray®** to further improve the landscaping. **M-Tray®** provides real landscape solutions and enhances rooftop living!

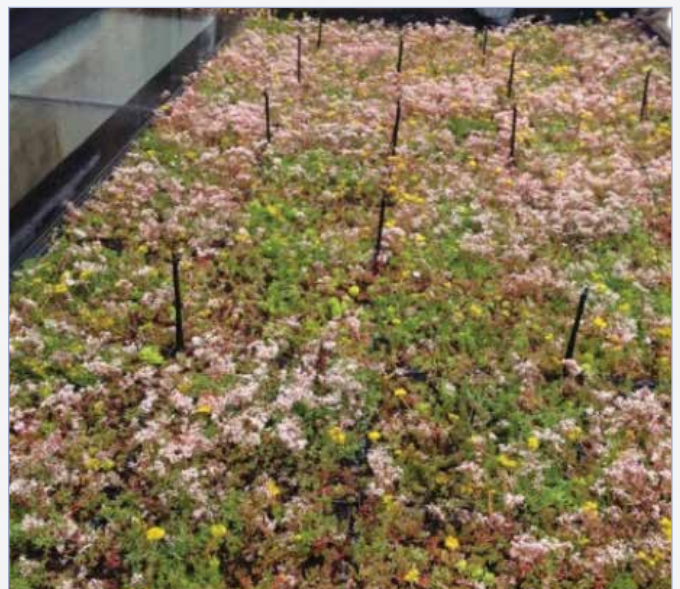



As well as the sedum trays, Wallbarn plants up a wildflower mix into the **M-Tray**<sup>®</sup>. A varied mix of at least thirteen different sedum species has been selected. All these flowers and herbs are low growing, hardy species, chosen to be pollinators for butterflies and bees.

Semi-mature plug plants can also be grown into the **M-Tray**<sup>®</sup> modules.



Our **M-Tray**<sup>®</sup> modular system has to be one of the fastest, most trouble-free ways of constructing a roof garden, and bringing nature to the urban environment.



## KEY ADVANTAGES

The advances made in the design of the M-Tray® model include:

- deeper cavities for extra root growth
- optimum drainage leading to stronger plant growth
- more established vegetation at point of installation
- more efficient transport and packaging
- exactly 4 units per m<sup>2</sup>
- easier to carry trays with smooth handles
- closer connection between trays for more seamless plant growth
- no sharp edges, less risk to the membrane
- nothing spills out, less mess
- made from recycled plastic with recycled substrate
- less packaging, less waste
- designed and manufactured in UK
- designed for the job

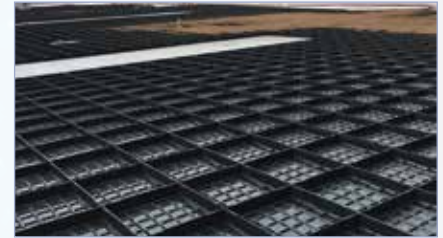

## EXPORT & LICENSING OPPORTUNITIES

As well as supplying live products for installation on UK green roofs and landscaping spaces, Wallbarn is committed to **M-Tray®** as an export product.

We can supply the modules as empty trays for local landscapes worldwide to plant up and propagate according to the local climactic conditions and their own markets.

**M-Tray®** has been designed and developed by Wallbarn in UK and is the subject of Community Registered Design (No. 002953943-0001) and US Design (No. USD787,186S). Further worldwide design registrations are currently being carried out.

Licensing opportunities are available for both the **M-Tray®** brand and the mould, which can be granted to specific partner companies across the globe.

An **M-Tray®** "Bible" is available to guide partners in the growing and installation process and we can draw on many years of experience.

## TECHNICAL DATA

PRODUCT	M-TRAY® MODULAR GREEN ROOF CONTAINER
SUITABLE FOR	EXTENSIVE GREEN ROOF PLANTS WITH LIGHTWEIGHT, FREE-DRAINING SUBSTRATE
TYPE OF CONSTRUCTION	PERMANENT
WIDTH / BREADTH	500MM X 500MM
HEIGHT	100MM
SHAPE OF WALLS / SIDES	TAPERED / ANGLED
UNITS PER M <sup>2</sup>	4
MATERIAL	RECYCLED POLYPROPYLENE
THICKNESS OF MATERIAL	3MM
INTERNAL RIDGE HEIGHT / RESERVOIR HEIGHT	20MM
NUMBER OF INTERNAL DRAINAGE RESERVOIRS	25
DRAINAGE HOLES PER UNIT	8
DISTANCE BETWEEN TRAYS AT BASE	20MM
DISTANCE BETWEEN TRAYS AT 50MM FROM BASE	10MM
DRY WEIGHT (EMPTY)	1.1KG
WEIGHT FIELD CAPACITY ❶	32KG
CONNECTORS PER UNIT	4
NUMBER OF HANDLES ON UNDERSIDE	4
DETAIL OF CORNERS / EDGES	SMOOTH / REINFORCED
EU DESIGN TRADEMARK	NO 002953943-0001
US DESIGN TRADEMARK	NO 29/553,129
❶ FILLED & FULLY PLANTED FIELD CAPACITY OF WALLBARN SUBSTRATE & MATURE SEDUM PLANTS DURING / AFTER ABNORMAL RAINFALL CONDITIONS.	



## ROLL-OUT EXTENSIVE GREEN ROOFS

The roll-out green roof is a simple, low maintenance sedum green roof system where each element is supplied separately and installed layer by layer. It is an effective way of greening a roof deck and bringing a sense of nature to built-up areas.



The main features of extensive green roofs are:

- lightweight systems – can be as light as 50kg per m<sup>2</sup>
- total build-up depth – 100-150mm thick
- simple vegetation – mainly sedum
- drought tolerant
- saline tolerant
- low maintenance requirement
- irrigation systems optional

Extensive green roofs are designed to be lightweight. Therefore, they can be used on a large variety of structures.



The sedum plants we use have been selected to be easy to manage and do not need a large amount of watering, making them ideal for areas which may be overlooked but are difficult to access and maintain.

The sedum blankets contain a mixture of different species of sedum, specifically selected to provide a variety of different textures, colours and flowering periods and are supplied with at least 85% coverage. They are designed to give consistent, all year round coverage of vegetation throughout the year.

Mixes of wildflowers, herbs and bulbs can also be incorporated into the blankets. We supply healthy, freshly cut sedum blankets.



## INSTALLATION

Extensive green roof systems are built up in individual layers from the waterproofed deck or insulation layer (inverted roof).

Each element of the system is supplied separately: the substrate will be delivered in bags, the drainage and filtration membranes come in rolls and the sedum is usually supplied rolled up into sedum blankets. They are delivered to site on pallets and will need to be moved to the roof top carefully to avoid damage.



The build-up is made up as follows (from base upwards):

- Wallbarn recycled polyester geotextile filter fabric. Wallbarn supplies a range of different geotextile fabrics and we recommend a fabric of at least 300gsm – code GE-PE-PECT-0300-Z.
- Protecto-drain. Flexible, cusped and perforated membrane (made from HDPE, available in 8mm or 20mm, depending on drainage / attenuation requirement). This is loose laid onto the geotextile, cup-side up. This collects water but also allows excess water to escape through the perforations into the roof outlets.
- Wallbarn recycled polyester geotextile filter fabric, to allow water to pass through the system but to prevent substrate particulates from blocking the drain.
- Lightweight engineered substrate (manufactured from a blend of crushed aggregate and green waste to form a gritty mineral based low nutrient mix).
- The sedum blanket is then rolled out onto the substrate and gently pressed into place. Alternatively, plug plants are distributed over the surface.





## BIODIVERSE ROOF SYSTEMS

Biodiverse roofs and brown roofs are two different things:

- Biodiverse roofs are where seed or plants are introduced into the substrate at the time of construction.
- A brown roof is where the substrate surface is left to self-vegetate from windblown and bird lime seed dispersal.

After several years both type of roof may look the same as the vegetation reaches a maturity.



They have become a popular type of roof garden finish in recent years as they are seen by many planners as a more natural, rugged urban feature and can offer a greater diversity of species as well as prolonged foraging for insects. The concept of biodiverse roofs is that a plain, low nutrient environment is created at roof level.

Tough, hardy plants will start to germinate in the substrate in a natural way, replicating wild urban spaces that are found at ground level. Wallbarn uses wildflower seeds that are mixed into the substrate, plug-plants or our new pre-seeded BeeMat (two layers of biodegradable fabric impregnated with wildflower seeds to guarantee an even spread, and to provide an ideal climate for germination).

Biodiverse roofs require fairly little maintenance. They still offer sound acoustic and temperature insulation properties to the building, and will help to attenuate water runoff from the rooftop to a significant degree. The substrate level is normally up to 150mm, which offers a medium weight build-up, usually no heavier than 120kg per m<sup>2</sup>.

Often objects such as rotting tree stumps, stones and rocks can be introduced onto the area to encourage insects and other wildlife. Waste material from the construction process, such as crushed aggregate and concrete, can be introduced into the substrate, adding to a sense of recycling elements of the project.

**However, caution must be exercised when using waste from the site to avoid contaminated material or sharp objects, which could damage the waterproofing being placed onto the roof.**

Biodiverse roofs can be used to replicate and replace the ground terrain prior to construction taking place.

Wallbarn **M-Tray**<sup>®</sup> can be produced as biodiverse modular roof system by adapting substrate and vegetation type to suit the project requirements.

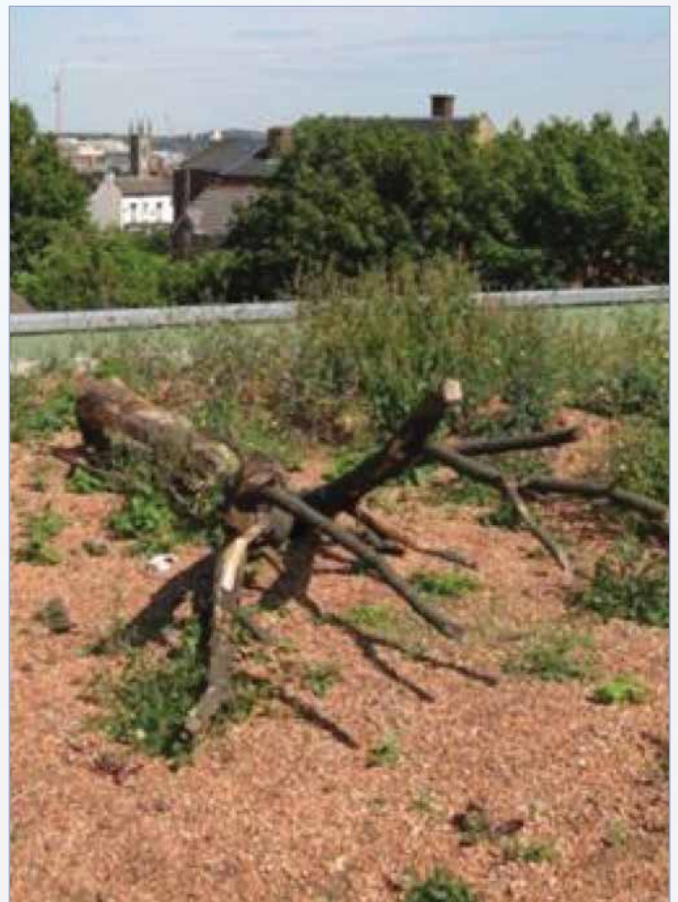



## INTENSIVE GREEN ROOFS

Intensive green roofs consist of much deeper substrates which give far greater scope to design and grow more interesting and elaborate gardens onto concrete decks.

They are more akin to traditional landscaping but positioned on a roof.



So long as the structure can support the weight, almost unlimited planting and landscaping can be achieved, including large shrubs, grassland, flowerbeds and even trees. Intensive green roofs tend to be areas where greater access and people traffic is envisaged.

Intensive green roofs offer considerable benefits to the urban landscape far and above anything a light sedum roof can offer. With the increased soil levels and intricate planting, natural gardens and parkland can be recreated on rooftop level. Wallbarn provides design consultation to integrate hard and soft landscaping materials to maximise the project potential.

We supply all components required for intensive green roof systems which allow the installer to purchase drainage materials, soils and other associated products from one single source. Issues such as increased weight, irrigation, and maintenance, need to be considered at early design stage.

- Intensive green roof systems magnify the environmental and aesthetic benefits of green roofs
- They offer greater biodiversity
- There is more dust and pollution absorption
- They give a higher level of water attenuation and delay of water run-off
- They give improved thermal and sound insulation benefits
- Lush, luxurious roof gardens have been proven to increase the value and accelerate the take-up of buildings when offered on the market. This can increase the speed of sale as well as rental yield
- The footprint of the building is being optimised. There is less wasted space in densely populated areas and there is increased amenity value

The build-up of intensive green roof systems differs from project to project and as such, Wallbarn should always be consulted at concept stage to advise on correct product selection and use, particularly in relation to the vast array of waterproof systems used in UK. Intensive green roofs are also far more complex than the sedum and extensive roofs. Even with lightweight materials being used in the soil substrate, the depth of it means weight loadings are vastly increased.

Therefore a different protection, drainage and filtration build-up is required for increased drainage capacity and load bearing. Irrigation needs to be anticipated at an early stage. Designers need to imagine what they want the gardens to look like post construction. This will dictate the plant selection, which will in turn dictate the levels of irrigation and weight of saturated soil within the system. Structural engineers need to be advised of the stresses involved at design stage – not at retro-fit stage.



## ACCESSORIES FOR GREEN ROOFS

Wallbarn provides solutions for rooftop living and we offer a number of products to help complete the whole landscaping package.

### ALUMINIUM ANGLE

Parapets and upstands should be kept clear of plants, to avoid roots clogging outlets and vents, and to reduce fire risk.

This is in accordance with the GRO code of practice for green roof construction.

A border of rounded riverstone pebbles should be constructed around the edges. An aluminum angle should be installed to create the separation between those growing elements and areas such as drains and roof lights.



The profile is right angled, so it can sit underneath either the **M-Tray**® or the pebbles and be weighted down sufficiently.



It can be mechanically fixed to the surface beneath, but if this is not possible due to the waterproofing membrane's integrity, the angle can be ballasted.



Where there is an exposed edge with no parapet, the perforated aluminium angle can be used to provide an edge to the green roof itself. It is recommended that the angle is mechanically fixed to the deck in some way. The pebbles are then installed the other side. This ensures free flow of drainage water.

### IRRIGATION SYSTEMS

Wallbarn can supply a range of irrigation systems for installation with extensive sedum green roofs as well as intensive roof gardens.

These range from simple timer based sprinkler networks to fully automated, web based irrigators, which will feature drought and leak detectors, separate growing zones and control panels.





## HARD LANDSCAPING

Green roof systems, whether being the roll-out version or **M-Tray**<sup>®</sup>, can be constructed so that soft landscaping and hard landscaping fit seamlessly.



Areas such as paving or timber decking (laid onto Wallbarn ASP or TD pedestals) can be built up to the same height as the vegetation, creating one seamless garden level.

## SUBSTRATE FOR GREEN ROOFS

Wallbarn has developed its own specially designed substrate to nurture and sustain sedum and wildflower plants in the longterm on green roofs. We have worked with leading stock growers, construction consultants and soil experts to develop a suitable substrate for use in green roofing.

We have tested substrate components and ingredients both in the laboratory and in field trials; over a period of more than 24 months to establish the optimum.

The key requirements for this specially mixed compound which we have ensured are included are:

- A free draining mix – water needs to be able to escape to avoid overloading the roof and drowning the plants.
- Lightweight substrate – sufficient ballast to prevent wind erosion is needed but heavy ingredients should be avoided.
- Strong healthy plants – compare the root growth in Wallbarn's **M-Tray**<sup>®</sup> modules, reaching down to the full 100mm to green roof systems which use only rubble or crushed bricks. Rubble will compress to a solid mass over time and the roots cannot penetrate it, leading to weak plants and significant die-back.
- Nutrient levels – the substrate cannot be simply brick dust as

this prevents root growth. The mixture needs to have enough nutrients to help the sedum plants grow and develop, but not too high a nutrient level as this can encourage growth of weeds.

- Longevity – we need to ensure that the substrate does not oxidize to too great a level. Some topping up will be required on all green roofs as nutrients are used up and plants grow, this substrate is developed for long-term plant sustenance.
- Sustainability – although the exact recipe of our mixture is a closely guarded secret, we use recycled green waste from a variety of sources, recycled coir, our own compost, local grit/aggregate and recycled construction waste to create our substrate mix.



We can supply this substrate in 25 kg bags for smaller projects or in 1m<sup>3</sup> jumbo bags for larger projects. Ask us for more details.





## DRAINAGE PRODUCTS

For roof drainage, tanking, waterproofing and ground level water management.

### PROTECTO-DRAIN MEMBRANES



### PROTECTO-DRAIN DRAINAGE CHANNEL



### ROOF OUTLETS & DRAINAGE





## PROTECTO-DRAIN



Protecto-drain is a preformed high density polyethylene (HDPE) membrane designed to protect surfaces and act as a drainage layer. It is manufactured with a series of cups and ridges to help channel water effectively.

Made from HDPE, this hard wearing flexible membrane is designed to direct water away from the surface of the structure, towards the appropriate drainage system.

It is very tough but lightweight and easy to handle, making it very adaptable and suitable for a large number of applications.

It is available in a range of sizes and thickness for different strength requirements and flow rates. It is also completely safe and contaminant free, and can be used safely with water courses.

It is ideal for vertical surfaces and protects the waterproof membrane from abrasion and puncture damage caused by backfilling. Its cupped structure creates a permanent air gap between the wall and the backfill which helps to reduce pressure points and helps in the ventilation of the building and alleviate problems with damp.



It is also an effective damp-proof layer on horizontal surfaces. It is fungus and rot-proof and completely safe with drinking water.

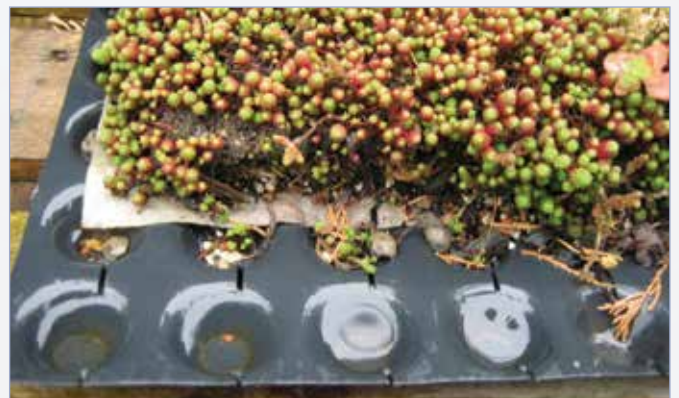

By designing an “egg-box” profile, blockages are prevented and a greater amount of water can pass along the membrane. This profile also allows very easy sealing of the membrane, as multiple sheets can be “clipped into place” by overlapping the cups and sealing the joints with adhesive tape.



## PROTECTO-DRAIN 8

Protecto-drain 8 is a single membrane fixed to the wall with its cups facing towards the backfill. It spreads the weight of the soil and prevents point loading onto the structure.

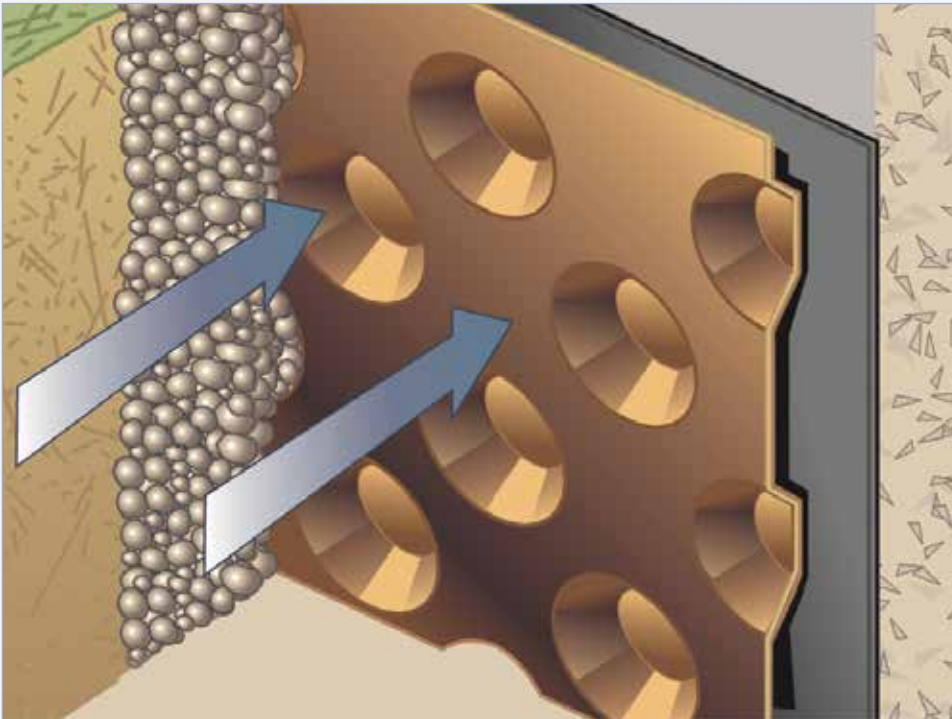

The 8mm high cups create an air gap between the structure and the earth backfill, helping to ventilate it effectively.

Providing that the membrane is properly sealed at the edges, Protecto-drain 8 can create a viable waterproofing membrane in itself. It is best suited, however, as an extra protection and ventilation layer, covering an existing waterproofing seal.

Protecto-drain 8 is very flexible, and can be folded and shaped around awkward areas and details without compromising the seal.

Because it is so lightweight, it is ideal for fixing to the vertical plane. It is easy to cut around details and edges and multiple sheets can be fitted together. It should be fitted so that it emerges above the surface ground level to ensure the air gap does not become blocked or flooded.



Protecto-drain 8 is available as a standard 550gsm membrane. Special lightweight or heavy duty versions are also available.

The sheets are fixed to the structure either by passing nails through special sealing plugs onto battens or by using a double-sided bitumen tape at the edges of the sheets and across the joints.

Each sheet should be overlapped by 20cm, with the egg box shaped cups slotting neatly into one another, producing a good fit. Using tape across the joints is advised to ensure a proper seal throughout the whole area.



## PROTECTO-DRAIN G8

Protecto-drain G8 is suitable for areas with a much greater amount of water passage and pressure through the ground. It has a 100gsm geotextile fabric bonded to one side.

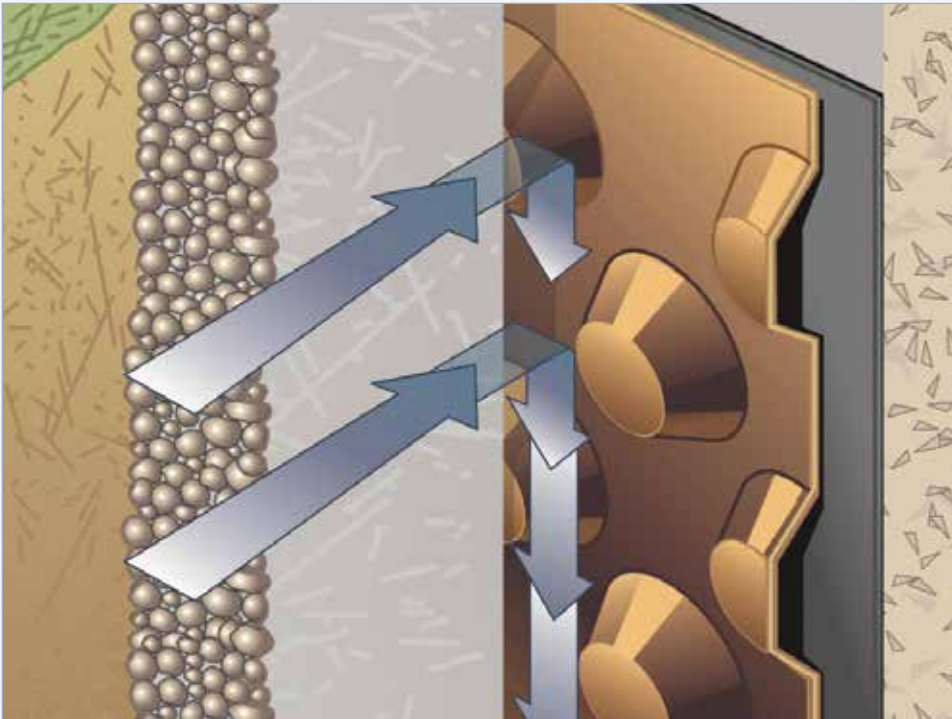

This gives additional protection to the membrane and also helps to filter out particles whilst allowing the water to pass through the fabric and into the air gap drainage chamber.

With moisture passing through the geotextile but no soil moving, the area around the structure is effectively drained but the ground remains stable and firm, greatly reducing the risks of subsidence or hydrostatic pressure building up.

Protecto-drain G8 as a material is completely safe with drinking water.

Protecto-drain G8 is ideal for planters and tanking. It is essential to avoid vegetation becoming waterlogged in planters but at the same time ensuring an even flow of moisture through the soil so that flood channels are not created in the planter, which can also damage the roots of the plants.

Basements and subterranean structures will come into contact with significant moisture, so a way to channel this moisture away from the concrete is required. A suitable exit for the water should always be designed into the waterproofing system.



As the water drains vertically down the membrane, it is channelled through the geotextile fabric and into a perforated pipe.

The pipe should be fitted to either a natural drain or a pump to ensure the water moves away from the structure effectively.

Protecto-drain G8 has also been used successfully on a horizontal plane as a drainage membrane beneath blockwork and paving slabs.

The rainwater runs through the slabs and insulation, then through the geotextile fabric and runs along the HDPE membrane into the roof outlet. This prevents standing water puddling on top of the slabs and gives effective drainage.



## PROTECTO-DRAIN 20

Protecto-drain 20 is a more heavy duty 1mm thick HDPE membrane which is useful for larger scale areas of tanking and sealing. It has a larger cup size of 20mm which allows a greater amount of ground water to pass along the membrane.



It is ideal as a lining membrane, as a waterproofing and protection layer between layers of concrete, on foundations, bridges and tunnels, and a whole manner of civil engineering works.

The flexible and easy-to-bond nature of the material makes it easy to install, and it can cope with larger quantities of ground water and drainage easily and hydrostatic pressure points are prevented.



The HDPE material will not pollute the water running off in any way, which means it can be managed and recycled.

It is tough enough to tolerate a wet concrete pour without risk of damage. When installed between two layers of concrete the cupped profile ensures a constant air gap between the two concrete layers, meaning the fabric of the building is sealed at the sides, so there is no risk of damp creeping into the concrete even if the building is subterranean in part.



It is used extensively in horizontal installations beneath the initial concrete slab layers, where it is effective in preventing seepage water from below entering the foundations. Each individual sheet can be bonded together by overlapping the cups and sealing with tape, meaning the layer is completely waterproof. Since it is flexible, any undulations and imperfections in the ground below can be accommodated without risk to the seal. Rebar can be laid directly onto the membrane without damage and concrete can be poured.



## PROTECTO-DRAIN 20P

Protecto-drain 20P was developed for use as a reservoir and drainage layer in green roof construction. It is placed on top of the waterproofed, protected concrete deck and sits beneath a filter layer, the soil substrate and vegetation layers, on extensive green roof systems.



The HDPE membrane is manufactured with the same 20mm cups, but the area between the cups is perforated.

Wallbarn Protecto-drain 20P is lightweight and easy to transport and install, making it ideal for rooftop applications.

On a horizontal plane, this allows water to fill up in the cups helping to sustain the roots with any excess water escaping through the holes and able to run away beneath the membrane into the drainage outlet.

The egg-box creates a constant air gap, allowing the excess water to pass easily without clogging.

The water held in the cups can then be drawn back up through the filter layer to nourish the vegetation above. This means that a constant level of water can be held in the reservoir cups, but rainwater is efficiently removed effectively and quickly from the roof, which will not become overloaded (never underestimate the weight of standing water).



This is a simple but effective way of holding a modest amount of water beneath the root systems.

It is important to remember, however, that these materials alone do not provide a drought resistant system. Regular watering and maintenance is required for all roof gardens and green roofs.

Protecto-drain 20P is suitable for EXTENSIVE green roof systems with substrates up to a depth of 200mm. Protecto-tape double sided bitumen tape is also available for securing sheets together or bonding the membrane to a dry structure.



## PROTECTO-DRAIN ACCESSORIES



A variety of accessory products are available to finish off and help fix the HDPE membranes to structures.

An edging profile can be fitted above the Protecto-drain membrane to give a permanent air gap, allowing the structure to breathe. Particles and surface water will be prevented from passing down behind the plastic membrane but the air gap will ventilate the structure effectively.

Protecto-drain flexible HDPE membranes can be fitted to the structure using special fixing buttons, which fit into the dimples of the membrane. A nail is passed through the centre, and the buttons seal the hole made by the nail, helping to keep the membrane watertight.



For longer fixings specialised anchors made from metal or plastic can be used to pass through the membrane. The plastic anchor has a ridged shaft to maintain a strong bond into the structure.



Being bitumen based, the tape has very strong adhesion and is waterproof, not becoming affected by damp. It can help maintain the waterproofing integrity of the plastic membrane.



It can be used to bond individual sheets together, providing a continuous, seamless waterproof seal.

Protecto-tape double sided bitumen tape is also available for securing sheets together or bonding the membrane to a dry structure.



## TECHNICAL DATA

PRODUCT	PROTECTO-DRAIN 8	PROTECTO-DRAIN 8 LIGHTWEIGHT	PROTECTO-DRAIN 68	PROTECTO-DRAIN 20	PROTECTO-DRAIN 20P	TEST METHOD
MATERIAL	HIGH DENSITY POLYETHYLENE (HDPE)					
FILTER MATERIAL			POLYPROPYLENE GEOTEXTILE (100GSM)			
COLOUR	BLACK					
MEMBRANE THICKNESS	0.6MM	0.50MM	0.6MM	0.9MM	0.9MM	CALIBRATED MEASURING TAPE
ROLL WIDTH	2 METRES	2 METRES	2 METRES	2 METRES	2 METRES	CALIBRATED MEASURING TAPE
ROLL LENGTH	20 METRES	20 METRES	20 METRES	20 METRES	20 METRES	CALIBRATED MEASURING TAPE
DENSITY	550 GSM (±10%)	450 GSM (±10%)	650 GSM (±10%)	1000 GSM (±10%)	1000 GSM (±10%)	CALIBRATED MEASURING TAPE
ROLLS PER PALLET	12	12	6	5	5	
COMPRESSION STRENGTH	180 KN PER M2	170 KN PER M2	250 KN PER M2	150 KN PER M <sup>2</sup>	150 KN PER M <sup>2</sup>	MDV
ELASTICITY	1595 KPA		2300 KPA	1100 KPA	1100 KPA	EN 25619-2
HEIGHT OF CUPS	8MM	8MM	8MM	20MM	20MM	MDV
NUMBER OF CUPS	1860 PIECES PER M2	1500 PIECES PER M2	1860 PIECES PER M2	400 DB/M <sup>2</sup>	400 DB/M <sup>2</sup>	MDV
WATER PERMEATIVITY			FILTER 100 LTR PER M2			
TENSILE STRENGTH MD			≥ 330 N / 50MM			EN 12311-2
TENSILE STRENGTH CMD			≥ 335 N / 50MM			EN 12311-2
ELONGATION MD			≥ 28.7 N			EN 12311-2
ELONGATION CMD			≥ 26.2 N			EN 12311-2
RESISTANCE TO IMPACT			≥ 410MM			EN 12691 & EN 13984
RESISTANCE TO TEARING MD			≥ 332 N			EN 12310
RESISTANCE TO TEARING CMD			≥ 349 N			EN 12310
RESISTANCE TO STATIC LOADING	NO PERFORATION AT 200 N IN 24 HRS					EN 12730
DURABILITY	MEMBRANE WATERPROOF / PASSED					EN 12691 & EN 13984
EXPOSURE TO LIQUID CHEMICALS	MEMBRANE WATERPROOF					EN 1847
AIR VOLUME BETWEEN THE CUPS	5.5 LITRES PER M2	5.5 LITRES PER M2	5.5 LITRES PER M2	14 LITRES PER M2	14 LITRES PER M2	MDV
WATER DRAINAGE CAPACITY	4.6 LITRES PER M2	4.6 LITRES PER M2	4.6 LITRES PER M2	10 LITRES PER M2	10 LITRES PER M2	MDV
TEMP TOLERANCE	- 40°C TO + 80°C					MDV
WARRANTY	ROT-PROOF FOR 20 YEARS					
REACTION TO FIRE	B2 (B1 AVAILABLE BY SPECIAL REQUEST)					DIN 4102
PHYSICAL CHARACTERISTICS	ROT-PROOF, RESISTANT TO FUNGUS AND BACTERIA. WILL NOT LEACH CHEMICALS. NOT HARMFUL TO DRINKING WATER. NO HEALTH HAZARDS UNDER NORMAL USE					
APPLICATION	<p>USED AS A MECHANICAL PROTECTION AGAINST SOIL AND ROOT MOVEMENT ALONG FOUNDATION WALLS. IT CAN BE INSTALLED WITH A 20CM OVERLAP AND FIXED WITH NAILS AND SEALING BUTTONS 5 CM FROM THE TOP EDGES OF THE ROLL AND 20CM FROM EACH ROLL. EDGING PROFILE IS INSTALLED TO PREVENT SOIL INGRESS INTO THE CAVITY. MAXIMUM BUILD-UP 8 METRES HIGH.</p> <p>LAI D HORIZONTALLY AND FIXED USING SEALING TAPE IN THE OVERLAPPING AREAS THE SHEETS PROTECT CONCRETE FLOORING FORM RISING DAMP AND KEEP REINFORCEMENT MESH IN PLACE FIRMLY DURING THE CONCRETE WORKS.</p>					
STORAGE & HANDLING	PROTECT AGAINST PROLONGED EXPOSURE TO DIRECT SUNLIGHT AND TEMPERATURES OVER 25 °C					
GUARANTEE / WARRANTY	WHEN USED IN THE CORRECT MANNER AND APPLICATION, THE MATERIAL WILL BE ROT PROOF FOR 20 YEARS. WALLBARN APPLICATION RULES AND PROPER SITE STORAGE, HANDLING AND INSTALLATION PRACTICES MUST BE CARRIED OUT AS A PREREQUISITE FOR ANY POSSIBLE FUTURE WARRANTY CLAIMS.					
HEALTH & SAFETY	NO KNOWN DANGEROUS SUBSTANCES. NO HEALTH HAZARDS UNDER NORMAL USE. NO LABELLING REQUIRED IN ACCORDANCE WITH THE RELEVANT REGULATION (EC) No. 1907/2006 OF THE EUROPEAN PARLIAMENT AND OF THE COUNCIL (REACH). SPECIFICATION UNDER EN 13967.					

This datasheet represents the current knowledge of the product, but may be revised by Wallbarn in the future. It is the duty of the customer and installer to be clear that this product is suitable for the purposes it is used for.

This technical datasheet may be revised or changed at any time without prior notice. It is the duty of the customer and installer to be sure they possess the latest version of the datasheet.



## PROTECTO-DRAIN DRAINAGE CHANNEL

Wallbarn's HDPE A15 drainage channel suitable for pedestrian and lightly trafficked areas.



It is designed to collect surface water off paved or asphalted areas and move that water away towards an underground drainpipe or escape route. The anti-slip, hardwearing galvanised steel grate maintains structural integrity across the area, so foot traffic and very light vehicles can pass over the drain without issue. Protecto-drain Drainage Channel is designed to be installed quickly and easily.

It has many applications including:

- domestic areas; such as driveways, gardens & patios
- public areas; such as pedestrian walkways, door thresholds, squares, recreational areas, schools, parks and playing fields

It simply slots in front of the building entrance or within the paved / asphalt area and provides an un-obstructed channel cross-section. Each individual channel clips together for fast and simple on-site fabrication. It is very easy to cut on areas where a part-metre length is required. All slots and measurement grooves run the whole way through the channel so side bars can also be installed into cut channels successfully.

### MEASUREMENT

Outer dimensions: 120mm high x 135mm wide

Inner dimensions: 90mm high x 100mm wide

### MATERIAL

Channel – High Density Polyethylene (HDPE)

Grate – galvanised steel

Classification - CE marked and fully certified to

Load Class - A15 BS EN 1433

Sustainability criteria - 100% recyclable



This 1 metre long fully assembled drainage channel has an integrated steel grid and the ingenious locking clip system, meaning it can be easily opened for inspection or cleaning.

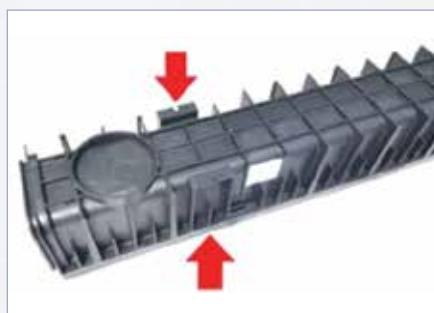



Multiple channels can be fitted together to create a much longer drainage channel. It is easy to cut when coming to the end of the stretch or where installing on angled lines.



An accessory pack for Protecto-drain Drainage Channel is also available. This includes the side bars to close the channel and a connecting bracket to fit to the underside of it, linking the channel to a drainpipe.

Complex plumbing is not required. If the channel needs to be linked to a plumbed-in option, the Ø110mm vertical outlet connector allows the unit to link directly to underground drainage pipework.



Simply knock the centre out of the moulded connecting bracket on the underside with a hammer and place the connector over the exposed circular hole with the screw holes in the connecting bracket aligned to the holes in the channel.

## TECHNICAL DATA

GENERAL PROPERTIES	TECHNICAL DATA	TEST METHOD
WIDTH OF CHANNEL (INSIDE/OUTSIDE)	100MM / 135MM	MANUFACTURER'S DECLARED VALUE
HEIGHT OF CHANNEL (INSIDE/OUTSIDE)	90MM / 120MM	MANUFACTURER'S DECLARED VALUE
FREE CROSS-SECTION OF THE CHANNEL	100 x 90 MM	MANUFACTURER'S DECLARED VALUE
LENGTH OF CHANNEL	1000 MM	MANUFACTURER'S DECLARED VALUE
UNIT WEIGHT OF CHANNEL	1,250 KG	MANUFACTURER'S DECLARED VALUE
WIDTH OF GRID	124 MM	MANUFACTURER'S DECLARED VALUE
HEIGHT OF GRID	20 MM	MANUFACTURER'S DECLARED VALUE
UNIT WEIGHT OF GRID	1.3 KG	MANUFACTURER'S DECLARED VALUE
CROSS SECTION OF OUTLET	Ø110 MM	MANUFACTURER'S DECLARED VALUE
LOAD CLASS	A 15 (15kN = 1500KG TESTLOAD)	EN 1433
STORAGE:	ON PALLETS UNDER DRY CONDITIONS, PROTECTED AGAINST ATMOSPHERIC EXPOSURE AND HEAT SOURCES.	
HEALTH & SAFETY:	NO LABELLING REQUIRED IN ACCORDANCE WITH THE RELEVANT REGULATION (EC) No. 1907/2006 OF THE EUROPEAN PARLIAMENT AND OF THE COUNCIL (REACH).	
SPECIFICATION:	EN 1433	
GUARANTEE:	IN ACCORDANCE WITH THE CURRENT LEGISLATION AND THE CONDITIONS OF THE DISTRIBUTOR. THE OBSERVATION OF THE APPLICATION RULES OF THE PRODUCT AND PRESENTATION OF THE INVOICE CONSTITUTE A PREREQUISITE FOR POSSIBLE FUTURE WARRANTY CLAIMS.	

This datasheet corresponds to our current knowledge, experiences and general information on the subject, but may be revised as new knowledge and / experience becomes available. It does not imply any legally binding assurance or obligation. The product possesses the given characteristics. Please refer to the LIMITED WARRANTY TERMS offered by Wallbarn Ltd. Since all variations of end usage of the product cannot be anticipated, it is the designer and end users' responsibility to ensure the suitability of this product for the particular purposes / installations.



## DRAINAGE OUTLETS, LEAF GUARDS, COLLARS & VENTS

WALLBARN PROVIDES A NUMBER OF PRODUCTS TO SEAL AND PROTECT DRAINAGE OUTLETS IN ROOFS, PARAPETS AND STRUCTURAL DECKS AND ENSURE WATERPROOF INTEGRITY, PREVENTING BLOCKAGES & DAMAGE TO THE DRAINAGE SYSTEM.

All flat roofs and podium decks require sufficient drainage outlets to prevent flooding. The areas immediately around these outlets are the most vulnerable parts of the waterproofing system and require strong, flexible and fully bonded membranes to prevent water getting beneath the waterproofing system.

Wallbarn has a number of products in a variety of materials to ensure that the deck structure is fully sealed:

- DOWN PIPE (circular) roof outlet drainage connectors seal and protect the area immediately around the down pipe drainage holes cast into the concrete



- THROUGH-WALL (parapet or corner) outlets are also bonded to the concrete deck or within the waterproofing membrane for horizontal drainage outlets



- LEAF GUARDS & GRAVEL EXCLUDERS are available for both down pipe and through-wall outlets to prevent blockages in the drainpipes



- COUPLINGS (drainpipe connectors) are available to fit the outlet to the HDPE drainpipe



- JUBILEE CLIPS for securing outlets and vents to pipework



- COLLARS will seal pipework emerging from the deck through the waterproofing



- VENTS & AERATORS to draw vapour from the concrete structure beneath



- REINFORCEMENT PATCHES for corners and edges





## MATERIAL COMPONENTS & COMPATIBILITY

Wallbarn supplies drainage outlets and connectors in a large range of shapes and sizes. These injection moulded units are manufactured in different materials meaning they are compatible with a variety of different waterproofing systems:

- TPE is a polypropylene / EPDM compound which is tough, flexible and durable and offers a cost effective solution. TPE outlets, collars and vents are compatible with bituminous membranes and can withstand contact with temperatures of 120°C, so they are ideal for use with membranes such as hot melt, torch-on felt or mastic asphalt. They are UV stable and will not become brittle in cold temperatures. TPE outlets and collars are available with a perforated flange / border surround designed to sandwich between two layers of liquid membrane, giving a very secure “over-and-under” bond. Solid flanges are also available for mechanical fixing or overlaying.
- EPDM drain connectors are extremely tough and very flexible and provide enhanced protection around the drainage hole. They are manufactured for both downpipes and through-wall outlets and are available with both a plain or perforated flange / border surround. They can also tolerate contact with very high temperatures so can also be used with hot melt, torch-on felts and mastic asphalt. They tolerate ultra-low temperatures also and have extremely good elasticity properties so will cope with structural movement very well.
- PVC outlets, vents and collars are manufactured in a soft and flexible type of PVC and are designed for use with PVC single ply membranes. They have a smooth flange / border surround and are designed to be welded to the waterproofing membrane so they cope very well with hot temperatures

## MEASURING DRAINAGE OUTLETS / CONNECTORS

It is essential that the correct size of drainage connector is chosen as obviously the spigot will need to fit into the drainage hole but it should not be so loose that it potentially causes movement over time, which could make the seal unstable. The spigot is tapered to make it easier to press into the drainage hole.

### DOWNPIPE

H height of the spigot or shank

D1 outer diameter of the flange / border surround

D2 inner diameter of the pipe at the top

D3 inner diameter of the pipe at the bottom

D4 outer diameter of the pipe at the top **which needs to be smaller than the inner diameter of the HDPE drainpipe**

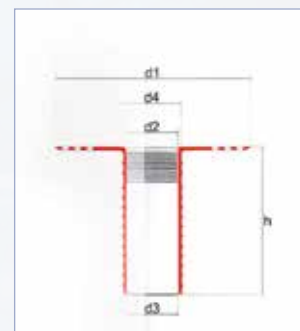

### THROUGH-WALL (CIRCULAR SPIGOT)

D1 diameter of the outlet drainage hole

D2 height of the (recessed) outlet drainage hole

D3 inner diameter of the spigot at the bottom

L inner length of spigot

F1 width of the flange around the underside of the outlet hole

F2 height of the flange to the left and right, and above the outlet hole

F3 width of the flange across the face

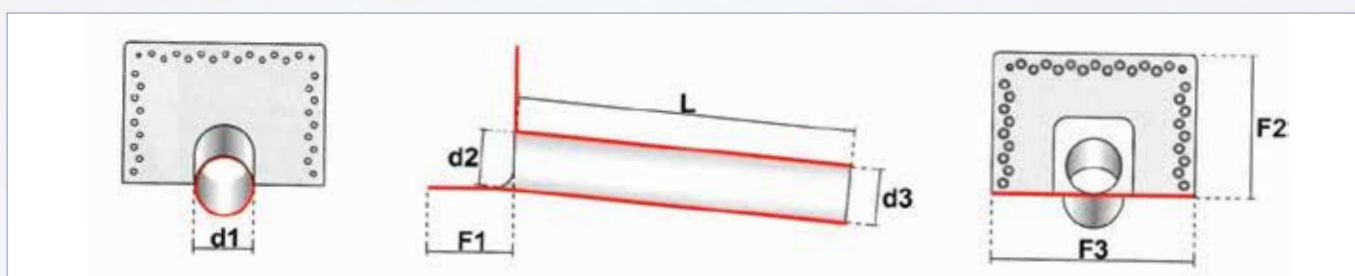

### THROUGH-WALL (RECTANGULAR SPIGOT)

A height of the outlet drainage hole

B width of the outlet drainage hole

L inner length of the shank or outlet pipe

F1 width of the flange in front of the outlet hole

F2 height of the border flap or flange above the outlet hole

F3 width of the flange across the face

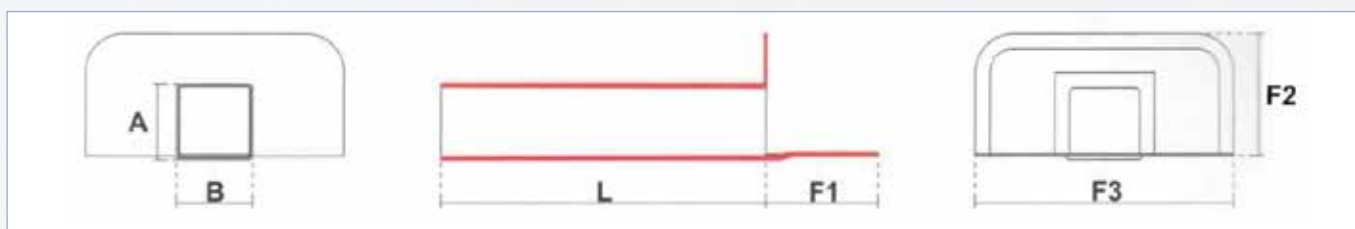

## TPE DOWNPIPE CONNECTORS

### DOWNPIPE CONNECTORS WITH PERFORATED FLANGE

The downpipe drain connector is used on flat roofs and podiums to reinforce the circular drainage holes cast at intervals in a concrete deck. These drainage holes are typically cast every 25m<sup>2</sup> apart.

They are designed to be sandwiched between two layers of waterproofing. The first layer of waterproofing is installed then while it is still tacky the outlet is inserted into the hole. The perforated flange allows the membrane to ooze through to bond to itself, ensuring a very secure bond.



The outlet / connector should not come into direct contact with the bare concrete, as this risks the chance of water passing beneath.



A second coat / layer of liquid membrane, or a patch of membrane in the case of torch-on-felt is installed on top of the flange to create an “over-and-under” bond so the outlet is bonded securely within the waterproofing membrane.

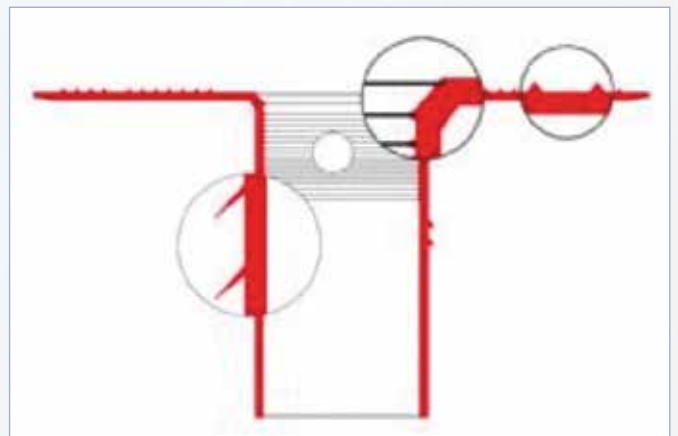
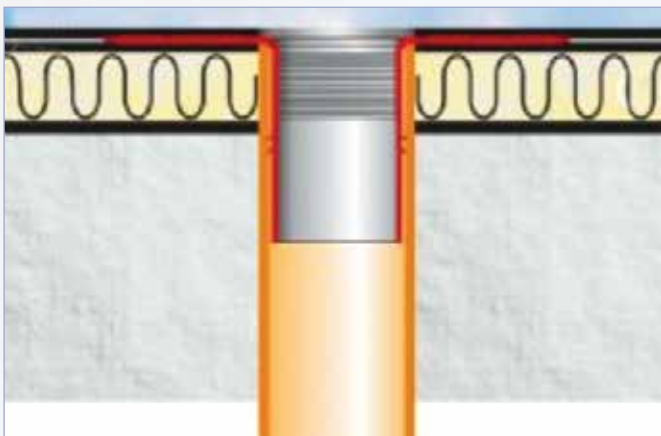

At the mouth of the spigot there are a series of ribs and serrations along the inside, which ensure a leaf guard or gravel-excluder can be fitted into the connector securely.

### NON-PERFORATED CIRCULAR OUTLETS IN TPE

Wallbarn also offers a range of non-perforated circular outlets in TPE, but these will not offer the “over-and-under” bond provided for by the perforated range.

The flange is ribbed to help adhere to the membrane and can offer a slightly more cost effective alternative.





## TPE DOWNPIPE OUTLETS - CODES

### DOWNPIPE

H height of the spigot or shank • D1 outer diameter of the flange / border surround  
 D2 inner diameter of the pipe at the top • D3 inner diameter of the pipe at the bottom  
 D4 outer diameter of the pipe at the top

The size marked on the actual units denotes the measurement these units will fit into, so they are actually slightly smaller than the number marked.

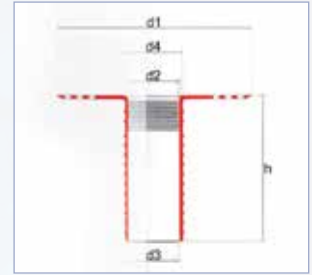

### PERFORATED FLANGE

CODE	DESCRIPTION	D1 (MM)	D2 (MM)	D3 (MM)	D4 (MM)	H (MM)
RD-TPE-030-050-240-040	TPE CIRCULAR ROOF OUTLET (PERFORATED FLANGE) H240MM - D40MM	235	26	24	31	240
RD-TPE-030-050-240-060	TPE CIRCULAR ROOF OUTLET (PERFORATED FLANGE) H240MM - D60MM	235	48	43	53	240
RD-TPE-030-050-240-075	TPE CIRCULAR ROOF OUTLET (PERFORATED FLANGE) H240MM - D75MM	320	65	61	70	240
RD-TPE-030-050-240-080	TPE CIRCULAR ROOF OUTLET (PERFORATED FLANGE) H240MM - D80MM	320	69	64	74	240
RD-TPE-030-050-240-090	TPE CIRCULAR ROOF OUTLET (PERFORATED FLANGE) H240MM - D90MM	320	77	73	82	240
RD-TPE-030-050-240-100	TPE CIRCULAR ROOF OUTLET (PERFORATED FLANGE) H240MM - D100MM	320	89	84	94	240
RD-TPE-030-050-240-110	TPE CIRCULAR ROOF OUTLET (PERFORATED FLANGE) H240MM - D110MM	320	91	87	96	240
RD-TPE-030-050-240-125	TPE CIRCULAR ROOF OUTLET (PERFORATED FLANGE) H240MM - D125MM	320	114	109	119	240
RD-TPE-030-050-240-140	TPE CIRCULAR ROOF OUTLET (PERFORATED FLANGE) H240MM - D140MM	380	127	122	132	240
RD-TPE-030-050-240-150	TPE CIRCULAR ROOF OUTLET (PERFORATED FLANGE) H240MM - D150MM	380	136	131	141	240
RD-TPE-030-050-240-160	TPE CIRCULAR ROOF OUTLET (PERFORATED FLANGE) H240MM - D160MM	380	146	141	151	240
RD-TPE-030-050-240-200	TPE CIRCULAR ROOF OUTLET (PERFORATED FLANGE) H240MM-D200MM	440	185	180	190	240



### PERFORATED FLANGE WITH EXTRA LONG SPIGOT

RD-TPE-030-160-600-080	TPE EXTRA LONG CIRC.OUTLET (PERFORATED FLANGE) H600MM-D80MM	370	65	63	72	600
RD-TPE-030-160-600-090	TPE EXTRA LONG CIRC.OUTLET (PERFORATED FLANGE) H600MM-D90MM	370	74	72	81	600
RD-TPE-030-160-600-100	TPE EXTRA LONG CIRC.OUTLET (PERFORATED FLANGE) H600MM-D100MM	370	85	83	92	600
RD-TPE-030-160-600-110	TPE EXTRA LONG CIRC.OUTLET (PERFORATED FLANGE) H600MM-D110MM	390	93	91	100	600
RD-TPE-030-160-600-125	TPE EXTRA LONG CIRC.OUTLET (PERFORATED FLANGE) H600MM-D125MM	390	107	105	114	600
RD-TPE-030-160-600-140	TPE EXTRA LONG CIRC.OUTLET (PERFORATED FLANGE) H600MM-D140MM	420	125	123	132	600
RD-TPE-030-160-600-150	TPE EXTRA LONG CIRC.OUTLET (PERFORATED FLANGE) H600MM-D150MM	420	135	133	142	600
RD-TPE-030-160-600-160	TPE EXTRA LONG CIRC.OUTLET (PERFORATED FLANGE) H600MM-D160MM	420	138	136	145	600
RD-TPE-030-160-600-200	TPE EXTRA LONG CIRC.OUTLET (PERFORATED FLANGE) H600MM-D200MM	460	178	176	185	600

### NON PERFORATED FLANGE

RD-TPE-030-040-240-040	TPE CIRCULAR ROOF OUTLET (RIBBED FLANGE) H240MM - D40MM	235	26	24	31	240
RD-TPE-030-040-240-060	TPE CIRCULAR ROOF OUTLET (RIBBED FLANGE) H240MM - D60MM	235	48	43	53	240
RD-TPE-030-040-240-075	TPE CIRCULAR ROOF OUTLET (RIBBED FLANGE) H240MM - D75MM	320	65	61	70	240
RD-TPE-030-040-240-080	TPE CIRCULAR ROOF OUTLET (RIBBED FLANGE) H240MM - D80MM	320	69	64	74	240
RD-TPE-030-040-240-090	TPE CIRCULAR ROOF OUTLET (RIBBED FLANGE) H240MM - D90MM	320	77	73	82	240
RD-TPE-030-040-240-100	TPE CIRCULAR ROOF OUTLET (RIBBED FLANGE) H240MM - D100MM	320	89	84	94	240
RD-TPE-030-040-240-110	TPE CIRCULAR ROOF OUTLET (RIBBED FLANGE) H240MM - D110MM	320	91	87	96	240
RD-TPE-030-040-240-125	TPE CIRCULAR ROOF OUTLET (RIBBED FLANGE) H240MM - D125MM	320	114	109	119	240

N.B. SPIGOT LENGTH CAN BE INCREASED USING THE EXTENSION SHANKS. COUPLINGS ARE SUPPLIED TO CONNECT TO DRAINPIPES AND JUBILEE CLIPS ARE ALSO AVAILABLE. PLEASE SEE PAGES 134 & 136 FOR MORE DETAILS.

## TPE THROUGH-WALL OUTLETS / FITTINGS

### THROUGH WALL WITH PERFORATED FLANGE

It is essential that the area around the drainage holes has a dedicated reinforced detail guarding the drainage hole.

In the same way that the downpipe outlet is connected, the TPE through-wall connector is installed in a sandwich manner, bonded between two layers of bituminous waterproofing membrane.

The TPE material can tolerate the application of hot liquid or even a torch-gun coming into contact with it.

### INSTALLATION IS AS FOLLOWS:

The outlet is installed between two layers of bituminous felt. A patch of felt is bonded to the deck and the upper side of the patch is also torch-heated so that the bitumen becomes tacky on the upper side.



The outlet is then placed on top of the patch when the bitumen is still tacky and pressed into it firmly. Some of the bitumen oozes through the perforations.

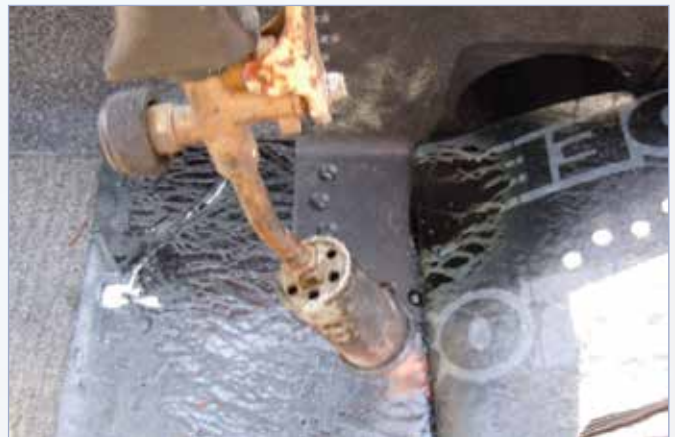

A second layer of felt is installed immediately on top of the flange (and the patch beneath it) whilst the bitumen is still tacky and is torch-heated so that the bitumen on this upper layer melts slightly. The two layers of felt adhere to each other, encapsulating the outlet.



N.B. SPIGOT LENGTH CAN BE INCREASED USING THE EXTENSION SHANKS. COUPLINGS ARE SUPPLIED TO CONNECT TO DRAINPIPES AND JUBILEE CLIPS ARE ALSO AVAILABLE. PLEASE SEE PAGES 134 & 136 FOR MORE DETAILS.



The spigot connects to the HDPE drain pipe by slotting inside it. It is slightly tapered so that it can fit easily into the pipe. By being inside the drainage hole there is no risk of water creeping behind it and causing a leak.

It is rounded in shape and slightly recessed to encourage the water to flow into the pipe immediately and not pond around the mouth.

The spigot is slightly angled to help create a fall from the deck into the hole, encouraging faster flow of the water down the pipe. The spigot itself is 500mm long, so it can cross through a large section of wall. Extension shanks are available to create a longer spigot if required for very thick walls.

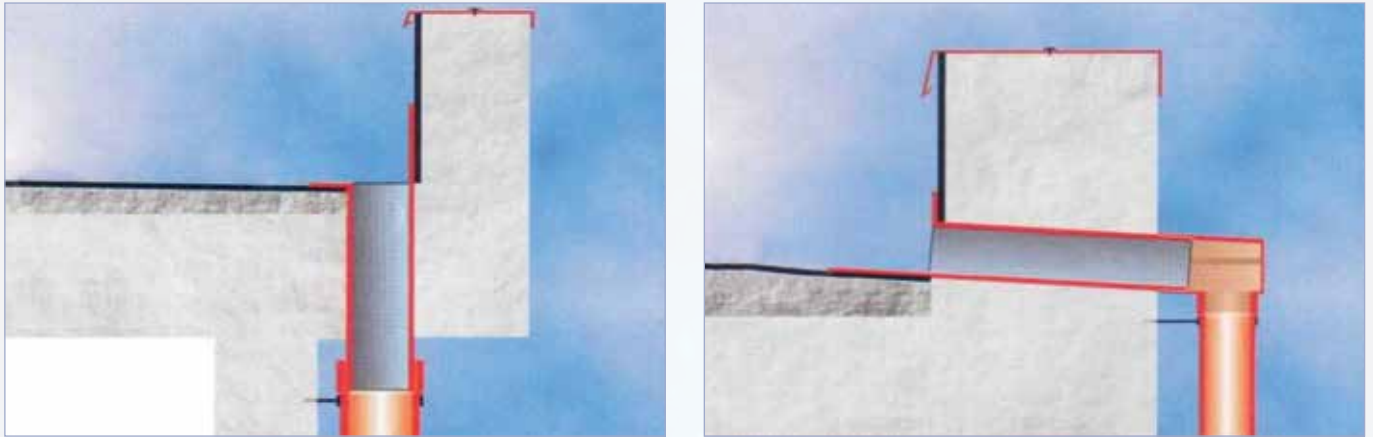

These through-wall units can be fitted to both vertical downpipes at the edge of the retaining wall, or on a horizontal plane through the upstand or wall to connect to the external downpipe.

**THEY ARE MEASURED AS FOLLOWS:**

D1 diameter of the outlet drainage hole

D2 height of the (recessed) outlet drainage hole

D3 inner diameter of the spigot at the bottom

L inner length of spigot

F1 width of the flange around the underside of the outlet hole

F2 height of the flange to the left and right, and above the outlet hole

F3 width of the flange across the face

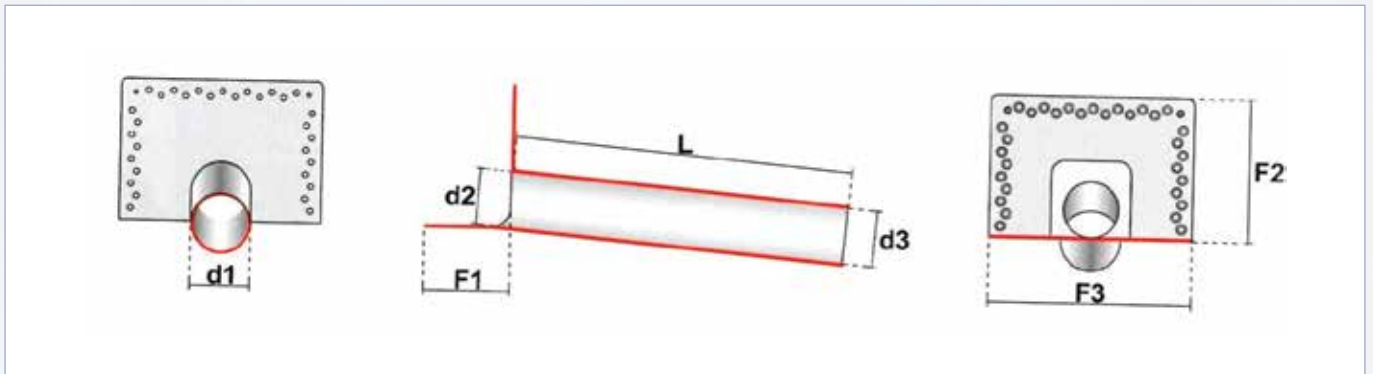

CODE	DESCRIPTION	D1 (MM)	D2 (MM)	D3 (MM)	L (MM)	F1 (MM)	F2 (MM)	F3 (MM)
RD-TPE-030-360-500-050	TPE CORNER ROOF OUTLET (PERFORATED FLANGE) - L500MM-D50MM	50	43	44	500	110	140	260
RD-TPE-030-360-500-063	TPE CORNER ROOF OUTLET (PERFORATED FLANGE) - L500MM-D63MM	63	56	57	500	130	175	304
RD-TPE-030-360-500-075	TPE CORNER ROOF OUTLET (PERFORATED FLANGE) - L500MM-D75MM	75	68	69	500	130	175	304
RD-TPE-030-360-500-080	TPE CORNER ROOF OUTLET (PERFORATED FLANGE) - L500MM-D80MM	80	74	76	500	130	175	304
RD-TPE-030-360-500-090	TPE CORNER ROOF OUTLET (PERFORATED FLANGE) - L500MM-D90MM	90	83	84	500	130	215	304
RD-TPE-030-360-500-100	TPE CORNER ROOF OUTLET (PERFORATED FLANGE) - L500MM-D100MM	100	94	96	500	130	215	304
RD-TPE-030-360-500-110	TPE CORNER ROOF OUTLET (PERFORATED FLANGE) - L500MM-D110MM	110	103	104	500	130	215	304
RD-TPE-030-360-500-125	TPE CORNER ROOF OUTLET (PERFORATED FLANGE) - L500MM-D125MM	125	118	119	500	130	260	360

N.B. SPIGOT LENGTH CAN BE INCREASED USING THE EXTENSION SHANKS. COUPLINGS ARE SUPPLIED TO CONNECT TO DRAINPIPES AND JUBILEE CLIPS ARE ALSO AVAILABLE. PLEASE SEE PAGES 134 & 136 FOR MORE DETAILS.

## THROUGH-WALL OUTLET FITTINGS WITH RECTANGULAR MOUTH

These TPE through-wall fittings are an alternative design and manufactured with a ribbed rather than perforated profile across the whole flange / border. They have a square or rectangular opening at the mouth of the pipe rather than the rounded hole as with the perforated range.



There are two types available, the right angled mouth and an outlet with a 45° angle at the mouth.



Acting in the same way as a fillet in the junction between wall and floor, this angle pulls the water coming down the wall away from the corner and directs it into the mouth of the spigot more effectively.

These outlets can also be installed using the sandwich method; so that one coat of waterproofing membrane (or one layer of felt / adhesive) is laid onto the bare concrete. The outlet is positioned and the second coat of adhesive / membrane is laid on top. The liquid will spread into the grooves and grip the outlet surround, also bonding to the other coat of membrane around the edges of the unit. This ensures a proper, secure fit.

To improve adhesion, the connector and the surrounding concrete should be prepared with a coat of primer.

These through-wall fittings are suitable for both horizontal and vertical drains.

### THEY ARE MEASURED AS FOLLOWS:

A height of the outlet drainage hole

B width of the outlet drainage hole

L inner length of the shank or outlet pipe

F1 width of the flange in front of the outlet hole

F2 height of the border flap or flange above the outlet hole

F3 width of the flange across the face



CODE	DESCRIPTION	A (MM)	B (MM)	L (MM)	F1 (MM)	F2 (MM)	F3 (MM)
RD-TPE-030-300-065-100	TPE SQUARE CORNER OUTLET RIGHT ANGLE RIBBED FLANGE 65X100MM	65	100	425	150	160	340
RD-TPE-030-300-100-100	TPE SQUARE CORNER OUTLET RIGHT ANGLE RIBBED FLANGE 100X100MM	100	100	425	150	160	340
RD-TPE-030-301-065-100	TPE SQUARE CORNER OUTLET 45 DEGREE RIBBED FLANGE 65MMX100MM	65	100	425	150	160	340
RD-TPE-030-301-100-100	TPE SQUARE CORNER OUTLET 45 DEGREE RIBBED FLANGE 100MMX100MM	100	100	425	150	160	340



## PIPE COLLARS IN TPE

These collars are designed to surround pipe work such as bad odour vents and stand pipes.

It is critical that these pipes are completely waterproofed as they emerge from the deck since water ingress will flow directly into an interior section of the building, such as a bathroom.

Collars will fit around the outside of an HDPE pipe (as opposed to the connectors and outlets which slot into the inside of a standard drain pipe) and completely seal the junction between the hole and the pipe.

They are manufactured in a slightly conical shape, so they are easy to fit.



It is essential that the correct size of collar is chosen, as it needs to fit snugly around the pipe and without too much of a gap which might become loose over time.

The TPE collars are manufactured with a perforated flange so that they can be installed in the same sandwich method as the drainage outlet connectors.

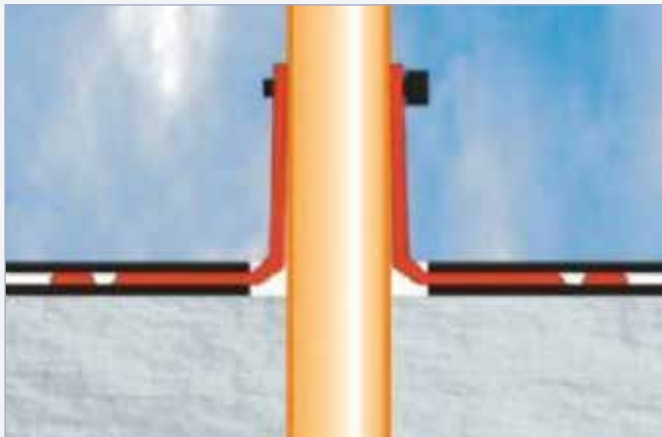

The collars can be secured using a Jubilee clip – please see page XXXX in our accessories section for more details.

### THEY ARE MEASURED AS FOLLOWS:

H is the height of the collar

D1 is the outer diameter of the flange

D2 is the inner diameter of the collar at the bottom

D3 is the inner diameter of the pipe at the top

**which needs to be smaller than the inner diameter of the HDPE drainpipe**

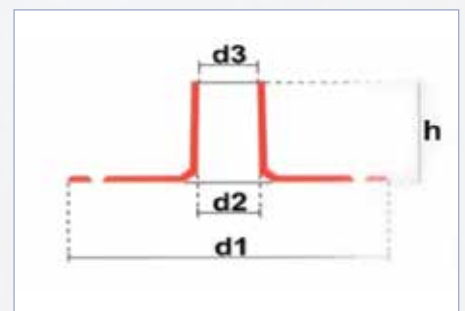

CODE	DESCRIPTION	D1 (MM)	D2 (MM)	D3 (MM)	H (MM)
RO-TPE-030-380-060-030	TPE COLLAR (PERFORATED FLANGE) - H60MM - D30MM	154	32	30	60
RO-TPE-030-380-060-040	TPE COLLAR (PERFORATED FLANGE) - H60MM - D40MM	154	42	40	60
RO-TPE-030-380-060-060	TPE COLLAR (PERFORATED FLANGE) - H60MM - D60MM	194	62	60	60
RO-TPE-030-380-060-080	TPE COLLAR (PERFORATED FLANGE) - H60MM - D80MM	194	82	80	60
RO-TPE-030-380-090-100	TPE COLLAR (PERFORATED FLANGE) - H90MM - D100MM	234	102	100	60
RO-TPE-030-380-090-120	TPE COLLAR (PERFORATED FLANGE) - H90MM - D120MM	234	122	120	60
RO-TPE-030-380-090-140	TPE COLLAR (PERFORATED FLANGE) - H90MM - D140MM	274	142	140	60
RO-TPE-030-380-090-160	TPE COLLAR (PERFORATED FLANGE) - H90MM - D160MM	274	162	160	60

## VENTS & AERATORS IN TPE

Concrete will retain an element of moisture after the construction process and vents are required on the roof once it is waterproofed. If not, retained moisture can build up pressure points beneath the waterproofing membrane causing it to bulge and blister. Wallbarr recommends a vent is placed at least every 25m<sup>2</sup>.

The vent is placed directly onto the bare concrete beneath the waterproofing membrane and insulation. The underside of the flange will be in direct contact with the concrete. There are a series of ribs along the underside of the round base plate (or flange) which helps to draw vapour into the tube (or flue) in the centre of the vent.

The waterproofing membrane will then be applied over the base of the vent.



The top of the tube or flue has three holes to allow the vapour to escape into the atmosphere. It is covered by a hood or cap which overlaps the internal holes, preventing rainwater entering the system but still allowing the passage of vapour.

Being TPE, the vent can be bonded to liquid bituminous membranes or suitable adhesives. The membrane will be installed across the top of the flange, and the grooved upper surface of the base plate / flange helps give a secure bond.

Wallbarr can supply three types of vent. The standard vent has a flue of 240mm high and 75mm in diameter.

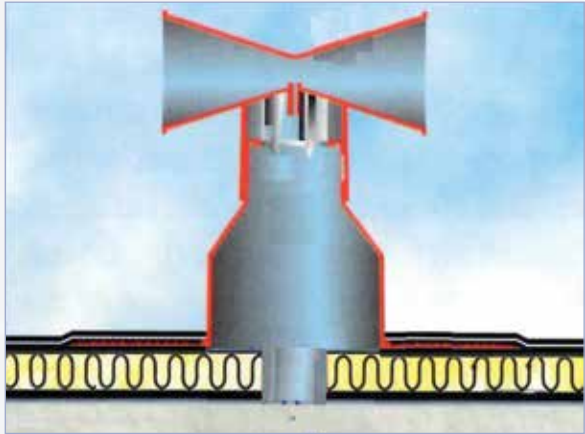

A shorter, broader vent can also be produced for decks where a shorter pipe is required. An extra-long vent pipe, at 400mm high, is also available.

### THEY ARE MEASURED AS FOLLOWS:

- H is the height of the pipe
- D1 is the diameter of the base plate / flange
- D2 is the diameter of the flue or pipe at the bottom of the vent
- D3 is the diameter of the flue or pipe at the top (where it meets the cap / hood)

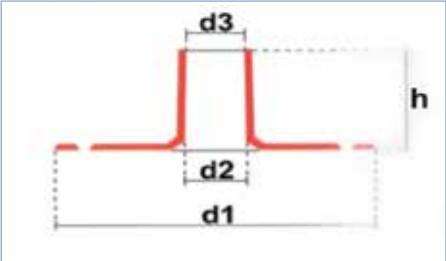

CODE	DESCRIPTION	D1 (MM)	D2 (MM)	D3 (MM)	H (MM)
RO-TPE-030-420-240-075	TPE VENT/ AERATOR (RIBBED FLANGE) - H240MM - D75MM	320	76	73	240
RO-TPE-030-460-160-125	TPE VENT/ AERATOR (RIBBED FLANGE) - H160MM - D125MM	390	125	73	160
RO-TPE-030-460-400-125	TPE VENT/ AERATOR (RIBBED FLANGE) - H400MM - D125MM	390	125	73	400
RO-TPE-030-500-100-065	TPE DOUBLE AERATOR (RIBBED FLANGE) - BOTTOM - H100MM -D320MM	320	67	64	100
RO-TPE-030-500-220-065	TPE DOUBLE AERATOR (RIBBED FLANGE) - TOP - H220MM - D320MM	320	67	64	220



## SPECIAL DOUBLE AERATOR – FOR INSULATED ROOFS

The double aerator comprises of two vents, for areas where both the concrete deck and the insulation need to be ventilated. Here a “special” 100mm high vent is placed onto the bare concrete beneath the waterproofing, and beneath the insulation; and another standard aerator is placed on top of the insulation.

They will be bonded beneath the waterproofing membrane so that the underside of the flange is in direct contact with the concrete or the insulation board. This maximises the amount of draw from the structure. It is important to order both of these products together and also order an appropriate hood or cap for the top vent.

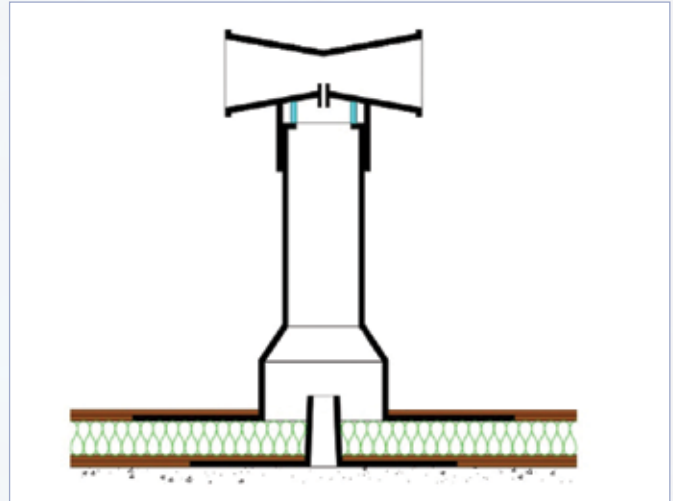

### THEY ARE MEASURED AS FOLLOWS:

H is the height of the pipe

D1 is the diameter of the base plate / flange

D2 is the diameter of the flue or pipe at the bottom of the vent

D3 is the diameter of the flue or pipe at the top (where it meets the cap / hood)

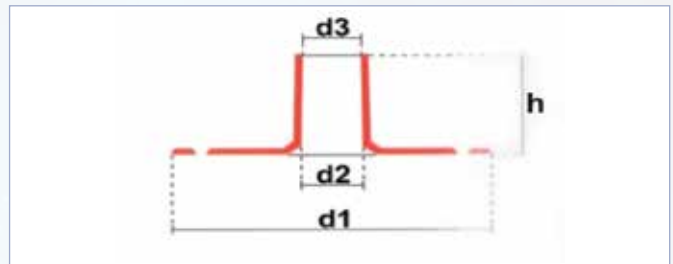

CODE	DESCRIPTION	D1 (MM)	D2 (MM)	D3 (MM)	H (MM)
RO-TPE-030-500-100-065	TPE DOUBLE AERATOR (RIBBED FLANGE) - BOTTOM - H100MM -D320MM	320	67	64	100
RO-TPE-030-500-220-065	TPE DOUBLE AERATOR (RIBBED FLANGE) - TOP - H220MM - D320MM	320	67	64	220

All these vents are UV stable and resistant to the elements. They are designed to be extremely tough and durable, and are guaranteed to last for at least 15 years.

## CAPS FOR VENTS

There are two designs of hood / flue – a standard round cap; and a special ESTRAER® funnel shaped hood.

The ESTRAER® aerator hood is cone-shaped and designed to increase the amount of moisture sucked out of the concrete. It is tough and durable, but very easy to fit.

The ESTRAER® cap is clicked onto the shaft of the vent and the two cone shaped trunks are positioned so that they face the prevailing wind direction.

There is a small cylinder on the inside of the head which acts as a suction chamber and helps to draw vapour into the funnels.

The cones can be fitted onto all the different sizes and types of vent shaft available, and are suitable for both TPE and PVC vents. They should be ordered at the same time as the vent shaft.



### ESTRAER® CAP MEASUREMENTS:

H overall height of the cap including funnels

D1 diameter of cap at the bottom (where it slots onto pipe)

D2 diameter of the funnels at each side

### STANDARD CAP MEASUREMENTS:

H is the overall height of the cap

D1 diameter of cap at the bottom (where it slots onto pipe)

D2 diameter at the top

CODE	DESCRIPTION	D1 (MM)	D2 (MM)	H (MM)
RO-TPE-030-500-900-010	TPE SPECIAL ESTRAER CAP FOR VENT	75	82	140
RO-TPE-030-500-900-080	TPE STANDARD CAP FOR VENT	108	110	82

## DRAINAGE CONNECTORS AND OUTLETS IN EPDM

EPDM drain connectors provide a very tough and durable seal around outlet drainage holes. The material is suitable for bituminous and EPDM waterproofing membranes and can be mechanically fitted or bonded in the sandwich technique.

The EPDM material remains extremely flexible even at low temperatures, and will tolerate 120°C, so it is ideal for being applied in hot melt membranes. The material is UV stable, and resistant to ozone and other atmospheric chemicals. It can tolerate movement in the structure without risk of splitting.

### EPDM DOWNPIPE CONNECTORS

#### DOWNPIPE CONNECTORS WITH PERFORATED FLANGE

The EPDM perforated flange downpipe outlet is designed to be sandwiched between two layers of waterproofing membrane. Again, the outer ring or flange is perforated, so that the liquid membrane can ooze through the holes and provide an over-and-under bond. This ensures it is fully watertight.

The inside of the mouth of the spigot has ridges so a gravel guard or leaf excluder can be fitted. The spigot is tapered and has a series of ribs going the whole way down to improve the fit inside the drainpipe.

The spigot is 250mm long and is inserted down inside of the HDPE drainpipe. This gives ample assurance that no water can back up behind the rubber and onto the deck.



### EPDM DRAIN CONNECTOR WITH ANTI-SMELL SIPHON

When constructing high end roof terraces, leisure areas or public walkways, designers and users do not want to have to contend with bad odours coming up from hidden drain pipes.

Wallbarn can supply a variation on the design of the standard drain connector in EPDM which incorporates the perforated flange and spigot, but also contains a siphon mechanism to help eliminate bad smells and odours emitting from the drainpipe up to the roof or deck.

As water drains off the roof it will fall into a well-type holding basin, effectively sealing the drainpipe. Only when a larger amount of water flows in will the water level rise above the internal lips and run down into the shaft and into the HDPE drainpipe. It works in a similar way to a U bend.

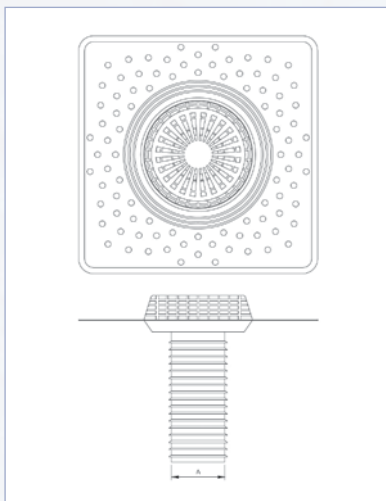

N.B. SPIGOT LENGTH CAN BE INCREASED USING THE EXTENSION SHANKS. COUPLINGS ARE SUPPLIED TO CONNECT TO DRAINPIPES AND JUBILEE CLIPS ARE ALSO AVAILABLE. PLEASE SEE PAGES 134 & 136 FOR MORE DETAILS.



## DOWNPIPE CONNECTORS WITH SMOOTH FLANGE FOR MECHANICAL FIXING

The EPDM downpipe connector is also manufactured with a smooth flange and is ideal for mechanical fixing.



Waterproof the area around the drainage hole. Insert the correct size of outlet connector into the hole so that it is covering the waterproofing membrane. Secure the connector either by using fixings or adhesive.

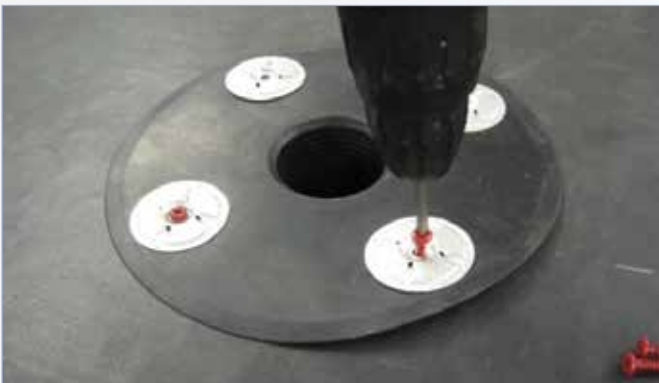

Prime the area and install another layer of waterproofing membrane, laid across the face of the outlet connector so that it is encapsulated in a "sandwich".



Once the membrane / adhesive is cured a hole may need to be cut to reveal the drain pipe, and a leaf guard or gravel excluder is inserted into the hole. The outlet is then finished.

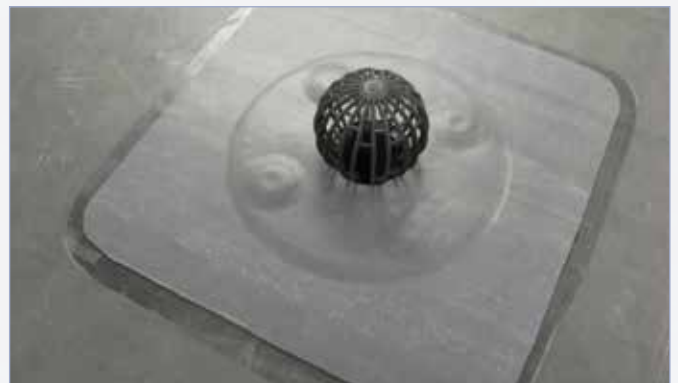

N.B. SPIGOT LENGTH CAN BE INCREASED USING THE EXTENSION SHANKS. COUPLINGS ARE SUPPLIED TO CONNECT TO DRAINPIPES AND JUBILEE CLIPS ARE ALSO AVAILABLE. PLEASE SEE PAGES 134 & 136 FOR MORE DETAILS.

## EDPM DOWNPIPE OUTLETS - CODES

### DOWNPIPE

H height of the spigot or shank

D1 outer diameter of the flange / border surround

D2 inner diameter of the pipe at the top

D3 inner diameter of the pipe at the bottom

D4 outer diameter of the pipe at the top

The size marked on the actual units denotes the measurement these units will fit into, so they are actually slightly smaller than the number marked.

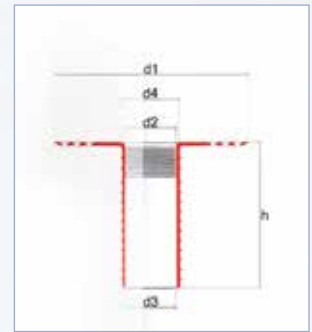

### EPDM DOWNPIPE WITH PERFORATED FLANGE

CODE	DESCRIPTION	D1 (MM)	D2 (MM)	D3 (MM)	D4 (MM)	H (MM)
RO-EPDM-095-050-250-040	EPDM CIRCULAR ROOF OUTLET (PERFORATED FLANGE) - H250MM-D40MM	248	28	25	34	250
RO-EPDM-095-050-250-050	EPDM CIRCULAR ROOF OUTLET (PERFORATED FLANGE) - H250MM-D50MM	258	38	35	44	250
RO-EPDM-095-050-250-060	EPDM CIRCULAR ROOF OUTLET (PERFORATED FLANGE) - H250MM-D60MM	271	51	48	57	250
RO-EPDM-095-050-250-075	EPDM CIRCULAR ROOF OUTLET (PERFORATED FLANGE) - H250MM-D75MM	283	63	60	69	250
RO-EPDM-095-050-250-080	EPDM CIRCULAR ROOF OUTLET (PERFORATED FLANGE) - H250MM-D80MM	332	68	65	74	250
RO-EPDM-095-050-250-090	EPDM CIRCULAR ROOF OUTLET (PERFORATED FLANGE) - H250MM-D90MM	332	77	74	83	250
RO-EPDM-095-050-250-100	EPDM CIRCULAR ROOF OUTLET (PERFORATED FLANGE)- H250MM-D100MM	332	88	85	94	250
RO-EPDM-095-050-250-110	EPDM CIRCULAR ROOF OUTLET (PERFORATED FLANGE)-H250MM-D110MM	332	98	95	104	250
RO-EPDM-095-050-250-125	EPDM CIRCULAR ROOF OUTLET (PERFORATED FLANGE)-H250MM-D125MM	332	113	110	119	250
RO-EPDM-095-050-250-140	EPDM CIRCULAR ROOF OUTLET (PERFORATED FLANGE)-H250MM-D140MM	347	128	125	134	250
RO-EPDM-095-050-250-160	EPDM CIRCULAR ROOF OUTLET (PERFORATED FLANGE)-H250MM-D160MM	367	148	145	154	250
RO-EPDM-095-050-250-200	EPDM CIRCULAR ROOF OUTLET (PERFORATED FLANGE)-H250MM-D200MM	406	186	183	192	250

### EPDM DOWNPIPE NON PERFORATED FLANGE

CODE	DESCRIPTION	D1 (MM)	D2 (MM)	D3 (MM)	D4 (MM)	H (MM)
RO-EPDM-090-040-240-040	EPDM CIRCULAR ROOF OUTLET (SMOOTH FLANGE) - H240MM - D40MM	235	26	24	31	240
RO-EPDM-090-040-240-060	EPDM CIRCULAR ROOF OUTLET (SMOOTH FLANGE) - H240MM - D60MM	235	48	43	53	240
RO-EPDM-090-040-240-075	EPDM CIRCULAR ROOF OUTLET (SMOOTH FLANGE) - H240MM - D75MM	320	65	61	70	240
RO-EPDM-090-040-240-080	EPDM CIRCULAR ROOF OUTLET (SMOOTH FLANGE) - H240MM - H80MM	320	69	64	74	240
RO-EPDM-090-040-240-090	EPDM CIRCULAR ROOF OUTLET (SMOOTH FLANGE) - H240MM - D90MM	320	77	73	82	240
RO-EPDM-090-040-240-100	EPDM CIRCULAR ROOF OUTLET (SMOOTH FLANGE) - H240MM - D100MM	320	85	80	90	240
RO-EPDM-090-040-240-110	EPDM CIRCULAR ROOF OUTLET (SMOOTH FLANGE) - H240MM - D110MM	320	91	87	96	240
RO-EPDM-090-040-240-125	EPDM CIRCULAR ROOF OUTLET (SMOOTH FLANGE) - H240MM - D125MM	320	111	106	116	240
RO-EPDM-090-040-240-140	EPDM CIRCULAR ROOF OUTLET (SMOOTH FLANGE) - H240MM - D140MM	380	127	122	132	240
RO-EPDM-090-040-240-150	EPDM CIRCULAR ROOF OUTLET (SMOOTH FLANGE) - H240MM - D150MM	380	136	131	141	240
RO-EPDM-090-040-240-160	EPDM CIRCULAR ROOF OUTLET (SMOOTH FLANGE) - H240MM - D160MM	380	146	141	151	240
RO-EPDM-090-040-240-200	EPDM CIRCULAR ROOF OUTLET (SMOOTH FLANGE) - H240MM - D200MM	380	185	180	190	240

### EPDM SIPHON DOWNPIPE - PERFORATED FLANGE

#### THEY ARE MEASURED AS FOLLOWS:

H height of the spigot or pipe

H1 height of the well – where the water will collect to and the excess flow into the pipe

D1 outer diameter of the flange or surrounding ring

D2 inner diameter of the pipe at the top

D3 inner diameter of the pipe at the bottom

D4 outer diameter of the well at the top and also the outer diameter of the leaf guard

D5 outer diameter pipe at the top

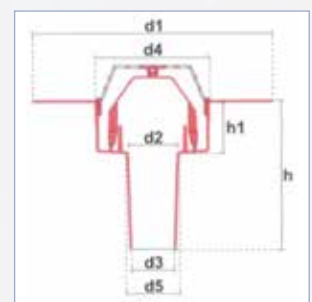

CODE	DESCRIPTION	D1 (MM)	D2 (MM)	D3 (MM)	D4 (MM)	D5 (MM)	H (MM)	H1 (MM)
RO-EPDM-095-150-250-080	EPDM "SIPHON" ROOF OUTLET (PERFORATED FLANGE) - H250MM - D80MM	360	73	64	172	78	250	76
RO-EPDM-095-150-250-100	EPDM "SIPHON" ROOF OUTLET (PERFORATED FLANGE) H250MM - D100MM	360	92	83	172	97	250	76
RO-EPDM-095-150-250-110	EPDM "SIPHON" ROOF OUTLET (PERFORATED FLANGE) H250MM - D110MM	360	101	92	172	106	250	76

N.B. SPIGOT LENGTH CAN BE INCREASED USING THE EXTENSION SHANKS. COUPLINGS ARE SUPPLIED TO CONNECT TO DRAINPIPES AND JUBILEE CLIPS ARE ALSO AVAILABLE. PLEASE SEE PAGES 134 & 136 FOR MORE DETAILS.



## EDPM THROUGH-WALL OUTLETS / CONNECTORS

Connectors in EPDM material are also available for drainage holes in the junction between the horizontal and vertical plane. The mouth of these drainage outlets is rectangular rather than round. They can be used in both vertical downpipes or on a horizontal plane.



They can be bonded to EPDM and bituminous membranes in the same way as the downpipes. They are bonded in the sandwich method and can also be mechanically fixed.



Although the flange is not perforated, the surface has a textured surface so the waterproofing or adhesive will still grip onto the material, ensuring a good bond.



The spigot pipe is slightly angled to encourage the flow of water away from the mouth and down. Being made from EPDM the connector is extremely tough, flexible and resistant to UV deterioration and chemical salts.



### THEY ARE MEASURED AS FOLLOWS:

A height of the outlet drainage hole  
 B width of the outlet drainage hole  
 L inner length of the shank or outlet pipe

F1 width of the flange in front of the outlet hole  
 F2 height of the border flap or flange above the outlet hole  
 F3 width of the flange across the face



### A EPDM THROUGH-WALL NON PERFORATED FLANGE – RECTANGULAR SPIGOT

CODE	DESCRIPTION	A (MM)	B (MM)	L (MM)	F1 (MM)	F2 (MM)	F3 (MM)
RD-EPDM-090-300-065-100	EPDM SQUARE CORNER ROOF OUTLET (SMOOTH FLANGE) ·H65MM-W100MM	65	100	425	150	160	340
RD-EPDM-090-300-100-100	EPDM SQUARE CORNER ROOF OUTLET (SMOOTH FLANGE) H100MM ·100MM	100	100	425	150	160	340

**PVC MATERIALS:  
DOWNPIPE OUTLETS IN PVC**

WALLBARN CAN SUPPLY A FULL RANGE OF OUTLETS MANUFACTURED FROM PVC, ENSURING FULL COMPATIBILITY WITH SYNTHETIC MEMBRANES.

The PVC range of outlets follow the same format as those made from TPE and EPDM, but they are not manufactured with perforated flanges, rather smooth borders.

This is because PVC outlets are either welded or adhered to the waterproofing membrane, forming a seamless bond.

However, they should only be used with compatible waterproofing membranes, **so installers and specifiers should be sure to check with the waterproofing manufacturer before purchasing.**

The shaft is similar in design to the TPE outlet and inserted into an HDPE drainpipe. There are ribs on the outer side to help grip the HDPE drainpipe, and on the inner edge at the top there are a series of serrations to hold a leaf guard or gravel excluder.

The PVC downpipe outlets are measured in the same way as the other materials, but please ensure the code numbers are correct when ordering:



**THEY ARE MEASURED AS FOLLOWS:**

- H is the height of the spigot or pipe
- D1 is the outer diameter of the flange or surrounding ring
- D2 is the inner diameter of the pipe at the top
- D3 is the inner diameter of the pipe at the bottom
- D4 is the outer diameter of the pipe at the top

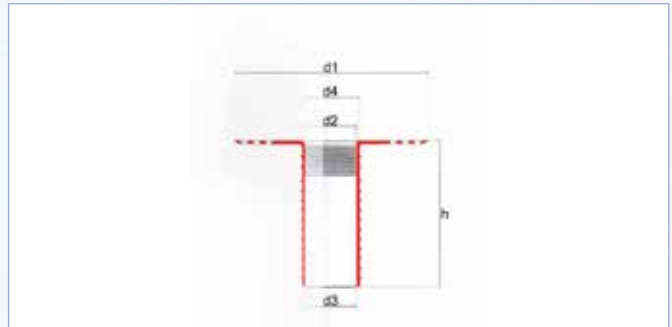

CODE	CATEGORY	D1 (MM)	D2 (MM)	D3 (MM)	D4 (MM)	H (MM)
RO-PVC-120-040-240-040	40MM	235	26	24	31	240
RO-PVC-120-040-240-060	60MM	235	48	43	53	240
RO-PVC-120-040-240-075	75MM	320	65	61	70	240
RO-PVC-120-040-240-080	80MM	280	69	64	74	240
RO-PVC-120-040-240-090	90MM	320	77	73	82	240
RO-PVC-120-040-240-100	100MM	300	89	84	94	240
RO-PVC-120-040-240-110	110MM	320	91	87	96	240
RO-PVC-120-040-240-125	125MM	320	114	109	119	240
RO-PVC-120-041-240-125 SPECIAL FOR HDPE PIPE	125MM	320	111	106	116	240
RO-PVC-120-040-240-140	140MM	380	127	122	132	240
RO-PVC-120-040-240-150	150MM	380	136	131	141	240
RO-PVC-120-040-240-160	160MM	380	146	141	151	240
RO-PVC-120-040-240-200	200MM	440	185	180	190	240



## EXTRA-LONG CONNECTORS

EXTRA-LONG CONNECTORS ARE AVAILABLE FOR INDUSTRIAL ROOFS.

Again, these extra-long units are very similar to the TPE outlet connectors, and are manufactured from PVC. The flange is smooth rather than perforated, but will be fully heat bonded or stuck to the waterproofing membrane using approved adhesive.

The code numbers will differ due to the different material so care must be taken when ordering.

## LEAF GUARDS & GRAVEL EXCLUDERS

Leaf guards or gravel excluders should be fitted into the mouths of the drainage outlets to prevent the drainpipes clogging up over time.

Further details on both these products can be found in the ACCESSORIES SECTION.

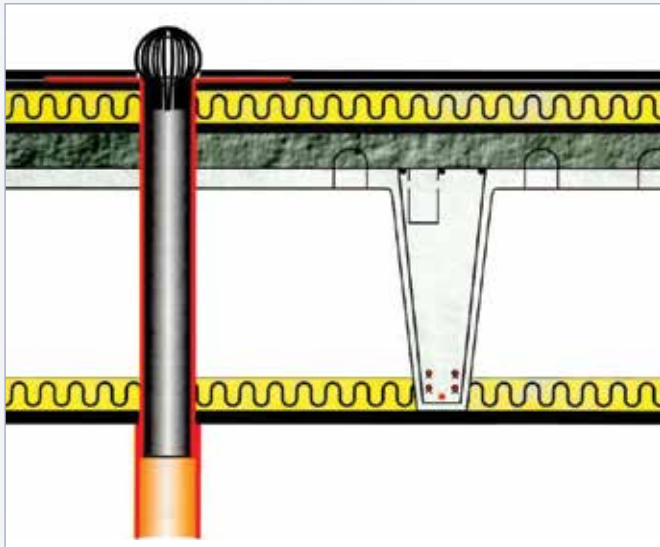

CODE	CATEGORY	D1 (MM)	D2 (MM)	D3 (MM)	D4 (MM)	H (MM)
RD-PVC-120-150-600-080	80MM	370	65	63	72	600
RD-PVC-120-150-600-090	90MM	370	74	72	81	600
RD-PVC-120-150-600-100	100MM	370	85	83	92	600
RD-PVC-120-150-600-110	110MM	390	93	91	100	600
RD-PVC-120-150-600-125	125MM	390	107	105	114	600
RD-PVC-120-150-600-140	140MM	420	125	123	132	600
RD-PVC-120-150-600-150	150MM	420	135	133	142	600
RD-PVC-120-150-600-160	160MM	420	138	136	145	600
RD-PVC-120-150-600-200	200MM	460	178	176	185	600

## THROUGH-WALL OUTLETS IN PVC

A FULL RANGE OF THROUGH-WALL OUTLETS ARE ALSO AVAILABLE IN PVC. THESE ARE MANUFACTURED WITH RECTANGULAR SHAFTS AND ARE SUITABLE FOR OUTLETS THROUGH PARAPET WALLS.

Wallbarn supplies downpipe outlets in PVC with a rectangular mouth. Again, the flange is not perforated in the same way as the TPE outlets, but as with all PVC outlets will be fully bonded to the PVC waterproofing membrane. This design tends to be favoured for pre-cast corner fitting situated between the horizontal deck and the parapet wall or upstand. The corner unit is versatile and adaptable, as it can be used for vertical downpipes as well as horizontal outlets.

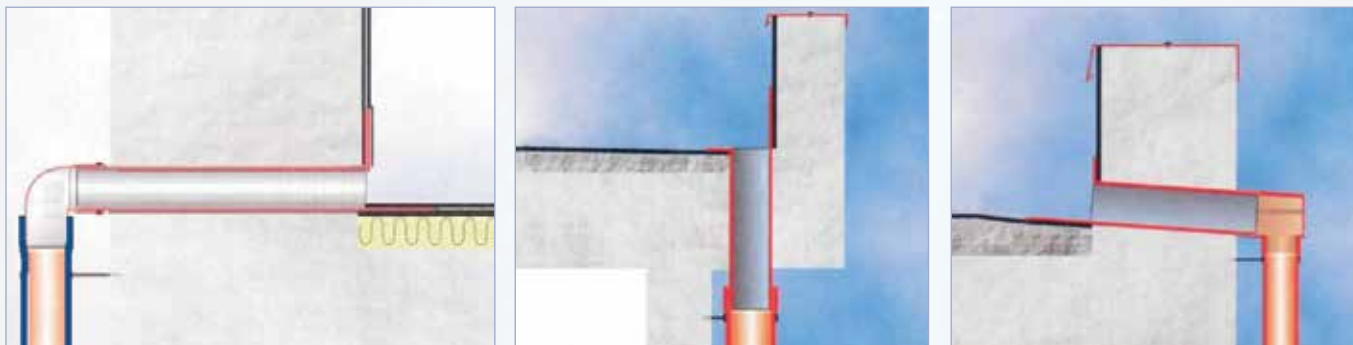
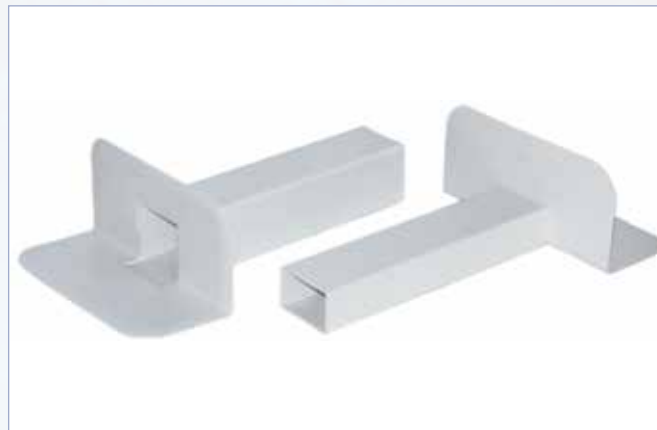

These outlets are available in two versions, with the mouth of the outflow pipe being either 65 x 100mm, or 100 x 100mm for a greater amount of water flow.

## THEY ARE MEASURED AS FOLLOWS:

A height of the outlet drainage hole

B width of the outlet drainage hole

L inner length of the shank or outlet pipe

F1 width of the flange in front of the outlet hole

F2 height of the border flap or flange above the outlet hole

F3 width of the flange across the face



The rectangular corner fittings are available in the following sizes:

CODE	CATEGORY / NAME	D1 (MM)	D2 (MM)	L (MM)	F1 (MM)	F2 (MM)	F3 (MM)
RD-PVC-120-300-065-100	65 X 100MM	65	100	425	150	160	340
RD-PVC-120-300-100-100	100 X 100MM	100	100	425	150	160	340

The shank is 425mm long. Connections can be made easily to HDPE pipework for seamless, waterproof drainage systems.



## THROUGH-WALL OUTLETS WITH A CIRCULAR SHAFT

WALLBARN ALSO OFFERS THROUGH-WALL OUTLETS WITH A ROUND SHANK - FOR FITTING THROUGH WALLS AND PARAPETS AND INTO HDPE DRAINPIPES.



Both the rectangular mouth and the circular mouth outlets can be used on the horizontal or vertical plane. Installers need to ensure that the fall of the roof directs water effectively into the drain pipe without ponding and that the outlet connector is fixed to the drainpipe properly once inside / through the wall.

### THEY ARE MEASURED AS FOLLOWS:

D1 diameter of the outlet drainage hole

F1 width of the flange around the underside of the outlet hole

D2 height of the (recessed) outlet drainage hole

F2 height of the flange to the left and right, and above the outlet hole

D3 inner diameter of the spigot at the bottom

F3 width of the flange across the face

L inner length of spigot

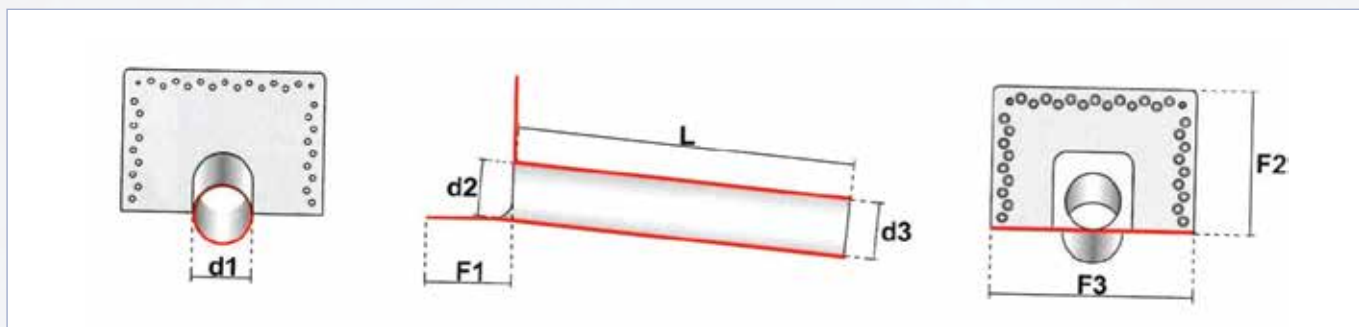

Please note that the length of the shank is 500mm, slightly longer than the shank of the rectangular mouth outlets.

CODE	CATEGORY	D1 (MM)	D2 (MM)	D3 (MM)	L (MM)	F1 (MM)	F2 (MM)	F3 (MM)
RO-PVC-120-350-500-050	50MM	50	43	44	500	110	120	260
RO-PVC-120-350-500-063	63MM	63	56	57	500	130	175	304
RO-PVC-120-350-500-075	75MM	75	68	69	500	130	175	304
RO-PVC-120-350-500-090	90MM	90	83	84	500	130	215	304
RO-PVC-120-350-500-110	110MM	110	103	104	500	130	215	304
RO-PVC-120-350-500-125	125MM	125	118	119	500	130	260	304

## PVC COLLARS



Collars manufactured from PVC are also available for installation as part of a full PVC waterproofing membrane system.

They are fitted around the outside of the pipework which emerges from the top of the concrete deck, things such as foul air vents and stand pipes. Obviously it is important that the small cavity between the cast concrete and the HDPE pipe emitting from the hole is fully sealed, which is why collars are fitted over the whole area and bonded to the waterproofing membrane.

The collars will fit around the outside of an HDPE pipe (as opposed to the connectors and outlets which slot into the inside of a standard water pipe) and are secured using a jubilee clip supplied by Wallbarn. They are manufactured in a slightly conical shape, so that they are easier to fit, and also help direct water outwards away from the pipe and onto the horizontal plane.

As this is a PVC system the collar will be fully bonded to the PVC waterproofing membrane with heat.

The flange of the collar and the membrane beneath are torch-heated until soft, then the two elements are pressed together so that they adhere to one another. It is essential that the correct size of collar is chosen, as it needs to fit around the outer diameter of the HDPE pipe snugly as gaps may cause the system to move.

The jubilee clip is fixed around the collar at the top end to secure the whole area at the end of the process.

### THEY ARE MEASURED AS FOLLOWS:

H is the height of the collar

D1 is the outer diameter of the flange or surrounding ring

D2 is the inner diameter of the collar at the bottom

D3 is the inner diameter of the pipe at the top **which needs to be larger than the outer diameter of the HDPE drainpipe**

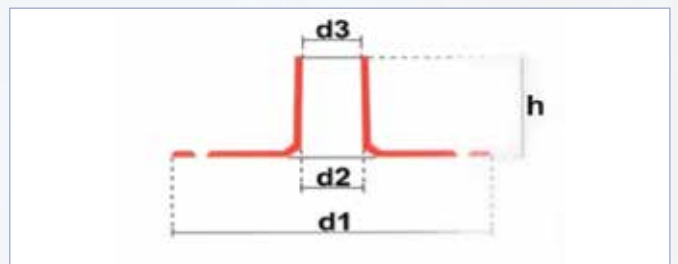

CODE	CATEGORY	D1 (MM)	D2 (MM)	D3 (MM)	H (MM)
RD-PVC-120-370-060-010	10MM	154	11	10	60
RD-PVC-120-370-060-030	30MM	154	32	30	60
RD-PVC-120-370-060-040	40MM	154	42	40	60
RD-PVC-120-370-060-060	60MM	194	62	60	60
RD-PVC-120-370-060-080	80MM	194	82	80	60
RD-PVC-120-370-090-100	100MM	234	102	100	90
RD-PVC-120-370-090-120	120MM	234	122	120	90
RD-PVC-120-370-090-140	140MM	274	142	140	90
RD-PVC-120-370-090-160	160MM	274	162	160	90

### JUBILEE CLIP / STAINLESS STEEL FIXING BAND

Please see our ACCESSORIES SECTION.



## VENTS & AERATORS IN PVC

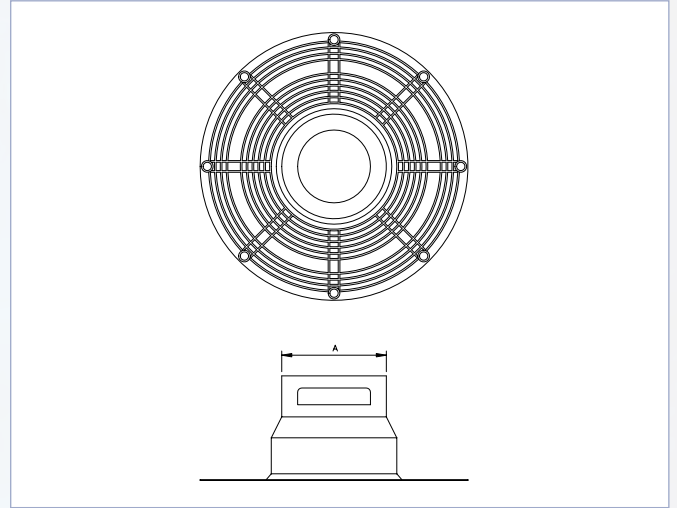

Wallbarn also supplies vents in PVC, for use with compatible synthetic waterproofing membranes. They are designed to aerate the concrete and help the structure to breathe.

As with the TPE Vents for bituminous membranes, PVC decks will also require sufficient aeration to avoid vapour build-up and potential blistering of the waterproofing membrane. The vent is designed to draw this moisture away from the concrete slab. It is placed onto the bare concrete beneath the waterproofing membrane and insulation.

These vents are installed in a different manner to the TPE varieties in that they will be heatbonded to the PVC waterproofing membrane, or be bonded with a suitable adhesive, beneath the main membrane. Applicators should get advice from the waterproofing manufacturer for the best installation technique.

The membrane is applied over the base of the vent. This creates a “flue” which helps to draw the vapour out of the concrete.

There are a series of ribs along the underside of the round base plate (or flange) to encourage the vapour movement. The ribs on the underside stop about 5 cm from the edge of the base or flange in order to help with the bond between the PVC membrane and the unit.

The top of the pipe or flue has three lateral holes to allow the vapour to escape into the atmosphere. It is covered by a hood or cap which overlaps the internal holes, preventing rainwater entering the system but still allowing the passage of vapour.

Wallbarn recommends a vent is placed at least every 25m<sup>2</sup>.

As with the other material, Wallbarn can supply the PVC vent in three different sizes. The standard vent (on the left hand side) has a flue of 240mm high and approximately 75mm in diameter. This is the most common type of vent produced.

A shorter, broader vent can also be produced if a shorter pipe is required or the extra-long vent pipe, at 400mm is also available.



Please see our **CAD Images section on our website** for more help in detailing these areas.

The PVC vents are UV stable and resistant to the elements. They are designed to be extremely tough and durable, and are designed for long-term durability.

## THEY ARE MEASURED AS FOLLOWS:

D1 is the diameter of the base plate / flange

D2 is the diameter of the flue or pipe at the bottom of the vent

D3 is the diameter of the flue or pipe at the top (where it meets the cap / hood)

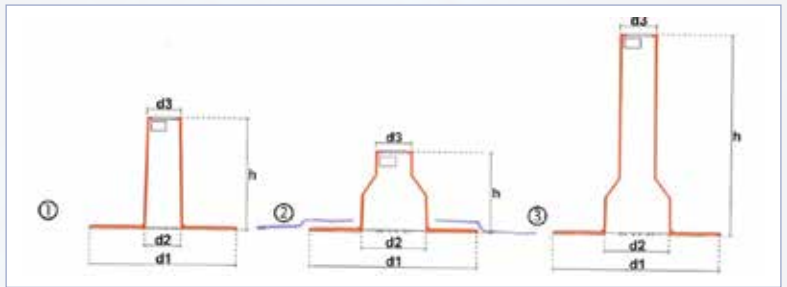

CODE	DESCRIPTION	D1 (MM)	D2 (MM)	D3 (MM)	H (MM)
RO-PVC-120-420-240-075	STANDARD VENT 240MM HIGH	320	76	73	240
RO-PVC-120-460-160-125	SHORT VENT 160MM HIGH	390	125	73	160
RO-PVC-120-460-400-125	EXTRA-LONG VENT 400MM HIGH	390	125	73	400

## CAPS FOR VENTS

Installers will also need to ensure they purchase a cap or hood for all of these vents. The black plastic caps will fit onto the PVC vent shafts easily and are fully compatible. There are two designs of hood / flue – a standard round cap; and a special ESTRAER® funnel shaped hood. This comprises of two conical funnels which join up at a central hole at the top of pipe, and create an extra suction on the pipe, helping to draw out a greater amount of vapour and air from the concrete.



The standard cap is measured so that D1 is the diameter of the cap at the top; D2 is the diameter at the bottom (where it slots onto the pipe) and H is the height of the cap.

The special ESTRAER® cap is measured so that D1 is the diameter of the cap at the bottom (where it slots onto the pipe); D2 is the diameter of the funnels at each side; and H is the overall height of the cap including the funnels.



CODE	DESCRIPTION	D1 (MM)	D2 (MM)	D3 (MM)	H (MM)
RO-TPE-030-500-900-080	STANDARD CAP (BLACK)	106	110	-	80
RO-TPE-030-500-900-010	ESTRAER® CAP (BLACK)	75	82	-	140



**ACCESSORIES:**

A NUMBER OF DIFFERENT PRODUCTS ARE AVAILABLE TO WORK BOTH IN CONJUNCTION WITH THE OUTLETS AND VENTS AND ALSO FOR USE WITH WATERPROOFING MEMBRANES GENERALLY.

**LEAF GUARDS**

LEAF GUARDS AND GRAVEL EXCLUDERS ARE REQUIRED FOR CIRCULAR ROOF OUTLETS TO PREVENT THE HDPE DRAINPIPE BECOMING BLOCKED OVER TIME, LEADING TO FLOODING.

Wallbarn offers leaf guards in a number of different materials which ensure that water can drain efficiently.

Wallbarn leaf excluders are made from zinc plated iron, copper or plastic.

These leaf guards can fit into all the different designs of circular outlets and connectors. They are compatible with all the different materials manufactured.

They are manufactured with 12 rods at the bottom. They are flexible and spring loaded, and have a slightly serrated edge.

The leaf guard is inserted into the top of the hole.

The serrated edges will grip onto the inside of the drain connector or outlet, which has a series of small ridges around the inside rim of the shaft. This helps lock the guard into place.

They do not need to be stuck into the hole. As the water flows into the pipe the pressure will be downwards, so the guard will remain in place without issue.

They can be removed, however, by squeezing the sides of the cage frame to narrow the bottom edges.

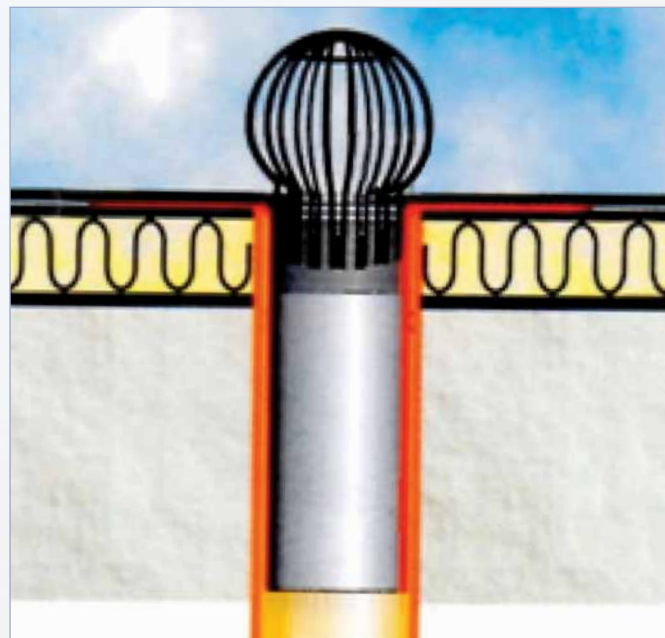
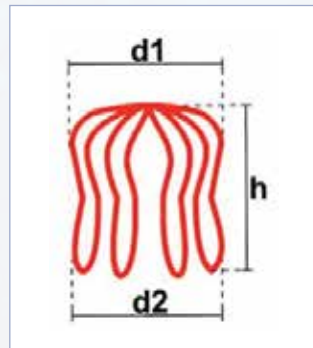

CODE	DESCRIPTION	D1 (MM)	D2 (MM)	H (MM)
RO-LEAFGUARD-210-015-125-010	ZINC IRON LEAF GUARD	120	115	110
RO-LEAFGUARD-210-015-125-020	COPPER IRON LEAF GUARD	120	115	110
RO-LEAFGUARD-210-020-080-125	PLASTIC LEAF GUARD	140	50	160
RO-LEAFGUARD-210-015-125-030	STAINLESS STEEL LEAF GUARD	120	115	110

## SQUARE LEAF GUARDS FOR CORNER OUTLETS

Wallbarn supplies leaf guards manufactured in a square shape, specially designed for the through-wall / parapet outlets.

Made from a durable and hardwearing plastic compound, they provide a secure fit into the mouth of the corner outlets to prevent drains becoming blocked.

They are simply inserted into the mouth of the hole and will remain in place without fixings or adhesive.



CODE	NAME	WIDTH (MM)	INNER WIDTH* (MM)	HEIGHT (MM)
RO-LEAFGUARD-210-030-090-010	CORNER ROOF OUTLET - SQUARE SHAPED PLASTIC LEAF GUARD	170	90	115

\*Distance from mouth of drainage pipe and edge of cage

## GRAVEL EXCLUDERS

Gravel excluders work in the same way as the leaf guards, but they are more heavy duty, and can withstand the higher pressure and impact of gravel and stones. They are manufactured from plastic, which is UV resistant and resistant to ambient atmospheric elements.



The shaft fits into the outlet hole for a tight, secure fit. The HELIX excluder can have its spokes trimmed to fit the diameter of the pipe before being inserted. The SPIDER excluder is manufactured with its spokes turning upwards, to aid insertion and help grip the inside of the pipe, preventing it rising out.

### THEY ARE MEASURED AS FOLLOWS:

D1 diameter of cap at the top

D2 diameter of fins / prongs at the bottom

H height from top of cap to bottom of fins / prongs

H1 height / thickness of cap

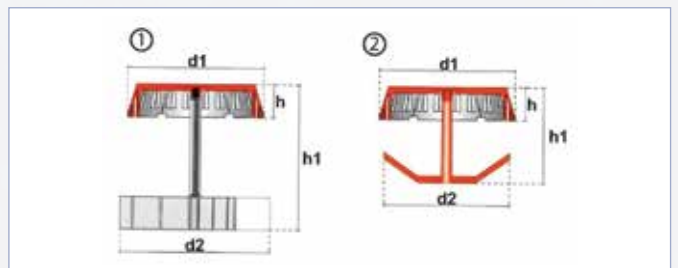

CODE	NAME	D1 (MM)	D2 (MM)	H (MM)	H1 (MM)
RO-LEAFGUARD-210-030-075-200	CIRCULAR ROOF OUTLET - HELIX GRAVEL EXCLUDER	208	230	50	220
RO-LEAFGUARD-210-030-080-200	CIRCULAR ROOF OUTLET - SPIDER GRAVEL EXCLUDER	208	192	50	140



## EXTENSION SHANKS IN TPE

Wallbarn supplies extension shanks designed to fix up with the drainage outlets to increase the reach into the parapet wall or drainage channel.

Often the ducts and channels will have to pass through a long run of concrete before reaching a suitable area to install the HDPE drainpipe, so an extension of a fully waterproof sealed connector will be required.

These extension shanks are specially designed to fit in with the full range of Wallbarn circular outlets. They are made from TPE but can still be used with EPDM and PVC outlets. They are manufactured to a slight cone shape, so the end of the circular outlet slots inside the top of the extension shank. The two membranes are bonded together using silicone adhesive.

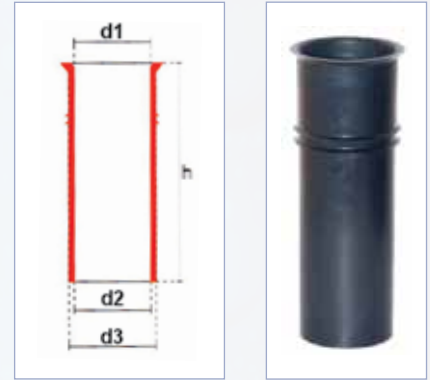

**Installers of PVC waterproofing systems should always inform their waterproofing manufacturer before using these two materials together in order to check the status of the warranty.**

CODE	CATEGORY	D1 (MM)	D2 (MM)	D3 (MM)	H (MM)
RO-TPE 210-040-240-040	40MM EXTENSION PIPE	26	24	31	240
RO-TPE 210-040-240-060	60MM EXTENSION PIPE	48	43	53	240
RO-TPE 210-040-240-075	75MM EXTENSION PIPE	65	61	70	240
RO-TPE 210-040-240-080	80MM EXTENSION PIPE	69	64	74	240
RO-TPE 210-040-240-090	90MM EXTENSION PIPE	77	73	82	240
RO-TPE 210-040-240-100	100MM EXTENSION PIPE	89	84	94	240
RO-TPE 210-040-240-110	120MM EXTENSION PIPE	91	87	96	240
RO-TPE 210-040-240-125	125MM EXTENSION PIPE	114	109	119	240
RO-TPE 210-040-240-125	125MM EXTENSION PIPE SPECIAL FOR HDPE PIPE	111	106	116	240

## JUBILEE CLIP / STAINLESS STEEL FIXING BAND

Jubilee clips will be required when fitting pipe collars, which are available in both TPE and PVC. These clips or bands are manufactured in stainless steel AISI 304 and secure the collars onto the foul air pipes emitting from the roof or deck.

They are a regular, simple design with the size of the band and the force of the clamp easily adjusted by turning the mechanism with a screwdriver.

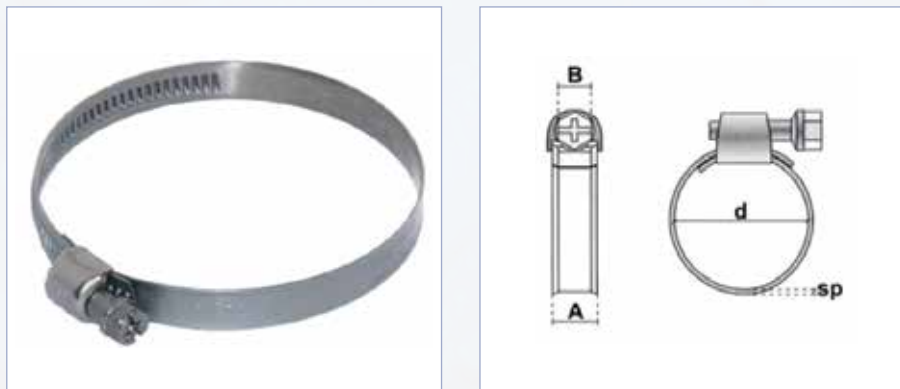

## SIZES ARE AS FOLLOWS:

CODE	NAME	DIAMETER RANGE (MM)	A	SP THICKNESS	B	TORQUE
RO-CLIP 210-370-009-008	INOX 9/8-16	8-16	9	0.6	7	8
RO-CLIP 210-370-009-025	INOX 9/25-45	25-45	9	0.6	7	8
RO-CLIP 210-370-009-050	INOX 9/50-70	50-70	9	0.6	7	8
RO-CLIP 210-370-009-070	INOX 9/70-90	70-90	9	0.6	7	8
RO-CLIP 210-370-009-090	INOX 9/90-110	90-110	9	0.6	7	8
RO-CLIP 210-370-009-110	INOX 9/110-130	110-130	9	0.6	7	8
RO-CLIP 210-370-009-140	INOX 9/140-160	140-160	9	0.6	7	8
RO-CLIP 210-370-012-135	INOX 12/135-165	135-165	12	0.6	7	8

## PATCHES IN TPE MATERIAL

Wallbarn supplies a range of acute and obtuse angles manufactured from TPE. They are fitted into difficult areas as an additional protection.

Often a liquid waterproofing membrane can either struggle to bond to a very sharp corner, or on an outer corner can be “scalped” as it is applied, leading to a much thinner layer than the rest of the area.

These areas of the concrete deck can be the most vulnerable to leakage, so extra protection and strength across such details is achieved by a flexible, durable “patch”, which will adhere to the liquid waterproofing membrane and can improve the integrity of the waterproof seal. **They are available in the following sizes:**

CODE	NAME	HEIGHT (MM)	ANGLE°
RD-TPE-030-540-050-095	ACUTE CORNER JOINT (SMALL) IN TPE	95	95
RD-TPE-030-540-050-130	ACUTE CORNER JOINT (LARGE) IN TPE	130	130
RD-TPE-030-540-550-095	OBTUSE CORNER JOINT (SMALL) IN TPE	95	95
RD-TPE-030-540-550-130	OBTUSE CORNER JOINT (LARGE) IN TPE	130	138
RD-TPE-030-540-550-100	SQUARE OBTUSE CORNER JOINT IN TPE	106	110
RD-TPE-030-540-900-013	TAPERED CONE COVERING 13MM AT TOP	75	82



## PATCHES IN PVC

THE SAME TYPES OF JUNCTIONS AND SHAPES FOR BITUMINOUS MEMBRANES MANUFACTURED IN PVC FOR SYNTHETIC MEMBRANES.

Wallbarn supplies the same type of reinforcement patches in PVC, for use with compatible synthetic sheet membranes.

Although most PVC membranes are manufactured in standard sheet form to a uniform shape, they may also require an additional layer around awkward details and areas which are likely to get scuffed or stretched.

These areas of the concrete deck can be the most vulnerable to leakage, so extra protection and strength across such details by a flexible, durable “patch”, which will adhere to the liquid waterproofing membrane, can improve the integrity of the waterproof seal.

In addition to the acute and obtuse angles, we also have on offer a “star-shaped” piece which can be manipulated in a large number of different shapes, ideal for very tricky corners and angles. **The patches are available in the following sizes:**

CODE	NAME	HEIGHT (MM)	ANGLE°
RD-PVC- 120-540-050-095	ACUTE CORNER JOINT (SMALL) IN PVC	95	95
RD-PVC- 120-540-050-110	CONICAL CORNER JOINT IN PVC	110	110
RD-PVC- 120-540-050-130	ACUTE CORNER JOINT (LARGE) IN PVC	130	130
RD-PVC- 120-540-550-095	OBTUSE CORNER JOINT (SMALL) IN PVC	95	95
RD-PVC- 120-540-550-130	OBTUSE CORNER JOINT (LARGE) IN PVC	130	138
RD-PVC- 120-540-900-013	TAPERED CONE COVERING 13MM AT TOP	75	82
RD-PVC- 120-540-550-110	FULLY FLEXIBLE STAR-SHAPED JOINT	110	110



## COUPLINGS

### SQUARE SHAPED SPIGOT

Wallbarn supplies a range of couplings for use in securing the drainage outlet to the HDPE drainpipe.

Couplings manufactured with a square mouth one side are designed for use where the through-wall outlet is connected via a right angle to a rounded drainpipe. The square shaped spigot is placed inside the square mouth of the coupling and the rounded downpipe section is fitted inside the HDPE pipe. A jubilee clip can be used around the drainpipe to give a secure fit.

These units are available in a number of different sizes.

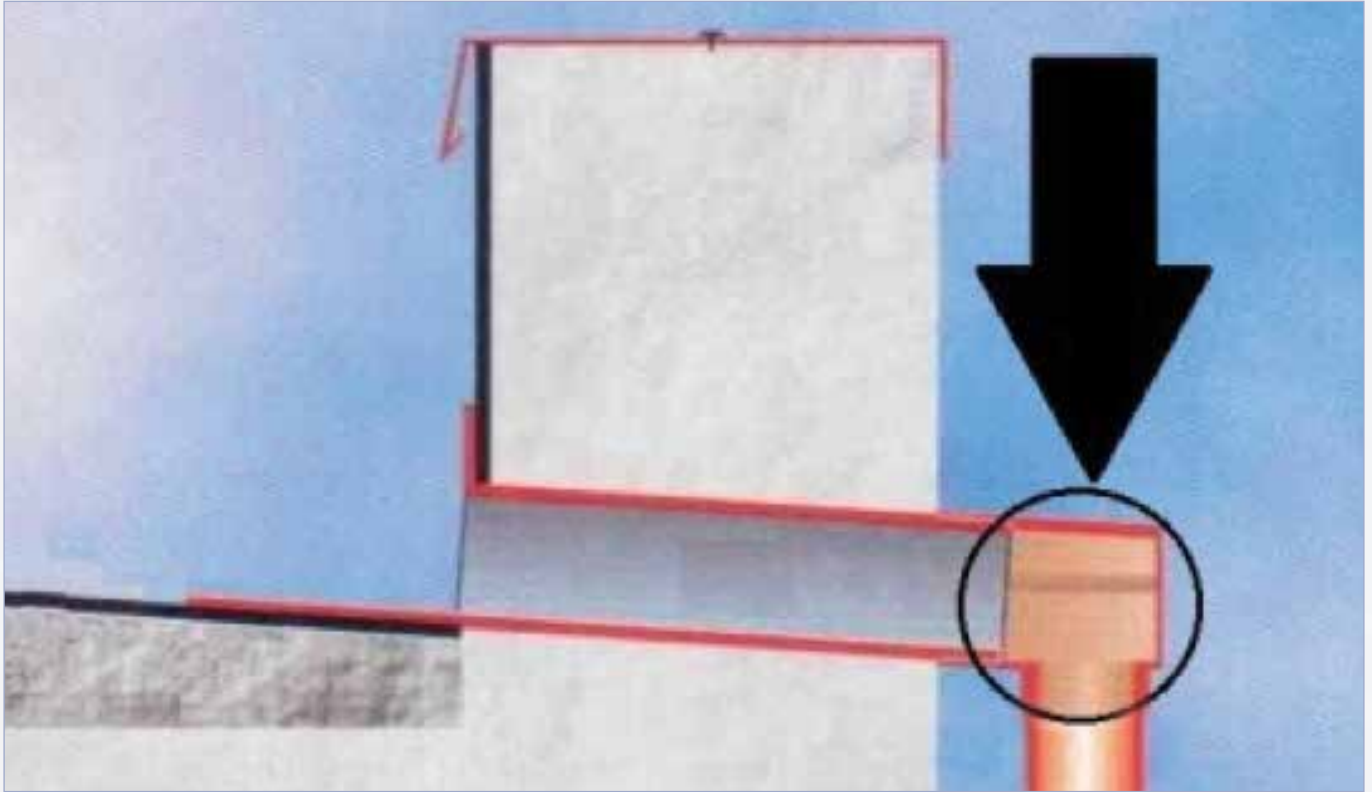

65mm high x 80mm wide



210-300-065-080

65mm high x 100mm wide



210-300-065-100

100mm high x 80mm wide



210-300-100-080

100mm high x 100mm wide



210-300-100-100

DIAMETER	CODE
65 X 80MM	210-300-065-080
65 X 100MM	210-300-065-100
100 X 80MM	210-300-100-080
100 X 100MM	210-300-100-100

## RIGHT ANGLE COUPLING FOR USE WITH ROUND SPIGOTS

Wallbarn also supplies couplings for use with rounded spigots. Through-wall roof outlets installed either vertically or horizontally can be fitted to the HDPE drainpipe using the right angled “elbow” coupling connector.

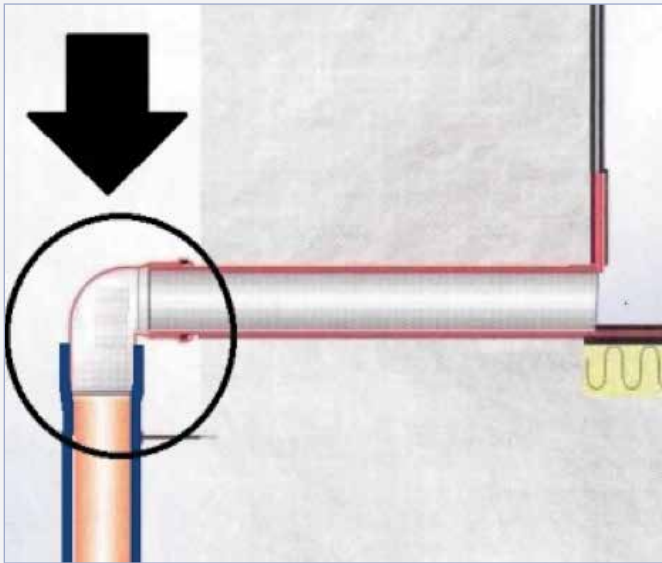

They are available in a variety of sizes:

DIAMETER	CODE
50MM	210-350-050-050
75MM	210-350-075-075
90MM	210-350-090-090
110MM	210-350-110-110
125MM	210-350-125-125



## ROUND SPIGOT STRAIGHT COUPLING

A straight coupling is available for fixing a Wallbarn outlet with a round spigot to a round HDPE drainage pipe when the drainpipe is going in the same direction.

These can be used for through-wall outlets which have a round spigot and also downpipe and circular drainage outlets.

The spigot again fits inside the coupling and additional secure fit can be achieved by tightening a jubilee clip around the outside.

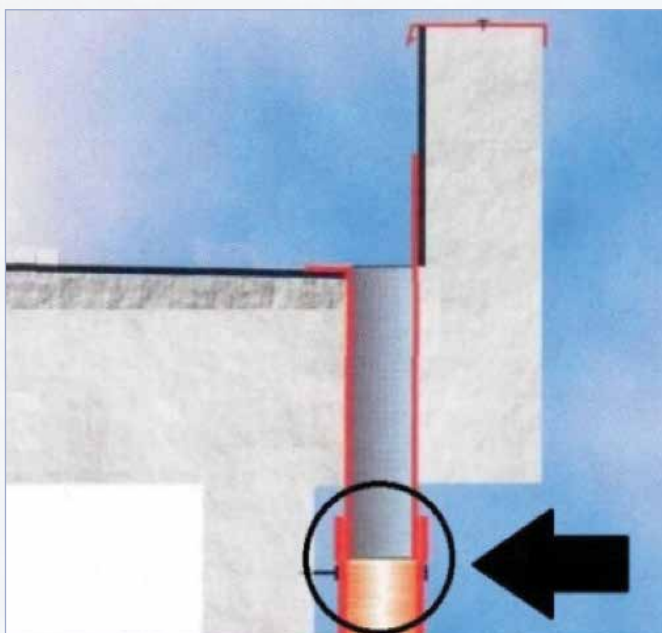

DIAMETER	CODE
50MM	210-360-050-050
75MM	210-360-075-075
90MM	210-360-090-090
110MM	210-360-110-110
125MM	210-360-125-125





## PROTECTION MEMBRANES

Sheet membranes designed to protect waterproofing from abrasion or puncture damage.

### PROTECTO-BOARD – BITUMINOUS



### PROTECTO-MAT – RUBBER CRUMB





## PROTECTO-BOARD – BITUMINOUS

This semi flexible board is a convenient way to ensure adequate protection to waterproofing membranes against damage caused by site traffic, other trades, mechanical damage and ground settlement.

Made from a mixture of fibres saturated with at least 75% bitumen, Bituminous Protecto-board is completely waterproof and provides superior impact and abrasion resistance.

Bituminous Protecto-board is ideal for vertical applications since it can be heat bonded, providing very good adhesion.

**Wallbarn Bituminous Protecto-board is available 3mm and 6mm thick.**

Protecto-board is ideal for protection against backfill on vertical waterproofing; against other site traffic and works during the construction process; against ground movement in foundation wall structures; on green roofing; as a recovery board for overlaying existing systems, and as permanent protection layer on more delicate horizontal membranes.



Protecto-board is lightweight and easy to handle. It can be used on both horizontal and vertical applications and can be bonded directly onto the waterproofing membrane without interfering with the seal. It is covered one side with a polyethylene film, meaning the bitumen does not bleed during storage or after application onto other surfaces.



It is very easy to handle and apply. The boards will tolerate high temperatures so can be laid directly into hot melt waterproofing membranes without issue. The boards can be spot bonded or fully bonded to the membrane beneath or loose laid and taped around the edges of each board. They can also be mechanically fixed to the surface beneath.

Protecto-board can also be torch applied. The boards are flexible and adaptable and can be folded and cut easily to give accurate detailing.



The material is supplied in 1m x 2m sheets and packed onto double size pallets for effective movement to site. The pallets hold 200 x 3mm sheets or 100 x 6mm sheets.



The pallets are tightly strapped and mechanical lifting equipment is recommended to offload. Each sheet is covered both sides with a polythene film which prevents the boards sticking together on the pallet in warmer temperatures. None of the bitumen will bleed out, so issues such as liquid bitumen or fumes affecting applicators is avoided.

Installation is fast and straightforward.



Protecto-board can be left exposed for a certain period of time and will not delaminate when coming into contact with water.





Bituminous Protecto-board is designed to be user friendly and easy to install. It has been used successfully on basement tanking, podium decks, roofs, tunnels, waterways and civil engineering projects. By installing a protection membrane applicators can have an added assurance that waterproofing membranes will be protected over time.



The boards are flexible enough to manipulate and shape around particular details. The sheets can be scored or cut with a sharp knife to fit around corners and multiple layers can be fitted on top of one another to give extra protection on susceptible areas.

It is a highly adaptable product. It can be spot bonded using adhesive, fixed with double sided bitumen tape, or heat bonded to the surface. Multiple sheets can be bonded together to form a uniform layer, and because of its light weight, it can be held in the vertical position in the long term.



Bituminous Protecto-board can be used as a permanent layer, part of the waterproofing system, or as a temporary protection which is removed after the passing trades have finished.

These boards are very tough and durable and can withstand concrete pour easily. The boards are rot-proof and will not delaminate even when immersed in water, unlike many card fibre based protection boards on the market. They are intended to provide long term protection for waterproofing systems.

CODE	PB-BIT-03	PB-BIT-06		
PROPERTIES	TEST METHOD	UNITS	TYPICAL VALUES	
THICKNESS	EN 1849-1	MM	3.1	6.1
DIMENSIONS	EN 1848-1	M	2 x 1	2 x 1
MASS PER UNIT AREA	EN 1849-1	KG/M <sup>2</sup>	4.09	8.34
BITUMEN CONTENT			>75%	
SOFTENING POINT			115°C-130°C	
POLYTHENE FILM		μ	15	
RESISTANCE TO STATIC LOADING	EN 12730	KG	25	
RESISTANCE TO IMPACT	EN 12691	MM	>700	
PUNCTURE RESISTANCE	ASTM E-154	N/MM	1,474N/37MM	1,497N/34MM
WATERTIGHTNESS TO WATER	EN 1928-1	KPA	>400	

Tested in ISO 9001 certified laboratory 03/01/2013 and witnessed by Inspectorate International (Saudi Arabia) Ltd

## PROTECTO-MAT – RUBBER CRUMB

Wallbarn Rubber Crumb Protecto-mat is a very flexible and easy-to-install protection membrane for use on a large variety of surfaces, applications and membranes. It is durable and tough and has a density of 950 kg/m<sup>3</sup>.

It has been developed and selected for waterproofing systems where bituminous protection boards are not compatible, such as Polyurethane or PVC single ply membranes.

It protects the waterproofing membrane both during the construction process from damage caused by abrasion, point loading, blunt materials, backfilling and concrete casting; and can also form part of a long-term after completion as a permanent protection, thus ensuring and extending the lifespan of the membrane.

It is manufactured in a non-rigid roll format from rubber crumb, sourced from recycled rubber. This makes it one of the greenest and sustainable protection membranes on the market. The rubber crumb particles are bound together with a mixture of polyurethane resins to form a strong membrane which will not delaminate when exposed to the elements.



It is ideal for horizontal and vertical surface protection for applications such as podium decks, green roofs, regularly trafficked roofs, inverted roofs, parking areas, walkways, on maintenance areas; in underground waterproofing such as foundation walls, basements, drains, tunnels, and ditches.

It is lightweight and non-toxic to handle, making it a much better prospect for site handling than other protection boards.

It is strong enough to tolerate concrete pour and the application of hot materials straight onto its surface.



Wallbarn Protecto-mat is ideal for vertical surfaces and detailing and can be easily cut using a sharp knife and shaped around particular corners and details.



Protecto-mat rubber crumb membrane comes in rolls rather than sheets. It is important that each roll is overlapped. Wallbarn advises that rolls are overlapped by at least 8cm during installation, to ensure the whole area is fully protected. It is important to ensure that each roll is fitted securely to the next roll.

It is recommended that applicators seek the advice of the manufacturer of the waterproofing membrane on the best way to secure the protection.



This membrane is completely rot-proof. It can be immersed in water without risk of delaminating or compromising its performance.

## TECHNICAL DATA

PHYSICAL-MECHANICAL PROPERTIES								
DESCRIPTION	M.U.						NORMS	TOLERANCES
RUBBER THICKNESS	MM	2	3	4	5	6	EN 13849-1	± 10%
RUBBER DENSITY	KG/M3	950						± 7%
ELONGATION AT BREAK	%	35					EN ISO 1798	± 5%
TENSILE STRENGTH	N/MM2	0.9					EN ISO 1798	± 2%
STATIC PUNCTURE RESISTANCE	KG	30	30	35	40	45	EN 12730 MET B	MIN
DYNAMIC PUNCTURE RESISTANCE	MM	≥2250	≥2250	≥2250	≥2250	≥2500	EN 12691 MET. A	MIN
HEAT RESISTANCE (PROLONGED PERIOD)	°C	UP TO +90						-
HEAT RESISTANCE (COMPROMISED POINT)	°C	+130						
HEAT RESISTANCE (DISINTEGRATION POINT)	°C	+160						
IGNITION POINT	°C	+300						-
COLD RESISTANCE (PROLONGED POINT)	°C	UP TO -30						
COLD RESISTANCE (COMPROMISED POINT)	°C	-120						
FIRE RATING		B2					DIN 4102	-
SHORE A HARDNESS		50						± 10%

THERMAL PROPERTIES					
DESCRIPTION	SYMBOL	M.U.	VALUE	NORMS	NOTES
THERMAL CONDUCTIVITY	(λ)	W/MK	0.1226	UNI EN 12667:2002	CERT.N° 078-09-THE TR

CHEMICAL PROPERTIES	
CHARACTERISTIC	PERFORMANCES
RESISTANCE TO MICROBES	RESISTANT TO FUNGI, INSECTS AND MICROBE ATTACK
CHEMICAL INTERACTION	HIGHLY RESISTANT TO ACIDS AND ALKALINE DETERGENTS, ROT-PROOF
ELECTROSTATICS	DOES NOT ACCUMULATE STATIC CHARGE AND PREVENTS STATIC MOVEMENT BETWEEN MATERIALS
ECCO-SUSTAINABILITY	100 % RECYCLABLE
STATIC PUNCTURE RESISTANCE	KG

DIMENSIONS AND PACKAGING							
	M.U.	VALUE					TOLERANCES
THICKNESS	MM	2	3	4	5	6	10%
ROLL HEIGHT	M	1	1	1	1	1	2%
ROLL LENGTH	M	18	15	12	10	8	1%
WEIGHT PER M2	KG/M2	1.9	2.25	3	3.75	4.5	7%
NUMBER OF ROLLS PER PALLET	PCS	16	16	16	16	16	
TOTAL AREA PER PALLET	M2	288	240	192	160	128	
PALLET DIMENSION	CM	100X120X110CM					





## GEOTEXTILE FABRICS





## GEOTEXTILE FABRICS

Wallbarn supplies a large range of geotextile fabrics suitable for a wide number of uses – including protection, drainage, filtration, soil stabilisation & green roofing.

These nonwoven fabrics are strong, flexible but permeable membranes which allow water to pass through but hold the particles in place. The soil does not become saturated, thereby improving the strength and stability of the ground.

The geotextile is manufactured through a thermal process without the use of glues or staples. The fabric is run through a number of super heavy presses to ensure the fibres are securely bonded. The makeup of the fabric is uniform throughout the roll, so no weak spots will be present in the layer.



A number of different grades and strengths of fabric are available from Wallbarn, depending on the exact nature of the project.

Wallbarn supplies geotextile fabrics manufactured from virgin fibre polypropylene or recycled polyester. The material is supplied packed into tight rolls and we can supply material in a very large variety of roll sizes, from 1 metre wide up to 6 metres wide for very large-scale projects.



These super-jumbo rolls are designed for use for very large projects, such as road construction, reservoirs and landfills. Using very wide rolls reduces the number of joints between individual rolls. This cuts down on labour by having less individual rolls to stitch together, and also makes the whole fabric layer stronger by having less weak points at the joints.



For applications such as roofing, smaller rolls would be required to make access to the roof space easier. Wallbarn can supply all its geotextile fabrics in 1 metre wide rolls for these purposes.





## HIGH TENACITY VIRGIN FIBRE GEOTEXTILE

The prime material supplied by Wallbarn is a high tenacity polypropylene fabric (PPST). This material goes through a special process during manufacture to give it increased tensile strength and puncture resistance. It is available in different weights and has been fully tested to comply with specifications for a large range of uses such as road, rail and runway construction, landfills and reservoirs.



Its soft, cushioning properties mean it can be placed onto rough areas to prevent sharp objects from passing through into the system above but still allow the passage of water. This means sealing and waterproofing sheet membranes can be installed above them without the risk of ground settlement causing any damage above.



At much lower weights, the high tenacity polypropylene fabric has also been used as an effective protection layer for waterproofing membranes including single ply sheet membranes. The cushioning effect is seen as a major advantage. It has been used successfully as a separation layer in inverted waterproofing systems, protecting the insulation boards from damage caused by the ballast.

Wallbarn can offer different grades of fabric to match up to the technical specifications required for each project. A second grade of virgin fibre polypropylene fabric is available called PPEXT is available with slightly lower mechanical properties to provide a more cost effective solution.

They are often used as subterranean soil stabilisation membranes. Either covering buried pipes or lining drains, they will ensure the passage of water without risk of land slippage, greatly improving the quality of the area. They can also be used on areas where new built-up ground is being created, such as artificial islands and reclaimed land, to prevent subsidence before the soil is fully consolidated.

## RECYCLED POLYESTER GEOTEXTILE - PECT

Designers and installers can choose a more sustainable option by using recycled polyester fabrics.

Although these materials have much lower tensile strength and mechanical properties of the virgin fibre materials, recycled polyester fabrics can be used effectively as separation and filtration layers. They are ideal for green roof applications since they are made from recycled fibres. Wallbarn uses the multi-coloured PECT recycled polyester fabrics within its own M-Tray® green roof system build-up.



All Wallbarn geotextile fabrics are manufactured under ISO 9001:2000 standards and comply with Directive 89/10/EEC 1988 (as amended by 93/68/EEC 1993). Fabrics can be coloured and engineered so that the UV resistance is extended beyond the standard 15 days should any fabric be exposed for prolonged periods.



# PPST HIGH STRENGTH POLYPROPYLENE

PHYSICAL PROPERTIES		TEST METHOD	UNIT	TOLERANCE																																	
WEIGHT / MASS PER UNIT AREA		EN ISO 9864	G/M²	70	90	100	110	120	130	150	180	200	230	250	280	300	320	350	380	400	450	500	600	700	800	1000	1200	1500	2000	±	10%						
THICKNESS		EN ISO 9863-1	MM	0.40	0.60	0.65	0.70	0.80	0.90	1.00	1.20	1.30	1.40	1.50	1.55	1.60	1.65	1.80	2.20	2.50	2.65	3.00	4.00	5.00	5.50	6.50	7.00	7.50	7.50	±	20%						
MECHANICAL PROPERTIES																																					
TENSILE STRENGTH	MD	EN ISO 10319	KNM	3.2	6.0	7.0	8.0	9.0	10.0	12.0	14.0	16.0	18.0	20.0	23.0	25.0	25.0	27.0	28.0	30.0	32.0	35.0	40.0	45.0	50.0	60.0	70.0	70.0	85.0	75.0	-	10%					
	CMD	EN ISO 10319	KNM	3.5	6.0	7.0	8.0	9.0	10.0	12.0	14.0	16.0	18.0	20.0	23.0	25.0	27.0	30.0	32.0	34.0	36.0	40.0	50.0	65.0	80.0	90.0	105.0	140.0	155.0	-	10%						
ELONGATION AT MAX LOAD	MD	EN ISO 10319	%	55	55	55	55	55	55	55	60	60	65	65	65	65	70	70	70	70	70	80	80	80	80	80	80	80	80	±	30%						
	CMD	EN ISO 10319	%	60	60	60	60	60	60	60	65	65	70	70	70	70	70	70	70	70	70	80	80	80	80	80	80	80	80	±	30%						
ENERGY INDEX		EN ISO 10318	KJ/M²	1.0	1.7	2.0	2.3	2.6	2.9	3.5	4.4	5.0	6.1	6.8	7.8	8.4	9.1	10.0	10.5	11.2	13.6	15.0	18.0	22.0	26.0	30.0	35.0	45.0	46.0	±	20%						
STATIC PUNCTURE RESISTANCE		EN ISO 12236	KN	0.7	0.9	1.2	1.3	1.5	1.7	1.9	2.2	2.4	2.7	3.0	3.5	4.0	4.2	4.5	5.0	5.5	6.0	6.5	8.0	9.0	10.0	13.0	14.0	18.0	20.0	-	10%						
DYNAMIC PUNCTURE RESISTANCE (CONE DROP TEST)		EN ISO 13433	MM	>50	44	38	34	32	30	26	22	20	16	14	12	10	10	8	8	6	6	4	2	1	0	0	0	0	0	+	20%						
PYRAMID PUNCTURE RESISTANCE		EN 14574	N	N/A	N/A	N/A	N/A	N/A	N/A	N/A	N/A	200	220	280	320	330	335	340	350	350	400	500	700	900	1000	1300	1600	2200	2200	-	20%						
HYDRAULIC PROPERTIES																																					
PERMEABILITY NORMAL TO THE PLANE		EN ISO 11058	MMS	130	130	125	120	115	110	100	95	90	80	75	70	65	60	50	40	35	30	30	25	20	20	15	15	15	5	-	30%						
IN-PLANE FLOW CAPACITY		EN ISO 12958	10-3L/MS	0.8	0.80	0.80	0.80	0.80	0.80	1.60	1.60	2.10	2.10	2.30	2.30	2.50	2.50	2.70	2.80	3.20	4.00	5.00	7.80	8.00	8.50	9.00	9.00	9.00	7.00	-	30%						
TRAMISSIVITY		EN ISO 10318	L/M S	0.80	0.80	0.80	0.80	0.80	0.80	1.60	1.60	2.10	2.10	2.30		2.50		3.20				5.00		8.50	9.00		9.00										
OPENING SIZE		EN ISO 12956	µM	120	120	120	110	110	100	90	90	80	70	60	50	50	50	50	50	50	50	50	50	50	40	40	40	40	20	±	30%						
DURABILITY PROPERTIES																																					
WEATHERING RESISTANCE		EN 12224	PASSES EN 12224 WEATHERING TEST. IT IS HIGHLY RECOMMENDED THAT THE GEOTEXTILE IS COVERED WITHIN 30 DAYS FROM THE DAY OF INSTALLATION. THE MATERIAL CAN BE EXPOSED TO SUNLIGHT FOR A MAXIMUM OF 4 MONTHS WITH A DEGRADATION OF THE MECHANICAL PROPERTIES DEPENDING ON SEASON.																																		
PRODUCT COMPOSITION			MADE FROM VIRGIN FIBRE POLYPROPYLENE, UV STABILISED. SPECIFIC WEIGHT OF POLYMER IS 0.91 KG/DM3 . RAW MATERIAL IS STAPLE FIBRES, PRODUCED THROUGH NEEDLEPUNCHING AND CALANDERING. MELTING POINT IS 165-175 °C. FIBRE DIAMETER IS 25-30 µM. THE MATERIAL IS PRODUCED ACCORDING TO THE QUALITY MANAGEMENT SYSTEM OF EN ISO 9001:2008. IT FULFILLS THE REQUIREMENT OF EUROPEAN REGULATIONS RELATED TO CONSTRUCTION PRODUCTS AS PER 1213-CPR 3269.																																		
OXYDATION RESISTANCE		EN ISO 13438																																			

FORECAST MINIMUM DURABILITY OF 25 YEARS FOR EVERY APPLICATION IN NATURAL GROUNDS WITH 4<PH<9 AND SOIL TEMPERATURE <25°C

THE VALUES GIVEN ARE AN AVERAGE OBTAINED IN OUR LABORATORIES AND IN OFFICIAL TESTING INSTITUTES  
 THE CONFIDENCE LEVEL IS 95%  
 WE RESERVE THE RIGHT TO MAKE CHANGES AT ANY TIME WITHOUT NOTICE

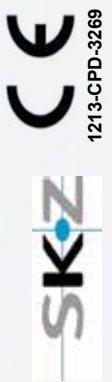

1213-CPD-3269

# PPEXT POLYPROPYLENE NONWOVEN VIRGIN FIBRE FABRIC – SECOND STRENGTH GEOTEXTILE FABRIC

PHYSICAL PROPERTIES		TEST METHOD	UNIT	TOLERANCE															
WEIGHT			G/M <sup>2</sup>	100	120	150	200	250	300	400	500	600	800	1000	1200	1500	±	10%	
THICKNESS		EN ISO 9863-1	MM	0.7	0.8	1.00	1.30	1.60	1.80	2.50	3.30	3.60	4.40	5.50	7.00	8.50	±	20%	
MECHANICAL PROPERTIES																			
TENSILE STRENGTH		MD EN ISO 10319	KN/M	2.0	2.7	3.5	4.5	6.0	9.0	10.0	12.0	18.0	24.0	30.0	35.0	40.0	-	15%	
		CMD EN ISO 10319	KN/M	2.5	3.2	4.0	5.5	8.0	11.0	14.0	18.0	22.0	32.0	40.0	45.0	50.0	-	15%	
ELONGATION AT MAX LOAD		MD EN ISO 10319	%	70	70	70	70	80	80	80	80	80	90	90	95	95	±	25%	
		CMD EN ISO 10319	%	80	80	80	80	85	85	85	90	90	95	100	100	100	±	25%	
ENERGY INDEX		EN ISO 10318	KJ/M <sup>2</sup>	0.8	1.1	1.4	1.9	2.9	4.1	5.0	6.4	8.5	13.3	16.6	19.5	21.9	±	25%	
STATIC PUNCTURE RESISTANCE		EN ISO 12236	KN	0.4	0.5	0.9	0.9	1.3	1.5	1.8	2.5	3.6	4.8	6.0	8.0	10.0	-	10%	
DYNAMIC PUNCTURE RESISTANCE (CONE DROP TEST)		EN ISO 13433	MM	>50	>50	36	28	22	18	14	10	6	2	1	0	0	+	25%	
PYRAMID PUNCTURE RESISTANCE		EN 14574	N	N/A	N/A	N/A	150	200	300	340	400	500	700	1100	1400	1600	-	20%	
HYDRAULIC PROPERTIES																			
PERMEABILITY NORMAL TO THE PLANE		EN ISO 11058	MM/S	110	100	80	70	50	35	25	20	20	20	20	20	20	-	30%	
IN-PLANE FLOW CAPACITY		EN ISO 12958	10-3L/MS	0.6	0.8	1.2	1.8	2.0	2.2	2.6	3.5	4.5	5.3	6.0	6.3	7.0	-	30%	
DURABILITY PROPERTIES																			
WEATHERING RESISTANCE		EN 12224	PASSES EN 12224 WEATHERING TEST. IT IS HIGHLY RECOMMENDED THAT THE GEOTEXTILE IS COVERED WITHIN 15 DAYS FROM THE DAY OF INSTALLATION. THE MATERIAL CAN BE EXPOSED TO SUNLIGHT WITH A DEGRADATION OF THE MECHANICAL PROPERTIES DEPENDING ON SEASON.																
PRODUCT COMPOSITION		MADE FROM POLYPROPYLENE VIRGIN FIBRE. SPECIFIC WEIGHT OF POLYMER IS 0.91 KG/DM <sup>3</sup> . RAW MATERIAL IS STAPLE FIBRES, PRODUCED THROUGH NEEDLE PUNCHING AND CALANDERING. MELTING POINT IS 165-175 °C. THE MATERIAL IS PRODUCED ACCORDING TO THE QUALITY MANAGEMENT SYSTEM OF EN ISO 9001:2008. IT FULFILLS THE REQUIREMENT OF EUROPEAN REGULATIONS RELATED TO CONSTRUCTION PRODUCTS AS PER 1213-CPR 3269.																	
OXYDATION RESISTANCE		EN ISO 13438	FORECAST MINIMUM DURABILITY OF 5 YEARS FOR EVERY APPLICATION IN NATURAL GROUNDS WITH 4<PH<9 AND SOIL TEMPERATURE <25°C																

THE VALUES GIVEN ARE AN AVERAGE OBTAINED IN OUR LABORATORIES AND IN OFFICIAL TESTING INSTITUTES  
 THE CONFIDENCE LEVEL IS 95%  
 WE RESERVE THE RIGHT TO MAKE CHANGES AT ANY TIME WITHOUT NOTICE



1213-CPD-3269



# PEIT RECYCLED POLYESTER – NONWOVEN GEOTEXTILE FABRIC

PHYSICAL PROPERTIES		TEST METHOD	UNIT	TOLERANCE															
WEIGHT			G/M <sup>2</sup>	150	200	250	300	350	400	500	600	700	800	1000	1200	1500	±	10%	
THICKNESS		EN ISO 9863-1	MM	0,90	1,10	1,30	1,60	1,75	1,90	2,20	2,80	3,00	3,50	4,00	4,50	6,00	±	20%	
MECHANICAL PROPERTIES																			
TENSILE STRENGTH		MD EN ISO 10319	KN/M	1,2	1,8	2,0	2,5	2,8	3,2	4,2	5,5	6,0	6,5	7,5	13,0	20,0	-	10%	
		CMD EN ISO 10319	KN/M	1,2	1,8	2,0	2,7	3,2	4,0	5,2	7,5	8,0	9,0	10,5	16,0	25,0	-	10%	
ELONGATION AT MAX LOAD		MD EN ISO 10319	%	50	50	50	50	50	50	60	70	70	80	80	80	80	±	30%	
		CMD EN ISO 10319	%	60	60	60	60	60	60	70	80	80	90	90	90	90	±	30%	
ENERGY INDEX		EN ISO 10318	KJ/M <sup>2</sup>	0,3	0,5	0,6	0,7	0,8	1,0	1,5	2,4	2,6	3,3	3,8	6,2	9,6	±	20%	
STATIC PUNCTURE RESISTANCE		EN ISO 12236	KN	0,2	0,3	0,4	0,5	0,6	0,7	0,8	1,2	1,4	1,8	2,2	2,8	4,0	-	10%	
DYNAMIC PUNCTURE RESISTANCE (CONE DROP TEST)		EN ISO 13433	MM	>50	>50	45	40	30	20	16	6	2	2	0	0	0	+	20%	
PYRAMID PUNCTURE RESISTANCE		EN 14574	N	N/A	N/A	N/A	100	150	180	200	250	270	300	500	700	800	-	20%	
HYDRAULIC PROPERTIES																			
PERMEABILITY NORMAL TO THE PLANE		EN ISO 11058	MM/S	110	100	80	60	50	40	30	25	25	20	20	20	20	-	30%	
IN-PLANE FLOW CAPACITY		EN ISO 12958	10-3L/MS	1,6	2,1	2,3	2,7	3,0	3,2	5,0	7,0	7,0	8,0	9,0	9,0	9,0	-	30%	
OPENING SIZE		EN ISO 12956	µM	65	60	55	55	55	45	45	35	35	35	30	30	30	±	30%	
DURABILITY PROPERTIES																			
WEATHERING RESISTANCE		EN 12224		PASSES EN 12224. IT IS HIGHLY RECOMMENDED THAT THE GEOTEXTILE IS COVERED WITHIN 15 DAYS FROM THE DAY OF INSTALLATION. THE MATERIAL CAN BE EXPOSED TO SUNLIGHT WITH A DEGRADATION OF THE MECHANICAL PROPERTIES DEPENDING ON SEASON.															
PRODUCT COMPOSITION				MADE FROM POLYESTER WHITE FIBRE. SPECIFIC WEIGHT OF POLYMER IS 0.38 KG/DM3 . RAW MATERIAL IS STAPLE FIBRES, PRODUCED THROUGH NEEDLEPUNCHING AND GALANDEERING. THE MATERIAL IS PRODUCED ACCORDING THE QUALITY MANAGEMENT SYSTEM OF EN ISO 9001:2008. IT FULFILLS THE REQUIREMENT OF EUROPEAN REGULATIONS RELATED TO CONSTRUCTION PRODUCTS AS PER 1213-C-PR 3269.															
OXYDATION RESISTANCE		EN ISO 13438		FORECAST MINIMUM DURABILITY OF 5 YEARS FOR EVERY APPLICATION IN NATURAL GROUNDS WITH 4<PH<9 AND SOIL TEMPERATURE <25°C															

THE VALUES GIVEN ARE AN AVERAGE OBTAINED IN OUR LABORATORIES AND IN OFFICIAL TESTING INSTITUTES  
 THE CONFIDENCE LEVEL IS 95%  
 WE RESERVE THE RIGHT TO MAKE CHANGES AT ANY TIME WITHOUT NOTICE



1213-CPD-3269

# PECT MULTI-COLOURED RECYCLED POLYESTER GEOTEXTILE FABRIC

PHYSICAL PROPERTIES		TEST METHOD	UNIT	TOLERANCE															
WEIGHT			G/M <sup>2</sup>	150	200	250	300	350	400	500	600	700	800	1000	1200	1500	±	10%	
THICKNESS		EN ISO 9863-1	MM	1.00	1.20	1.40	1.60	1.80	2.00	2.30	2.60	2.90	3.30	4.00	4.50	6.40	±	20%	
MECHANICAL PROPERTIES																			
TENSILE STRENGTH		MD EN ISO 10319	KN/M	1.0	1.6	2.0	2.4	2.8	3.2	4.0	5.4	6.7	8.0	10.0	12.0	15.0	-	10%	
		CMD EN ISO 10319	KN/M	1.0	1.6	2.1	2.5	3.0	3.4	5.0	7.4	9.0	10.5	13.5	15.0	20.0	-	10%	
ELONGATION AT MAX LOAD		MD EN ISO 10319	%	50	50	50	50	50	50	60	60	70	70	80	80	90	±	30%	
		CMD EN ISO 10319	%	60	60	60	60	60	60	60	60	70	70	80	80	90	±	30%	
ENERGY INDEX		EN ISO 10319	KJ/M <sup>2</sup>	0.3	0.4	0.6	0.7	0.8	0.9	1.4	1.9	2.7	3.2	4.7	5.4	7.9	±	20%	
STATIC PUNCTURE RESISTANCE		EN ISO 12236	KN	0.2	0.3	0.4	0.5	0.6	0.8	1.2	1.8	2.2	2.6	4.2	5.0	6.0	-	10%	
DYNAMIC PUNCTURE RESISTANCE (CONE DROP TEST)		EN ISO 13433	MM	>50	46	40	36	32	24	14	10	8	6	2	2	0	+	20%	
PYRAMID PUNCTURE RESISTANCE		EN 14574	N	N/A	200	300	400	450	500	600	800	950	1100	1500	1700	2000	-	20%	
HYDRAULIC PROPERTIES																			
PERMEABILITY NORMAL TO THE PLANE		EN ISO 11058	MM/S	90	90	70	60	60	50	30	30	25	20	10	10	10	-	30%	
IN-PLANE FLOW CAPACITY		EN ISO 12958	10-3L/MS	2	2	2	3	3	3.2	5	7	7	8	9	9	9	-	30%	
OPENING SIZE		EN ISO 12956	µM	65	60	55	55	55	45	45	35	35	35	30	30	20	±	30%	
DURABILITY PROPERTIES																			
WEATHERING RESISTANCE		EN 12224		PASSES EN 12224. IT IS HIGHLY RECOMMENDED THAT THE GEOTEXTILE IS COVERED WITHIN 15 DAYS FROM THE DAY OF INSTALLATION. THE MATERIAL CAN BE EXPOSED TO SUNLIGHT WITH A DEGRADATION OF THE MECHANICAL PROPERTIES DEPENDING ON SEASON.															
PRODUCT COMPOSITION				MADE FROM MULTICOLOURED POLYESTER RECYCLED FIBRE. SPECIFIC WEIGHT OF POLYMER IS 0.38 KG/DM3 . RAW MATERIAL IS STAPLE FIBRES, PRODUCED THROUGH NEEDLEPUNCHING AND GALANDERING. THE MATERIAL IS PRODUCED ACCORDING THE QUALITY MANAGEMENT SYSTEM OF EN ISO 9001:2008. IT FULFILLS THE REQUIREMENT OF EUROPEAN REGULATIONS RELATED TO CONSTRUCTION PRODUCTS AS PER 1213-CPR 3269.															
OXYDATION RESISTANCE		EN ISO 13438		FORECAST MINIMUM DURABILITY OF 5 YEARS FOR EVERY APPLICATION IN NATURAL GROUNDS WITH 4<PH<9 AND SOIL TEMPERATURE <25°C															

THE VALUES GIVEN ARE AN AVERAGE OBTAINED IN OUR LABORATORIES AND IN OFFICIAL TESTING INSTITUTES  
 THE CONFIDENCE LEVEL IS 95%  
 WE RESERVE THE RIGHT TO MAKE CHANGES AT ANY TIME WITHOUT NOTICE



1213-CPD-3269





**FIXINGS & ANCHORS**

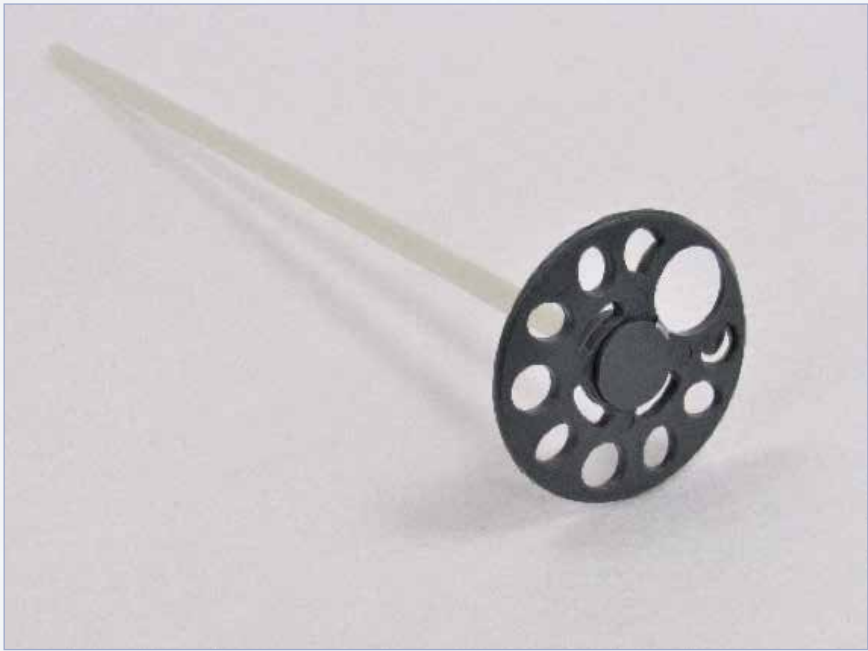



## FIXINGS & ANCHORS

Wallbarn offers a number of fixings and anchors suitable for Protecto-drain and a variety of other sheet membranes. These robust and durable products are designed to help installers create solid fixings when applying sheet material to the horizontal or vertical surface.

These anchors and fixings are hammer fixed. The tension loading of the fixing depends on the type of anchor chosen. They are suitable for fixing insulation boards, plasterboard, ply and plastic sheet membranes to timber and masonry. When fixing to vertical plane it is recommended that 8-12 pieces per m<sup>2</sup> are installed.

The Fixing & Anchor pins comprise a polypropylene sleeve or sheath with an integrated circular flange / washer around the top. There is a separate pin also made from either plastic or metal which penetrates the structure.

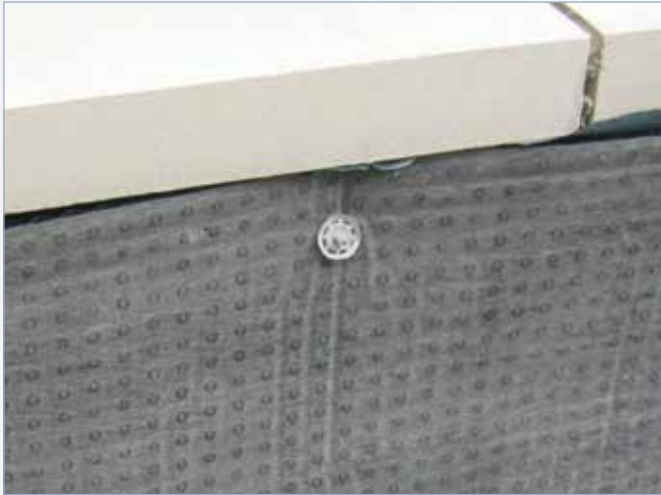

Wallbarn offers two ranges of Fixings & Anchors: the “D Plus range” has a plastic pin and the “D H Range” has a metal pin.

They have different strength and anchoring specifications; which means different codes can be used for different applications. Please review the technical data to be assured the product chosen matches and exceeds the anchoring strength and depth required for the project.



### D PLUS RANGE

This is the standard anchor fixing product. It is designed to be hammered into the structure.

It comprises a plastic sleeve or sheath with a circular flange / washer around the top. There is a separate pin also made from plastic which is driven into the sheath to create the fixing.

The sleeve diameter is 10mm.



### D H RANGE

The D H fixings are also designed to be hammer fixed into the structure.

They are made with a rust-proof metal pin which will give a much firmer fixing into the vertical or horizontal surface.

The sheath and sleeve is made from plastic.

## ACCESSORIES

A cover piece is also available for use with all three ranges above, a simple cover cap with surrounding flange, to dress the fixing area if required. It is made from Impact Resistant Polypropylene.

Wallbarn also sells polystyrene caps and plugs, for where installers need to fill any cavity to prevent water collection or to ensure complete and overall thermal protection. They are available as a circular pad or in a dowel shape to fill the hole created. If they are drilling the fixing anchor into place so that it is flush with the exterior surface but the metal nail fixing enters further, the cavity can be plugged easily with the dowel shaped cap.

## TECHNICAL DATA

### D PLUS RANGE

CODE	DESCRIPTION & SLEEVE DIAMETER / LENGTH OF PIN	
AF-DOWEL-THERM-DPLUS-10/070-Z	FIXING DOWELS THERMOMASTER D PLUS 10/70MM (BOX OF 200)	<p><b>TENSION LOAD IN CONCRETE</b> (NRK, ETAG 014) 0.4KN, ANCHORING DEPTH MIN. 40MM</p> <p><b>TENSION LOAD IN SOLID BRICK</b> (NRK, ETAG 014) 0.4KN, ANCHORING DEPTH MIN. 50MM</p>
AF-DOWEL-THERM-DPLUS-10/090-Z	FIXING DOWELS THERMOMASTER D PLUS 10/90MM (BOX OF 200)	
AF-DOWEL-THERM-DPLUS-10/120-Z	FIXING DOWELS THERMOMASTER D PLUS 10/120MM (BOX OF 200)	
AF-DOWEL-THERM-DPLUS-10/140-Z	FIXING DOWELS THERMOMASTER D PLUS 10/140MM (BOX OF 200)	
AF-DOWEL-THERM-DPLUS-10/160-Z	FIXING DOWELS THERMOMASTER D PLUS 10/160MM (BOX OF 200)	
AF-DOWEL-THERM-DPLUS-10/180-Z	FIXING DOWELS THERMOMASTER D PLUS 10/180MM (BOX OF 200)	
AF-DOWEL-THERM-DPLUS-10/200-Z	FIXING DOWELS THERMOMASTER D PLUS 10/200MM (BOX OF 200)	
AF-DOWEL-THERM-DPLUS-10/220-Z	FIXING DOWELS THERMOMASTER D PLUS 10/220MM (BOX OF 100)	

### D H RANGE

CODE	DESCRIPTION & SLEEVE DIAMETER / LENGTH OF PIN	
AF-DOWEL-THERM-DH-090-Z	FIXING DOWELS THERMOMASTER D-H 90MM (METAL PIN, 200 PIECES)	<p><b>TENSION LOAD IN CONCRETE</b> (NRK, ETAG 014) 0.6KN, ANCHORING DEPTH MIN. 50MM</p> <p><b>TENSION LOAD IN SOLID BRICK</b> (NRK, ETAG 014) 0.4KN, ANCHORING DEPTH MIN. 50MM</p> <p><b>TENSION LOAD IN HOLLOW OR PERFORATED MASONRY</b> (NRK, ETAG 014) 0.3KN, ANCHORING DEPTH MIN. 50MM</p>
AF-DOWEL-THERM-DH-110-Z	FIXING DOWELS THERMOMASTER D-H 110MM (METAL PIN, 200 PIECES)	
AF-DOWEL-THERM-DH-130-Z	FIXING DOWELS THERMOMASTER D-H 130MM (METAL PIN, 200 PIECES)	
AF-DOWEL-THERM-DH-150-Z	FIXING DOWELS THERMOMASTER D-H 150MM (METAL PIN, 200 PIECES)	
AF-DOWEL-THERM-DH-170-Z	FIXING DOWELS THERMOMASTER D-H 170MM (METAL PIN, 200 PIECES)	
AF-DOWEL-THERM-DH-190-Z	FIXING DOWELS THERMOMASTER D-H 190MM (METAL PIN, 200 PIECES)	

## COVER

AF-DOWEL-THERM-COVER-Z	FIXING DOWELS THERMOMASTER COVER (DH & DPLUS, BOX OF 100)
------------------------	---





## IT TOOLS & DESIGN RESOURCES

Wallbarn provides a range of creative tools and resources to help architects, engineers and developers select and include the correct products for the schemes they are designing. A host of services from the Royal Institute of British Architects allows creators to research our products, specify and place them correctly.

Wallbarn hosts its products on the RIBA NBS National BIM (Building Information Modelling) library which allows creators to select objects and “rehearse” them in the project.

BIM objects which are placed into the 3D drawing / simulator include detailed information defining the product’s characteristics and impact on the area it will be installed. The visualisation data gives the object a recognisable appearance and simulates its application. This enables errors and clashes to be resolved in the early stages of the model, saving cost and time.

RIBA Product Selector allows designers to research the product via a digital portal to help with selection of the exact specific model for that part of the project. The NBS Plus tool places the products into the correct clauses on the specification document, so designers can be sure that the correct type and size of product is used at each point.

CAD images via the Fastrack CAD portal, also included on our own website, allow architects to drop the images into their drawings so that they can be manipulated via Autodesk software. Additional information on sizes and accessories is given for all products listed.

Wallbarn offers a number of fully accredited CPDs to help architects understand the products from a design perspective. These presentations help architects to gain points for their own professional development programmes.





## ESB FLOORSYNC

### DECK PLANNING & VISUALISATION SOFTWARE

FloorSync software allows clients to test a colour swatch on their decks and create an image of how the DURO EXCELLENCE deck boards will look on the project area. This gives clients a chance to visualise what the deck space will look like once completed.

A selection of balcony and terrace photos are included in our gallery. For a small fee, users can even send Wallbarn a photograph of the deck area to recreate the exact scheme.

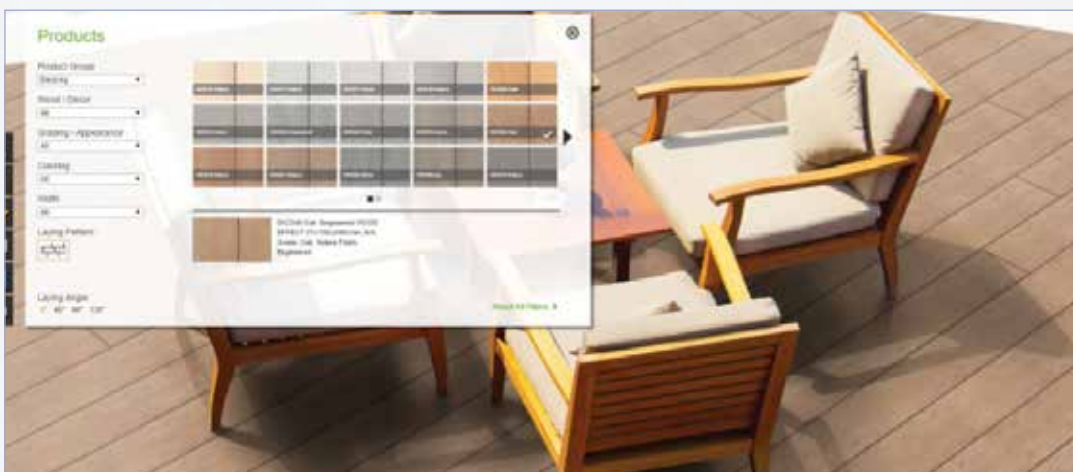
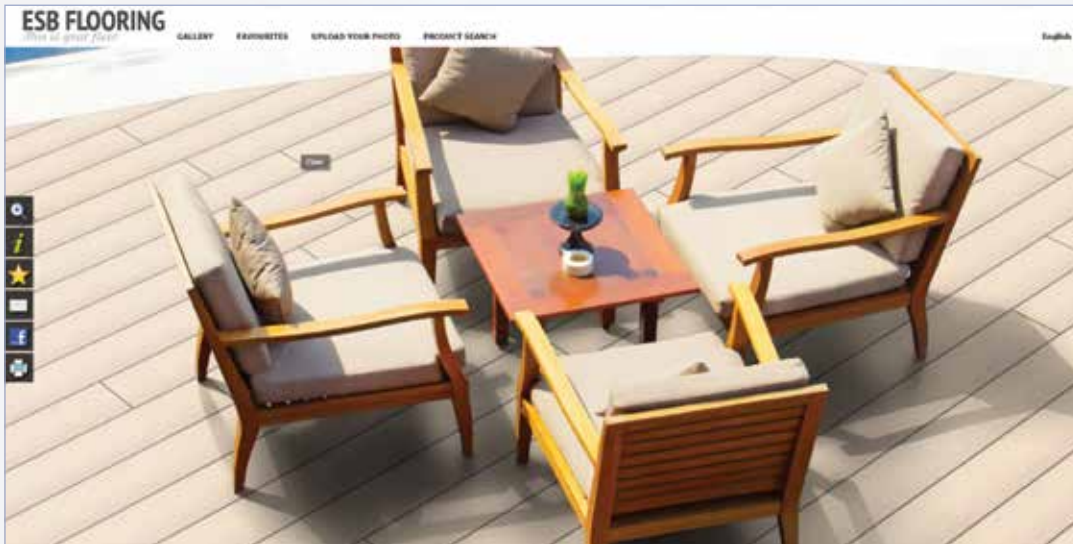

Click the “Floor” icon and a selection of different “DURO EXCELLENCE” colours appears. Select the desired colour and the deck will change colour, giving the user an accurate account of how the project will appear when decked out in DURO EXCELLENCE.

## MEGAPRO SOFTWARE

MegaPro is a new piece of software which accurately estimates the size and quantity of pedestals required for both paving and decking schemes on roofs and terraces. It will calculate the exact number of pedestals required, separate them by height and create a drawing of the exact layout. This drawing will colour code each different height pedestal, creating a user friendly template.

Users should send a PDF drawing to Wallbarn of the deck space. It should include all details of height changes at each point across the roof, position of drainage outlets, slabs sizes / decking centres and any steps or specific details on the roof or terrace.

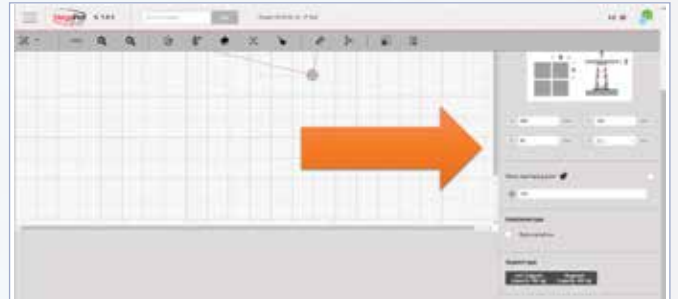
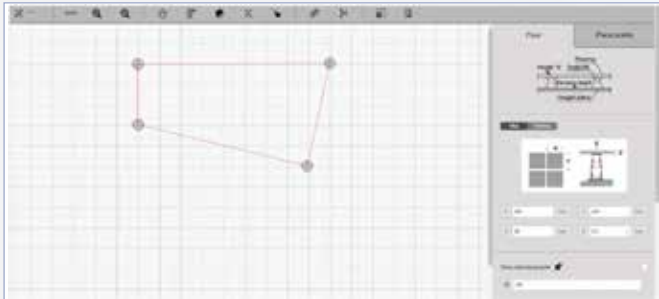

Alternatively, Wallbarn can draw the roof space freehand. We will lay out the edge points and input the details of the slab size and thickness along with the spacing; or in the case of decking, the centres the joist frame will follow.

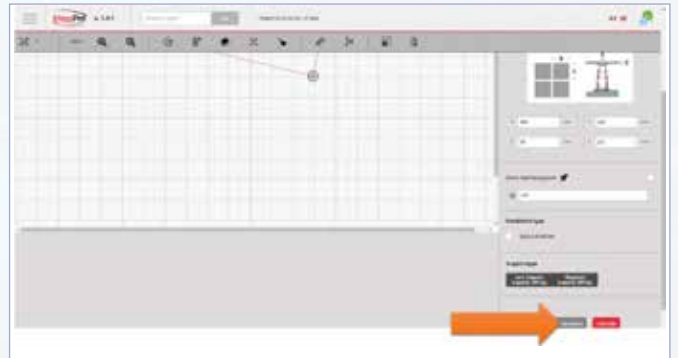

The heights at each point are added and the software calculates the distances (which can be edited if needed). The “calculate” button is pressed and the software lists the exact number and height / product code of each pedestal with slope correctors required to pave across the area, including additional units needed for butting up to parapets.

It places them in the correct place and colour codes each different height across the area to give the reader a blueprint of where each pedestal is located.

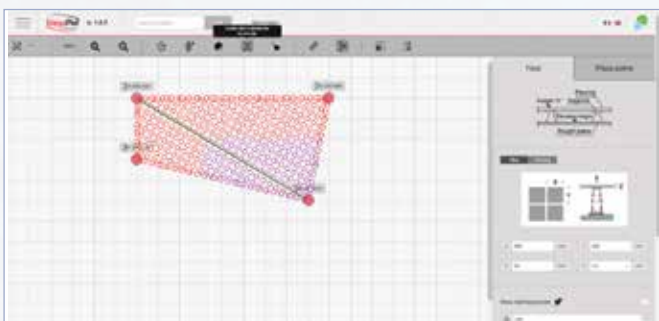

This Bill of Quantities and the visual layout will then be sent to the client along with prices. It will total up the the number of each pedestal height and create a chart and schedule of each product so that the client can cost the project accurately. It can be changed at any point if height thresholds or other aspects of the design change and quantities need to be recalculated.

The visual simulation of the pedestal layout can be used by surveyors and installers, the Bill of Quantities by estimators and purchasers.





## PROJECTS & CASE STUDIES

Some examples of how Wallbarn products have been used successfully on key projects are given in this section.

### VICTORIA DRIVE CARE HOME, WIMBLEDON, LONDON, UK - M-Tray®, EASYCLICK, ASPs, OUTLETS & GEOTEXTILE - 2016



A whole rooftop solution was provided by Wallbarn for this care home project in Wimbledon.

A green roof was required in order to comply with planning rules and the client contacted us with some very tight deadlines.

There were green roof spaces required along with a paved access area on the main roof and a decked terrace on another outdoor space.

Wallbarn supplies mature M-Tray® plant modules from stock so we were able to act quickly. The pedestals and the iDecking EasyClick decking boards are also ex stock.

The sedum plants are mature and established so we were able to provide an instant green roof.

The waterproofed deck was covered with a geotextile fabric as a protection and separation layer. The M-Tray® modules were supplied on pallets and forklifted onto the roof space. The superior connection clips meant that the trays were able to be installed very fast, with the 200m<sup>2</sup> green roof being installed in one day.



The edges of the green roof were surrounded with an aluminium retaining bar to hold everything in place and give an attractive border detail.

The second terrace area was covered with the new iDecking EasyClick composite decking boards, mounted onto Wallbarn pedestals. The ingenious connection fitting meant that installation was extremely fast and there were no visible screws or fixings anywhere on the deck.



The client, Prestige Developments, was working to very tight deadlines and the project was handed over on schedule and in time for the first residents to arrive. The resident will benefit from looking out onto a living green roof space, instead of the bare membrane which remains exposed on many podium decks and flat roofs.



**WOODBURY DOWN, FINSBURY PARK, LONDON, UK – ASP PEDESTALS – 2014**



This residential project is part of a major redevelopment scheme in the Finsbury Park area of north London incorporating private residences and social housing schemes.

ASP pedestals were specified by the architect to hold the paving slabs in an inverted waterproofing system. The suspended slabs were acting as ballast for the insulation and creating attractive and durable hard landscaping spaces on the terraces on these multimillion pound apartments.

They were adjusted in height across these large deck areas to achieve flat paved areas.

This project is part of a major masterplan for redevelopment of the entire area and will create thousands of new homes in both the private and public sector. Wallbarn was chosen as part of the design due to its long track record of supplying high quality adjustable pedestals where we can demonstrate durability and best practice on real projects in the long term.



**SNOWFIELDS SCHOOL, BERMONDSEY, LONDON, UK – TIMBER TILES, ASPs & MINI MEGAPADS – 2015**

This refurbishment project was carried out on a Victorian school building where a usable teaching space was being constructed on the 5th floor roof of the school.

There was an incredibly tight schedule as the project needed to be completed from start to finish within the week long half-term holiday.

The GRP waterproofed deck was made available and the finishes had to be installed in only three days. There was no crane access

and the tight stairwells meant long plank decking could not be used. The 500 x 500 x 30mm hardwood timber tiles had to be carried up five flights of stairs by hand along with the boxes of pedestals.





## WARLINGHAM, SURREY, UK - EASYCLICK FROM IDECKING UK - 2016



This was a private balcony as part of a domestic extension project. The deck had been waterproofed with a GRP membrane which was rigid and hardwearing.

The door threshold was fairly low which made the traditional decking design, i.e. 4 x 2" joists fixed to decking boards, was not possible. The EasyClick overall build-up is only 52mm before pedestals so Wallbarn – who are iDecking UK - was able to offer a solution to the client.

The client had a contemporary theme running through the project and chose the Moor Oak colour to give a subtle and neutral, but at the same time luxury look, to the balcony. The colour did not distract from the view into the garden and blended in well with the glass balustrade.

The contractor used Mini Megapads with a flat head to support the aluminium rails. The Mini Megapads were adjusted in height so that the rails and the boards would be flat. The rails were positioned 35cm apart to give strength to the whole system.



Once the rails were in place and at the correct level, the boards were clicked into place using the ingenious connection design. The underside of the boards have grooves which click into the specially designed clips fixed to the rails. These dart shaped clips hold the rails securely across the 62mm width of the rail. No screws or side fixings are required, giving a smooth, unblemished upper surface.



The boards were installed by simply stamping them down. They line up exactly at right angles to the rails and it is almost impossible to install this system incorrectly as all the connections have been pre-fitted to the precise measurements. The edge facing the balustrade was finished with the Step Profile in Moor Oak and the end appearance was very well received by the client.





## COMMODITY QUAY, ST KATHERINE'S DOCK, LONDON, UK - TDS & ASPs - 2015



This was a major refurbishment and landscaping project for an office development in the City of London.

A podium deck had been re-waterproofed and the area landscaped by contractor Scotscape with a mixture of hard surfaces, grass lawns, planters and borders.

The landscaping contractor used very large joists to hold the decking boards. The Wallbarn TD pedestals are easily capable of supporting the 6 x 2" joists and were adjusted at the stem to provide a flat upper surface.

The timber joists were fixed into a frame, and rigid insulation placed into the cavities between the beams.

The decking boards were fixed to the joists to provide the upper finished surface.



ASP pedestals were also used to support the paved areas on the podium deck. A single seamless surface was achieved across the whole space incorporating both decking and natural stone paving.

## WHITE CITY HOTEL, BAKU, AZERBAIJAN - ASPs - 2014

Wallbarn products had been chosen after a worldwide search for the most suitable products and systems by the architect for this very prestigious project in Azerbaijan.

The ruling family of this state take a very keen interest in all major construction projects in the country and Wallbarn had to present to the Akkord Industry Construction Investment Corporation.

The requirements from the ministry were stringent and comprehensive. The area is subject to vast changes in temperature and being coastal is subject to saline conditions. Wallbarn was able to demonstrate the technical benefits of our products and our track record in supplying top quality assured materials for both private and public sector projects.

The government in Azerbaijan is concerned with its public buildings being constructed only to the very highest standards. Wallbarn was competing against many of the leading brands worldwide and we were chosen over all the competition.

Wallbarn has been specified on a number of upcoming projects in Baku and across the country and we look forward to working with our contractor partners in the future in this very exciting country.





## CATTLE HILL QUARRY, VALE OF YORKSHIRE, UK – M-TRAY® – 2016



The new generation of M-Tray® modules were used on this office building in Poklington, Yorkshire. This project was in the heart of the Vale of Yorkshire, within an Area of Outstanding Natural Beauty and planning sensitivities dictated a green roof was needed on the office building.

The clients wanted the existing farm buildings, which had been converted into offices and storage space, to blend into the hillside with the structures having the very lowest impact on the surrounding countryside.

The timber framed building meant a low weight solution was required so the 100mm deep pre-grown modules were ideal. Installation was carried out within two days by local contractors.

The clients were delighted with the outcome.



## KENNINGTON, LONDON, UK – TIMBER TILES – 2015

This was a private project on a roof terrace in Central London.

The existing terrace had been laid out in plain concrete pressed paving slabs which did not give a very attractive appearance.

The client wanted a more natural finish but with the minimum of disruption, due to the restricted access and lack of scope for rubbish removal. Instead of removing the existing slabs Wallbarn suggested using ASP pedestals and timber tiles made from Brazilian ipe on the area.

The 30mm thick tiles were perfect for overlaying the area as traditional decking would not have fitted within the door threshold. The ASPs were laid onto the concrete flags to a level height, then the timber tiles were loose laid on top to the same level as the interior flooring, achieving a seamless and beautiful finish.





## BIG CHILL, KINGS CROSS, LONDON, UK - ASPS & TDS - 2015



This project was a refurbishment scheme on an existing roof deck in a pub. The roof space had been reinforced and waterproofed and the client wished to put a bar and public area onto the space.

The waterproofing membrane was single ply and the area was very complicated owing to the existing Victorian building being across many levels and interfacing with subsequent extensions with services emerging at irregular intervals.

The designer wanted a mixture of concrete paving and timber decking on the roof terrace and there were a number of services and constructions on it, so it was crucial that the support systems were weight bearing.

The TD and ASP pedestals were ideal across these complicated areas and created a flat, durable leisure area for the pub. The North London clients reported the results as "cool".



## RAINBOW SCHOOL, WANDSWORTH, LONDON, UK - M-TRAY® - 2015

An existing special needs school was looking to have a green roof installed but there was an issue around the disruption the construction process might cause as the school would remain open during the project works. It was essential that the pupils did not come into contact with too much potentially dangerous plant and equipment and the school wished for noise to be kept to a minimum.

The pre-grown, fully established M-Tray® modules could be installed very quickly with the minimum of mess and inconvenience and the whole construction was carried out in two days, whilst the pupils were still occupying the building.

The construction process was relatively straightforward as the roof space was a regular shape and there were only a small number of services and emerging structures to work around.

A clear border on the areas immediately around the rooflights was created to prevent plant growth potentially blocking the light. The space was infilled with stones to help with drainage and prevent the modules moving. The stones also provide a tidy finish.





## WARLINGHAM, SURREY, UK – EASYCHANGE FROM IDECKING UK – 2016



The architect had designed a cantilevered balcony on a hillside residence and wanted the structure to “float” out from the bedroom over the garden. The site was extremely sloping and access was restricted.

The floating balcony was overhanging the lower storey living accommodation and would be viewed from a terrace underneath. The architect was concerned that he did not want too many “workings” being visible from below.

The metal rails were fitted onto the rolled steel joists which were projecting from the main structure. The boards were fitted into place and locked into place using the moveable EasyChange clips. From beneath the rails and boards were visible but were an attractive contrast to the steel joists and gave the whole project a contemporary feel.

The balcony itself was stunning. The boards seemed to float out from the sides of the building into space, as the almost invisible glass balustrade, being at the level of the treetops, extenuated the sense of levitation.

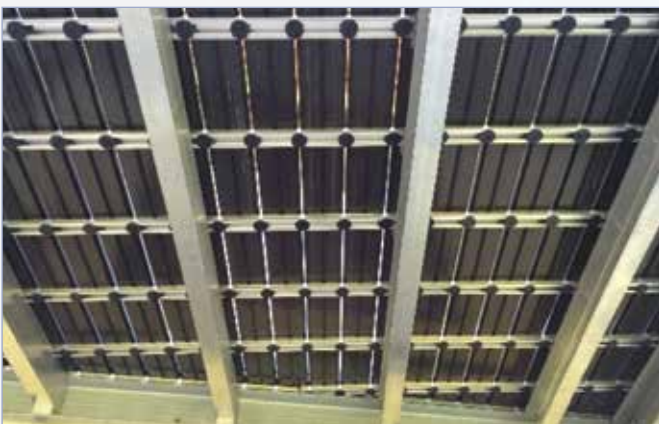

## DEVERE GARDENS, KENSINGTON, LONDON UK – MINI MEGAPADS, ASPS – 2015

This extremely prestigious building, opposite Kensington Palace, was undergoing a full renovation of the Georgian structure and a major extension at the back.

The entire building was owned by the Qatari Royal Family so it was essential that the finishes were very high end. The stone supplier was installing granite slabs to all balcony and terrace areas in an inverted waterproofing scenario.

The stone slabs needed to provide a luxurious finish and also ballast the insulation boards beneath. The paving pattern was also offset on the stretcher-bond so pedestals were required not just on the corners but at every junction between individual slabs.

The balconies were falling in many different directions and the contractor needed the flexibility of the adjustable pedestals in order to get the paving completely flat. Lugs were removed where necessary to adequately support the slabs at the offset junctions. The high end finish required by the client was achieved and they were very pleased with the result.





## OLYMPIC PARK, STRATFORD, LONDON, UK – TD EXTRA & TD EXTRA MOBILE – 2015



Timber decking was being installed onto a flat roof on a building opposite the Olympic Park in Stratford, East London.

In order to match another section of timber decking the clearance from the roof-deck was fairly substantial. The TD Extra pedestals, with extended stem heights of up to 380mm, were selected to give the contractors the scope and flexibility they needed across the entire roof area.

A framework of treated softwood timber joists was constructed, with the timbers being fixed through the sidebars of the TD Mobile heads in order to create a sturdy base structure. The pedestals were not fixed through the membrane as this would compromise the seal.

The pedestals remained freestanding with the decking fixed to the joists to create the walking surface.



## SAFEBAY TOWERS, VANCOUVER, CANADA – M-TRAY® – 2016



The client was a major nursery stock grower in British Columbia, Canada, who had a very large sedum green roof project on a tower block in the city of Vancouver.

The architect was concerned about future-proofing the green roof and wanted to ensure that if there was any problem in the future with the waterproofing seal or any other aspect of the structure, the green roof could be taken up without too much disruption. The decision was taken that a modular solution was the best option.

M-Tray® was included in a worldwide competition to find the most suitable modular design and was judged as the best product available.

Wallbarn supplied the empty M-Tray® units to the grower, who installed them empty on the roof and blew the substrate via a suction machine onto the roof from the ground. Sedum plug plants which had been grown in the client's greenhouses were hand planted into the modules at a rate of 8-10 plants per m<sup>2</sup>.

The whole area was irrigated and fertilized regularly for the first few months until the plants spread to cover the whole area with thick vegetation.





## FORMER LILIAN BAYLISS SCHOOL, KENNINGTON, LONDON, UK - TDS - 2015



This former school was a series of 1960s brutalist style blocks in inner London which had been converted into private apartments.

The apartments all had terraces attached to them and while some were part of the original structure, others were modular design, where the terraces had been constructed offsite and were bolted into the main structure.

Many of the terraces were on different levels and there were many different shapes and designs for the decking installers to contend with.

The beauty of using the Wallbarn TD pedestals to hold the joists for the composite decking areas was that the interface on the deck and the interface with the joists was identical, no matter what size or height of the actual pedestal.

Composite joists were slotted onto the headpieces of the TD supports between the 60mm wide lugs and the decking boards attached to those joists. The decking was fixed to the same height as the door thresholds, giving these expensive apartments luxurious looking terraces.



## RADISSON BLU HOTEL, HEATHROW, LONDON, UK - M-TRAY®



Access was a major issue to this hotel project and a roll-out green roof system was impossible due to the fact that much of the materials had to be moved through the building, a working hotel.

The M-Tray® modules were really the only solution as the planted units could be walked through the lobby where required and hand-balled onto the roof structure.

The easy to fit modules were connected together using the specially designed fittings and the whole green roof was constructed within one day.

The hotel guests, who had previously been overlooking a flat roof with a black bitumen surface, now had a live, growing, green roof to view from their rooms.











**FOR MORE INFORMATION PLEASE CONTACT:**

**WALLBARN LTD**

**UNIT 16, CAPITAL BUSINESS CENTRE • 22 CARLTON ROAD • SOUTH CROYDON • CR2 OBS • UK**

**T: +44 (0)20 8916 2222 • F: +44 (0)20 8916 2223**

**E: [SALES@WALLBARN.COM](mailto:SALES@WALLBARN.COM) • W: [WWW.WALLBARN.COM](http://WWW.WALLBARN.COM)**