

Corotherm Clickfit

DIY Polycarbonate Roof

Easy fit Polycarbonate Roofing Panels

- Simple DIY installation
- Hardwearing and durable
- No specialist tools required
- UV protection
- Lightweight and easy to handle

AVAILABLE IN
A RANGE OF TINTS
RESISTANT TO IMPACT

**10 YEAR
GUARANTEE**

**NO
GLAZING
BARS**



ariel®
the proof's on the roof

www.arielplastics.com

Corotherm Clickfit

DIY Polycarbonate Roof

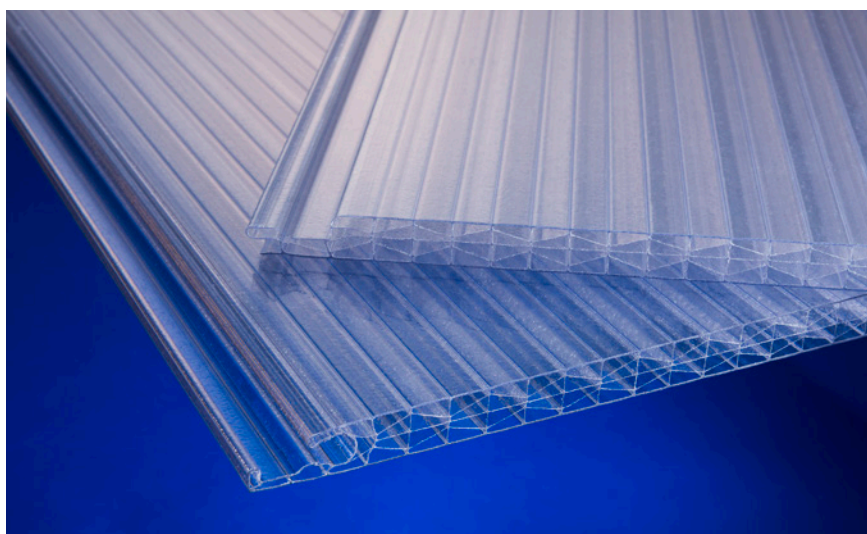
Corotherm Clickfit is an easy fit roofing panel which provides the ideal DIY roofing solution for Verandas, Canopies or Car Ports.



Requiring no glazing bars, the easy fit panels simply click and lock together to provide an instant roof. Perfect for DIY use, only standard tools are required to install. Simply cut panels to the required length, screw into place, click and fit the next panel and repeat, then finish with a U profile.

The panels are manufactured from impact resistant polycarbonate which is hardwearing, durable and long-lasting. This super clear sheet has added UV protection so that you can enjoy the great outdoors whilst being protected from the harmful effects of the sun.

| Code | Item Description |
|-------|--|
| 83001 | Corotherm Clickfit Polycarb Sheet 16mm x 3000mm x 500m Clear |
| 83011 | Corotherm Clickfit Polycarb Sheet 16mm x 3000mm x 500m Opal |
| 83031 | Corotherm Clickfit F-Profile Aluminium 16mm x 3m |
| 83041 | Corotherm Clickfit U-Profile Aluminium 16mm x 3m |
| 83051 | Corotherm Clickfit Channel Washer |
| BMNO | 10/16mm Aluminium Sealing Tape 38mm x 10m |
| BSTP | 10/16mm Breather Tape 38mm x 10m |
| 76590 | Low Modulus Silicone Sealant 310ml White |

Key Benefits

- Easy to handle
- Light in weight
- Speedy assembly
- Very strong
- Impact resistant
- UV protected

Applications

- Carports
- Pool covers
- Canopies
- Veranda covers
- Patio covers
- Lean-tos

Clickfit Components

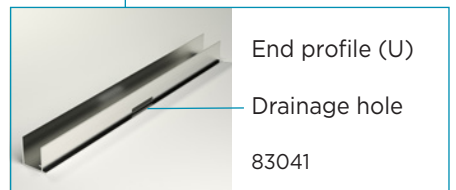
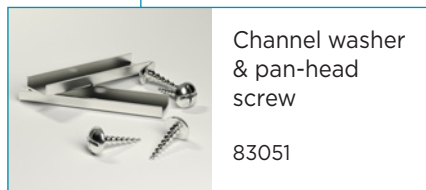
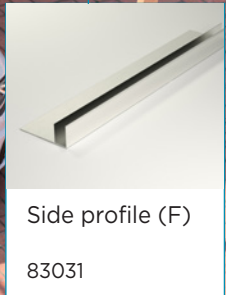
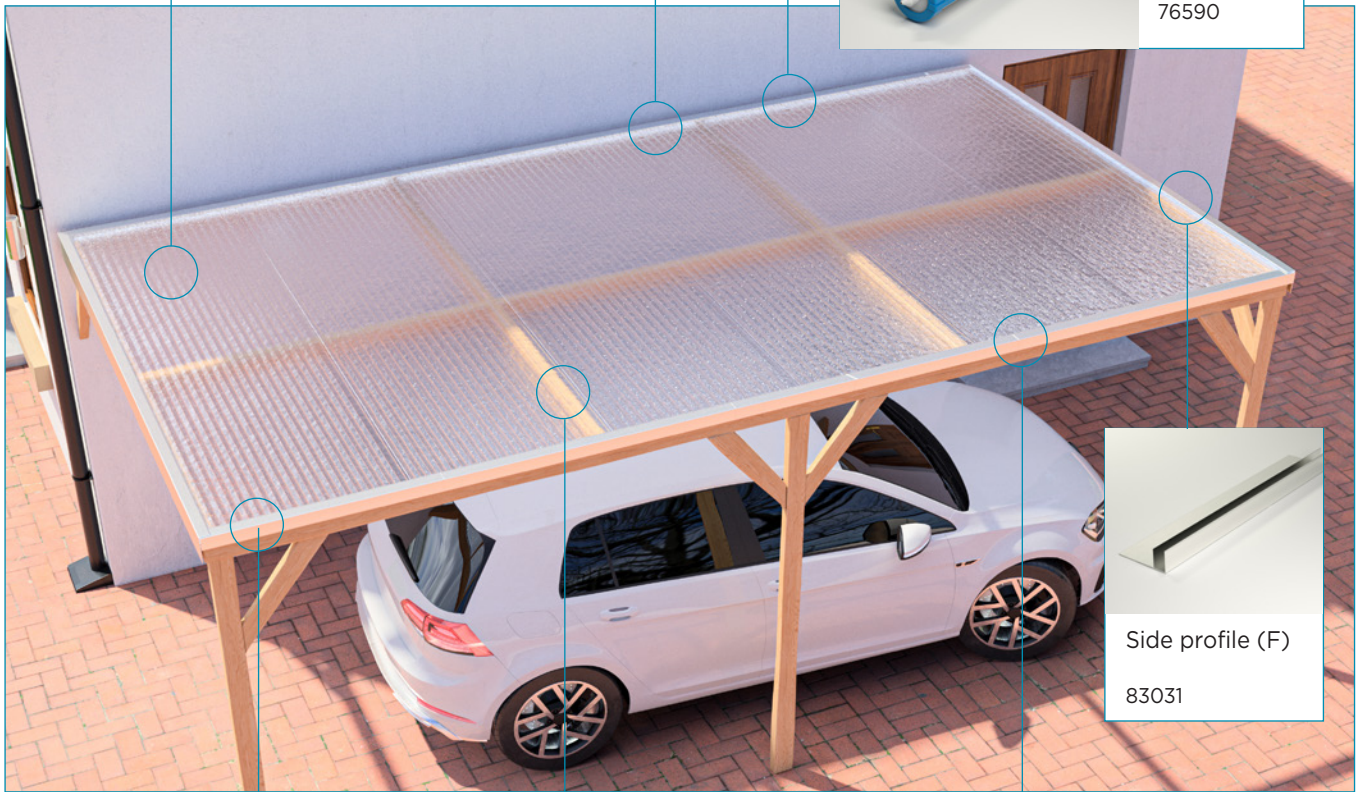
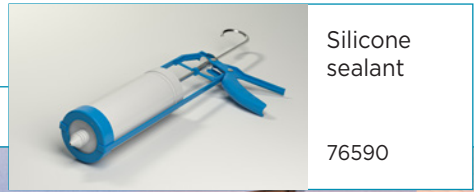
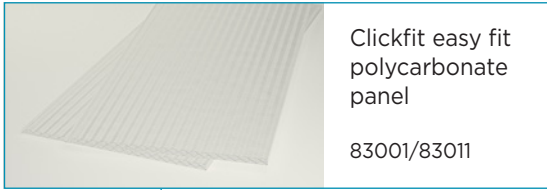
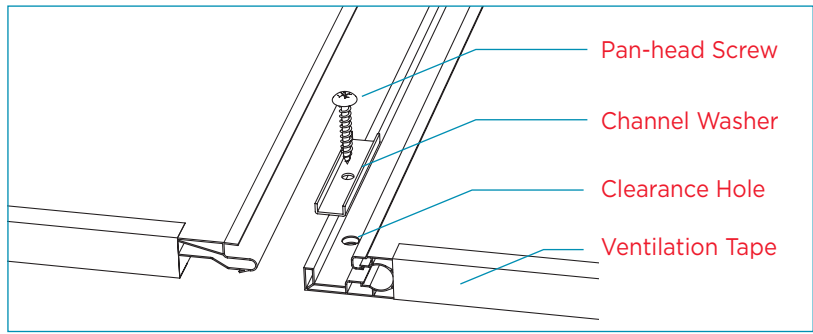

Corotherm Clickfit

UV PROTECTION

Marlon Clickloc has a coextruded UV protection layer on one side.

WARRANTY

There is 10 year limited warranty against loss of light transmission, yellowing and weather impact available for this product.

QUALITY

Manufactured under ISO 9001: 2015.

HANDLING & SAFETY

Do not step directly on the rooflight. Use stepping boards. Work according to local safety regulations.

STORAGE

Store in a shaded place, protect from direct sunlight and rain prior to installation. Avoid covering the sheets with heat absorbing materials. Avoid contact with chemicals. Protect the sheets from physical damage.

RECOMMENDATIONS

Minimum roof slope 5° /
Maximum sheet length 4.5m

INSTALLATION

Make adequate allowance for thermal movement, nominally 3.5mm per metre. Holes drilled for fixings must be oversized. Sheet lengths must be limited to en-sure there is no excessive movement at the end laps or fixings.

Do not overtighten fixings. Remove protective film on installation.

SERVICE TEMPERATURE

For stable prolonged service ranging from -20°C to 100°C. (Short term un-stressed -40°C to 130°C).

MAINTENANCE

In order to maintain this product in good condition it should be cleaned periodically using suitable detergent cleaning agents. Do not use solvent cleaners. Do not scrub with brushes or sharp implements. Avoid cleaning in hot sun or high temperatures.

Properties

| | |
|---------------|-----------------------|
| Thickness | 16mm |
| Cover Width | 500mm |
| U-value | 2.0W/m ² K |
| UV protection | Single sided |

Light Transmission

| Colour | Light | Solar |
|------------------|-------|-------|
| Clear | 66% | 69% |
| Bronze | 14% | 42% |
| Pearlescent (PW) | 59% | 39% |

Spanning

| Purlin Centres (mm) | Load (N/m ²) |
|---------------------|--------------------------|
| 800 | 1000 |
| 1000 | 750 |
| 1200 | 500 |

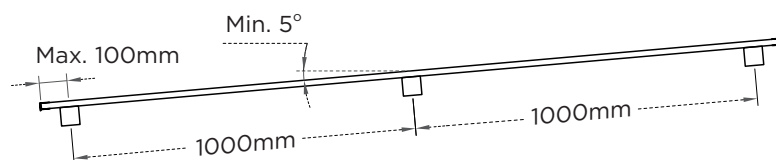

Speedwell Industrial Estate
Staveley
Derbyshire
S43 3JP

Tel: 01246 281111
Fax: 01246 561111
Email: info@arielplastics.com

Orderline email: sales@arielplastics.com

www.arielplastics.com



Q09125

All reasonable care has been taken in the compilation of the information contained within this brochure. Ariel Plastics reserves the right to amend specifications and prices without prior notice. All recommendations on the use of our products are made without guarantee as conditions of use are beyond the control of Ariel Plastics. It is the customer's responsibility to ensure that the product is fit for its intended purpose and that the actual conditions of use are suitable.