



DRAPER[®]

230V 15L WET & DRY

VACUUM CLEANER

90107



These instructions accompanying the product are the original instructions. This document is part of the product, keep it for the life of the product passing it on to any subsequent holder of the product. Read all these instructions before assembling, operating or maintaining this product.

This manual has been compiled by Draper Tools describing the purpose for which the product has been designed, and contains all the necessary information to ensure its correct and safe use. By following all the general safety instructions contained in this manual, it will ensure both product and operator safety, together with longer life of the product itself.

All photographs and drawings in this manual are supplied by Draper Tools to help illustrate the operation of the product.

Whilst every effort has been made to ensure the accuracy of information contained in this manual, the Draper Tools policy of continuous improvement determines the right to make modifications without prior warning.

1. TITLE PAGE

1.1 INTRODUCTION:

USER MANUAL FOR: 230V 15L WET & DRY VACUUM CLEANER

Stock No: 90107

Part No: WDV15P

1.2 REVISIONS:

Date first published February 2019.

As our user manuals are continually updated, users should make sure that they use the very latest version.

Downloads are available from: <http://drapertools.com/manuals>

Draper Tools Limited
Hursley Road
Chandler's Ford
Eastleigh
Hampshire
SO53 1YF
UK

Website: drapertools.com

Product Helpline: +44 (0) 23 8049 4344

General Fax: +44 (0) 23 8026 0784

1.3 UNDERSTANDING THIS MANUALS SAFETY CONTENT:

WARNING! – Information that draws attention to the risk of injury or death.

CAUTION! – Information that draws attention to the risk of damage to the product or surroundings.

1.4 COPYRIGHT © NOTICE:

Copyright © Draper Tools Limited.

Permission is granted to reproduce this publication for personal and educational use only. Commercial copying, redistribution, hiring or lending is prohibited.

No part of this publication may be stored in a retrieval system or transmitted in any other form or means without written permission from Draper Tools Limited.

In all cases this copyright notice must remain intact.

2. CONTENTS

2.1 CONTENTS

Page content	Page
1 TITLE PAGE	
1.1 INTRODUCTION	2
1.2 REVISION HISTORY	2
1.3 UNDERSTANDING THIS MANUAL	2
1.4 COPYRIGHT NOTICE	2
2 CONTENTS	
2.1 CONTENTS	3
3 GUARANTEE	
3.1 GUARANTEE	4
4 INTRODUCTION	
4.1 SCOPE	5
4.2 SPECIFICATION	5
4.3 HANDLING & STORAGE	5
5 HEALTH & SAFETY INFORMATION	
5.1 GENERAL SAFETY INSTRUCTIONS FOR POWER TOOL USE	6-7
5.2 CONNECTION TO THE POWER SUPPLY	7
6 TECHNICAL DESCRIPTION	
6.1 IDENTIFICATION	8
7 UNPACKING & CHECKING	
7.1 PACKAGING	9
8 PREPARING THE VACUUM CLEANER	
8.1 CONNECTING THE CASTORS	10
9 SETTING THE VACUUM CLEANER	
9.1 CHANGING SETUP FROM WET TO DRY VACUUMING	11
9.2 ATTACHING THE CLOTH FILTER	11
9.3 ATTACHING THE PAPER DUSTBAG	11
9.4 REFIT OF MOTOR HOUSING	12
9.5 CONNECTING THE FLEXIBLE HOSE	12
9.6 USE OF ATTACHMENTS	12
9.7 SWITCHING ON	13
9.8 CHANGING SETUP FROM DRY TO WET VACUUMING	13
9.9 WATER LEVEL	13
9.10 BLOWER MODE	14
10 MAINTENANCE	
10.1 MAINTENANCE	15
11 TROUBLESHOOTING	
11.1 TROUBLESHOOTING	15
12 EXPLANATION OF SYMBOLS	
12.1 EXPLANATION OF SYMBOLS	16
13 DISPOSAL	
13.1 DISPOSAL	17
14 OPTIONAL ACCESSORIES	
14.1 ACCESSORIES	18
DECLARATION OF CONFORMITY	ENCLOSED

3. GUARANTEE

3.1 GUARANTEE

Draper tools have been carefully tested and inspected before shipment and are guaranteed to be free from defective materials and workmanship.

Should the tool develop a fault, please return the complete tool to your nearest distributor or contact Draper Tools Limited, Chandler's Ford, Eastleigh, Hampshire, SO53 1YF. England.

Telephone Sales Desk: (023) 8049 4333 or Product Helpline (023) 8049 4344.

A proof of purchase must be provided with the tool.

If upon inspection it is found that the fault occurring is due to defective materials or workmanship, repairs will be carried out free of charge. This guarantee period covering parts/labour is 12 months from the date of purchase except where tools are hired out when the guarantee period is 90 days from the date of purchase. The guarantee is extended to 24 months for parts only. This guarantee does not apply to normal wear and tear, nor does it cover any damage caused by misuse, careless or unsafe handling, alterations, accidents, or repairs attempted or made by any personnel other than the authorised Draper warranty repair agent.

Note: If the tool is found not to be within the terms of warranty, repairs and carriage charges will be quoted and made accordingly.

This guarantee applies in lieu of any other guarantee expressed or implied and variations of its terms are not authorised.

Your Draper guarantee is not effective unless you can produce upon request a dated receipt or invoice to verify your proof of purchase within the guarantee period.

Please note that this guarantee is an additional benefit and does not affect your statutory rights. Draper Tools Limited.

4. INTRODUCTION

4.1 SCOPE

Stainless steel tank vacuum cleaner. Designed to pickup wet and dry materials. Ideally suited for use in the workshop and garage or DIY work around the home.

4.2 SPECIFICATION

Stock no.	90107
Part no.	WDV15P
Rated voltage	230V~50Hz
Rated input	1250W
Tank volume	15L
Vacuum pressure	21Kpa (210mbar)
Max. airflow	25L/sec
Sound pressure level*	86dB(A)
Weight (gross)	5.6kg

* *Continuous A-Weighted Sound Pressure Level at the workstation in accordance to and declared according to EN60745.*

4.3 HANDLING & STORAGE

Although this machine is small in size, care must still be taken when handling and lifting. Dropping this machine will have an effect on the accuracy and may also result in personal injury. This machine is not a toy and must be respected.

The environment will have a negative result on its operation if you are not careful. If the air is damp, components will rust. If the machine is unprotected from dust and debris; components will become clogged: And if not cleaned and maintained correctly or regularly the machine will not perform at its best.

5. HEALTH & SAFETY INFORMATION

5.1 GENERAL SAFETY INSTRUCTIONS FOR POWER TOOL USE

When using any type of power tool there are steps that should be taken to make sure that you, as the user, remain safe.

Common sense and a respect for the tool will help reduce the risk of injury.

Read the instruction manual fully. Do not attempt any operation until you have read and understood this manual.

Most important you must know how to safely start and stop this machine, especially in an emergency.

Keep the work area tidy and clean. Attempting to clear clutter from around the machine during use will reduce your concentration. Mess on the floor creates a trip hazard. Any liquid spilt on the floor could result in you slipping.

Find a suitable location. If the machine is bench mounted; the location should provide good natural light or artificial lighting as a replacement. Avoid damp and dust locations as it will have a negative effect on the machine's performance.

If the machine is portable; do not expose the tool to rain. In all cases do not operate power tools near any flammable materials.

Beware of electric shock. Avoid contact with earthed surfaces; because they can conduct electricity if there is an electrical fault with the power tool. Always protect the power cable and route it away from danger.

Keep bystanders away. Children, onlookers and passers by must be restricted from entering the work area for their own protection. The barrier must extend a suitable distance from the tool user.

Unplug and house all power tools that are not in use. A power tool should never be left unattended while connected to the power supply. They must be housed in a suitable location, away locked up and from children.

Do not overload or misuse the tool. All tools are designed for a purpose and are limited to what they are capable of doing. Do not attempt to use a power tool (or adapt it in any way) for an application it is not designed for. Select a tool appropriate for the size of the job. Overloading a tool will result in tool failure and user injury: This covers the use of accessories.

Dress properly. Loose clothing, long hair and jewellery are all dangerous because they can become entangled in moving machinery: This can also result in parts of body being pulled into the machine. Clothing should be close fitted, with any long hair tied back and jewellery and neck ties removed. Footwear must be fully enclosed and have a nonslip sole.

Wear personal protective equipment (PPE). Dust, noise, vibration and **swarf** can all be dangerous if not suitably protected against. If the work involving the power tool creates dust or fumes; wear a dust mask. Vibration to the hand, caused by operating some tools for longer periods must be protected against. Wear vibration reducing gloves and allow long breaks between uses. Protect against dust and **swarf** by wearing approved safety goggles or a face shield. These are some of the more common hazards and preventions; however, always find out what hazards are associated with the machine/work process and wear the most suitable protective equipment available.

Do not breathe contaminated air. If the work creates dust or fumes; connect the machine (if possible) to an extraction system either locally or remotely. Working outdoors can also help if possible.

Move the machine as instructed. If the machine is hand held, do not carry it by the power supply cable. If the product is heavy; employ a second or third person to help move it safely or use a mechanical device. Always refer to the instructions for the correct method.

Do not overreach. Extending your body too far can result in a loss of balance and you falling. This could be from a height or onto a machine and will result in injury.

Maintain your tools correctly. A well maintained tool will do the job safely. Replace any damaged or missing parts immediately with original parts from the manufacturer. As applicable; keep blades sharp; moving parts clean, oiled or greased; handles clean; and emergency devices working.

5. HEALTH & SAFETY INFORMATION

Wait for the machine to stop. Unless the machine is fitted with a safety brake; some parts may continue to move due to momentum. Wait for all parts to stop; then unplug it from the power supply before making any adjustments, carrying out maintenance operations or just finishing using the tool.

Remove and check setting tools. Some machinery requires the use of additional tools or keys to set, load or adjust the power tool. Before starting the power tool always check to make certain they have been removed and are safely away from the machine.

Prevent unintentional starting. Before plugging any machine in to the power supply, make sure the switch is in the OFF position. If the machine is portable; do not hold the machine near the switch and take care when putting the machine down; that nothing can operate the switch.

Carefully select an extension lead. Some machines are not suitable for use with extension leads. If the tool is designed for use outdoors; use an extension lead also suitable for that environment. When using an extended lead, select one capable of handling the current (amps) drawn by the machine in use. Fully extend the lead regardless of the distance between the power supply and the tool. Excess current (amps) and a coiled extension lead will both cause the cable to heat up and can result in fire.

Concentrate and stay alert. Distractions are likely to cause an accident. Never operate a power tool if you are under the influence of drugs (prescription or otherwise), including alcohol or if you are feeling tired. Being disorientated will result in an accident.

Have this tool repaired by a qualified person. This tool is designed to conform to the relevant international and local standards and as such should be maintained and repaired by someone qualified; using only original parts supplied by the manufacturer: This will ensure the tool remains safe to use.

Specific safety instructions for vacuum cleaner use.

This appliance can be used by children aged from 8 years and above and persons with reduced physical, sensory or mental capabilities or lack of experience and knowledge if they have been given supervision or instruction concerning use of the appliance in a safe way and understand the hazards involved. Children shall not play with the appliance. Cleaning and user maintenance shall not be made by children without supervision.

5.2 CONNECTION TO THE POWER SUPPLY

Make sure the power supply information on the machine's rating plate are compatible with the power supply you intend to connect it to.

These vacuum cleaners come supplied with a UK standard 3 pin plug fitted. It is designed for connection to a domestic power supply rated at 230V AC.

Apart from replacing the fuse in the plug, no other electrical work is recommended on this product.

CAUTION: Risk of electric shock. Do not open.

This appliance is supplied with a moulded 3 pin mains plug for your safety. The value of the fuse fitted is marked on the pin face of the plug. Should the fuse need replacing, ensure the substitute is of the correct rating, approved to BS1362 and ASTA or BS Kite marked.

ASTA 
BSI

The fuse cover is removable with a small plain slot screwdriver. Ensure the fuse cover is replaced before attempting to connect the plug to an electrical outlet. If the cover is missing, a replacement must be obtained or the plug replaced with a suitable type.

If a replacement plug is to be fitted this must be carried out by a qualified electrician.

The damaged or incomplete plug, when cut from the cable shall be disabled to prevent connection to a live electrical outlet.

This appliance is Class II[†] and is designed for connection to a power supply matching that detailed on the rating label and compatible with the plug fitted.

If an extension lead is required, use an approved and compatible lead rated for this appliance. Follow all the instruction supplied with the extension lead.

[†]Double insulated : This product requires no earth connection as supplementary insulation is applied to the basic insulation to protect against electric shock in the event of failure of the basic insulation.

Draper Tools recommend that this vacuum is used with a residual current device (RCD),
Draper Stock No.69307.

6. TECHNICAL DESCRIPTION

6.1 IDENTIFICATION



- ① On/off switch
- ② Carrying handle
- ③ Blowing function (rear of machine)
- ④ Motor/pump housing

- ⑤ Retaining clips
- ⑥ Tank
- ⑦ Accessory holders

7. UNPACKING & CHECKING

7.1 PACKAGING

Carefully remove the vacuum cleaner from the packaging and examine it for any sign of damage that may have happened during shipping. Lay the contents out and check them against the parts shown below. If any part is damaged or missing; please contact the Draper Helpline (the telephone number appears on the Title page) and do not attempt to use the cleaner.

The packaging material should be retained at least during the guarantee period: in case the machine needs to be returned for repair.

Warning! Some of the packaging materials used may be harmful to children. Do not leave any of these materials in the reach of children.

If any of the packaging is to be thrown away, make sure they are disposed of correctly; according to local regulations.

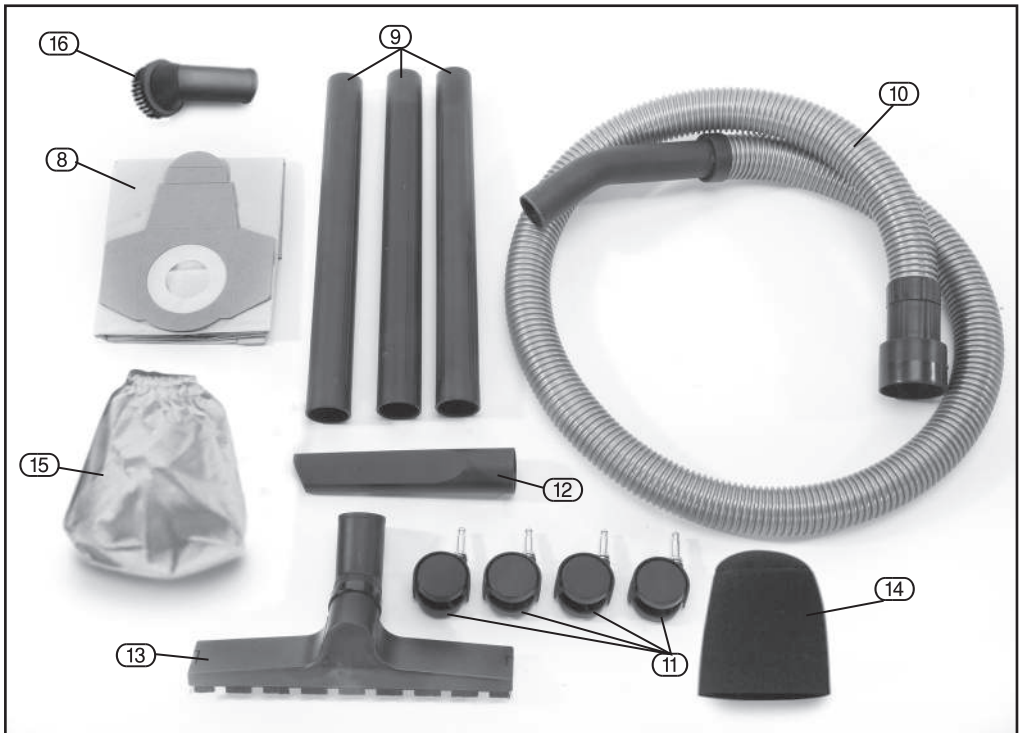

- (8) Paper dust bag
- (9) Extension tubes x 3
- (10) Flexible hose
- (11) Castors x 4
- (12) Crevice attachment

- (13) Double function brush
(floors/liquids accessory)
- (14) Foam filter
- (15) Cloth filter
- (16) Round brush

8. PREPARING THE VACUUM CLEANER

8.1 CONNECTING THE CASTORS - FIG. 1

Firmly press the castors (11) into the base of the tank.

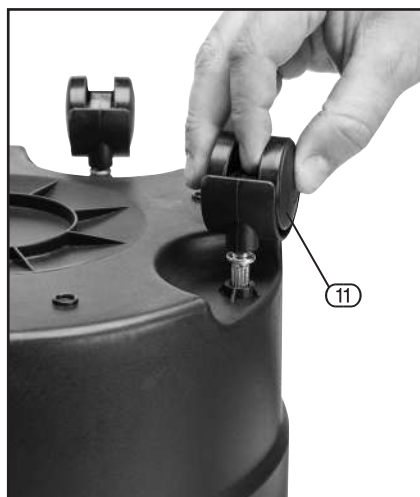

FIG. 1

9. SETTING THE VACUUM CLEANER

9.1 CHANGING SETUP FROM WET TO DRY VACUUMING - FIG. 2

Empty the tank and dispose of any liquid which may have been picked up previously.

Remove the foam filter (14) (if fitted).

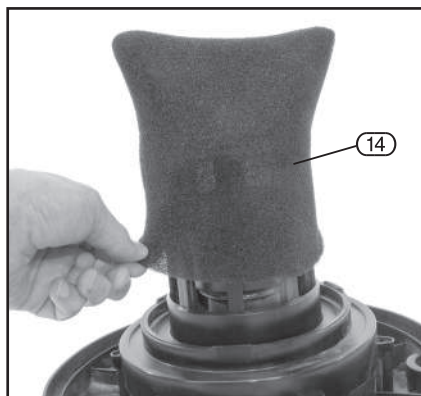

FIG. 2

9.2 ATTACHING THE CLOTH FILTER - FIG. 3

Placing it beneath the motor, the cloth filter (15) must now be fitted by pushing it on.



FIG. 3

9.3 ATTACHING THE PAPER DUSTBAG - FIG. 4

Fix the paper dustbag (8) to the inner side of the hose connector in the tank as shown. When using the paper dust bag, dirt can be removed more hygienically.

Note: As suction power decreases, replace the paper dustbag with a new one.



FIG. 4

9. SETTING THE VACUUM CLEANER

9.4 REFIT OF MOTOR HOUSING - FIG. 5

The motor housing is secured using the two retaining clips (5).



FIG. 5

9.5 CONNECT THE FLEXIBLE HOSE - FIG. 6

Push the flexible hose (10) into the connector, turn anti-clockwise to lock. To remove the flexible hose, twist hose clockwise and pull.



FIG. 6

9.6 USE OF ATTACHMENTS - FIG. 7

The combination attachment (13) to be used on hard floors, parquet, cork, vinyl, ceramic, etc. Any of the other attachments may be used depending upon the specific application. They are attached in the same way as explained previously.

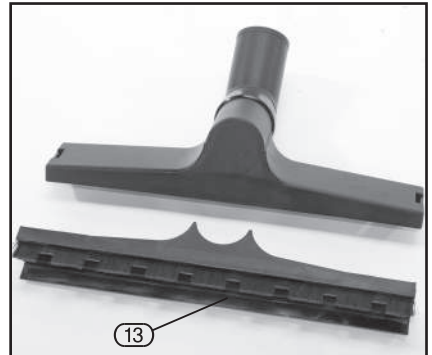

FIG.7

9. SETTING THE VACUUM CLEANER

9.7 SWITCHING ON - FIG. 8

Now connect the vacuum cleaner to the power supply and switch the vacuum cleaner 'ON' by pushing the switch "I".

Now use the vacuum cleaner as normal.

WARNING: EXPLOSION AND FIRE HAZARD.

Never vacuum asbestos, inflammable fluids, such as petrol, oil, solvents, etc. Do not operate near inflammable fluids or gas. Never vacuum fluids or material hotter than 60°C, such as burning cigarettes, ashes, glowing coals, etc.

If cable becomes damaged, replace immediately.

Always keep the cloth filter clean for maximum performance.



FIG. 8

9.8 CHANGING SETUP FROM DRY TO WET VACUUMING - FIG. 9

Empty the tank and dispose of any dirt/dust which may have been picked up previously.

Remove the cloth filter if fitted.

Now fit the foam filter (14). This slides over the float cage as shown.

NEVER VACUUM DRY DUST AND DIRT WITH THIS FILTER FITTED AS IT WILL PROVIDE LITTLE OR NO PROTECTION RESULTING IN MOTOR DAMAGE.

Refit the motor housing by securing with the two retaining clips.

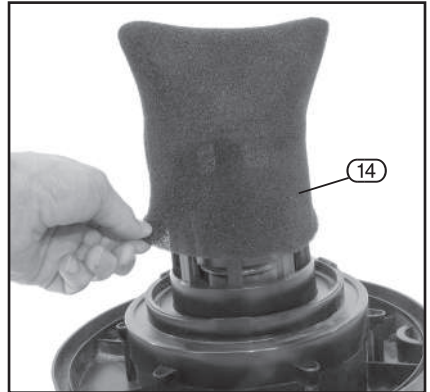

FIG. 9

9.9 WATER LEVEL - FIG. 10

Note: The crevice nozzle should be used when the water level is too high to use attachment.

To ensure the air flow is adequate, we recommend that the end of the nozzle is not totally immersed.

When the fluids have reached the highest permissible level in the tank, the float regulator (4.1) will cover the motor air inlet causing the motor to work harder, it will become noisier, at this point turn off and empty the tank.

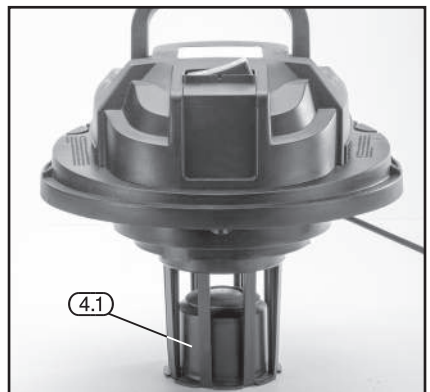

FIG. 10

9. SETTING THE VACUUM CLEANER

9.10 BLOWER MODE - FIG. 11

This machine can also be used as a blower by attaching the hose to the motor outlet when in dry vacuum mode. If using to inflate items, care must be taken to avoid over-inflation. Remove bag before using.



FIG. 11

10. MAINTENANCE

10.1 MAINTENANCE

Regular inspection and cleaning reduces the necessity for maintenance operations and will keep your tools in good working condition.

The motor must be correctly ventilated during the tools operation. For this reason avoid blocking the air inlets.

If the replacement of the supply cord is necessary, this has to be done by the manufacturer or his agent in order to avoid a safety hazard.

Remove the plug from the socket before carrying out adjustment, servicing or maintenance.

11. TROUBLESHOOTING

11.1 TROUBLESHOOTING

WARNING: For your own safety, turn the switch off and remove the plug from the power supply socket.

PROBLEM	POSSIBLE CAUSE	REQUIRED ACTION
<ul style="list-style-type: none">• Vacuum will not operate.	<ul style="list-style-type: none">• No power supply.• Faulty power cord.• Container full of liquid.	<ul style="list-style-type: none">• Check power supply - cord, breakers, fuses.• Check the power cord and repair it or replace it if necessary.• Empty container.
<ul style="list-style-type: none">• Dust comes from motor cover.	<ul style="list-style-type: none">• The cloth filter is missing or damaged.	<ul style="list-style-type: none">• Attach or replace cloth filter.
<ul style="list-style-type: none">• Reduced efficiency and motor/speed vibration..	<ul style="list-style-type: none">• There is a blockage in the nozzle, the hose, or the container inlet, or the cloth filter is blocked by fine dust.	<ul style="list-style-type: none">• Check the nozzle, the hose, and the container inlet for blockage. Take off the cloth filter, and wash and clean it. Reuse it when it is dry. It is recommended to use a new cloth filter.

IMPORTANT: Please note all repairs/service should be carried out by a qualified person.

12. EXPLANATION OF SYMBOLS

12.1 EXPLANATION OF SYMBOLS



Warning!
Read the instruction manual



For indoor use.
Do not expose to rain.



Warning!
Wear suitable eye/face protection.



Class II construction
(Double insulated)



Warning!
Wear suitable respiratory protection.



WEEE
Do not dispose of Waste Electrical &
Electronic Equipment in with domestic
rubbish



Warning!
Wear suitable ear protection.

13. DISPOSAL

13.1 DISPOSAL

- At the end of the machine's working life, or when it can no longer be repaired, ensure that it is disposed of according to national regulations.
- Contact your local authority for details of collection schemes in your area.

In all circumstances:

- Do not dispose of power tools with domestic waste.
- Do not incinerate.
- Do not abandon in the environment.
- Do not dispose of WEEE* as unsorted municipal waste.



* Waste Electrical & Electronic Equipment.

14. OPTIONAL ACCESSORIES

14.1 ACCESSORIES

Stock No.	Part No.	Accessory
67794	AWDVSS-43	Tube
67812	AWDVSS-44	Hose
67818	AWDVSS-45	Filter foam
67819	AWDVSS-46	Wet brush
67999	AWDVSS-47	Crevice tool
68015	AWDVSS-48	Paper bag x3
68049	AWDVSS-49	Cloth filter
68301	AWDVSS-50	Round brush

CONTACTS

Draper Tools Limited, Hursley Road,
Chandler's Ford, Eastleigh, Hampshire. SO53 1YF. U.K.

Helpline: (023) 8049 4344

Sales Desk: (023) 8049 4333

Internet: drapertools.com

E-mail: sales@drapertools.com

General Enquiries: (023) 8026 6355

Service/Warranty Repair Agent:

For aftersales servicing or warranty repairs, please contact the
Draper Tools Helpline for details of an agent in your local area.

YOUR DRAPER STOCKIST

JLCM0219

©Published by Draper Tools Limited.

No part of this publication may be reproduced, stored in a retrieval system or transmitted in any form or by any means, electronic, mechanical photocopying, recording or otherwise without prior permission in writing from Draper Tools Ltd.