

PROFILED SHEETING

technical design guide



CI/SfB | | (4-) Nf9 | |
MARCH 2019



PROFILED SHEETING

Eternit, the country's largest manufacturer of fibre cement products, has been producing profiled sheeting for over 100 years.

Eternit profiled sheeting is manufactured from a carefully formulated mix of Portland cement and water, reinforced with a combination of both natural and synthetic fibres.

The longevity of this formulation means that profiled sheeting has a life expectancy of at least 50 years.

P6 | P3 PROFILED SHEETING



Eternit has been backing British farming for more than 100 years with the only fibre cement profiled sheeting made in Britain.

Gorthleck, private residence using Profile 6

Contents

Range overview	4
Applications and sectors	6
Sustainability and the environment	18
Design considerations	24
Product range	36
Profile 6 detailing	50
Health, safety and sitework	72
Services and support	76



RANGE OVERVIEW

The Eternit range of Profiled Sheeting products is manufactured under quality management systems, which meet the requirements of ISO 9001 and environmental systems which comply with the internationally recognised ISO 14001 standard.

Adoption of the BES 6001 framework standard for the Responsible Sourcing of Construction Products by Eternit enables us to take a more responsible and sustainable approach to the sourcing of the materials that go into the manufacture of our products.

Top ten advantages of profiled sheeting

- 01** Can achieve A+ or A ratings in Green Guide
- 02** Only UK manufacturer of fibre cement
- 03** Highly cost effective weatherproofing
- 04** Low maintenance
- 05** No rust, rot or corrosion
- 06** Resistant to chemical attack
- 07** Vapour permeability reduces condensation
- 08** Excellent noise and thermal insulation
- 09** Quick and easy to install and fix
- 10** Wide product and colour range

Profile 6

A high strength fibre cement sheet reinforcement providing maximum impact strength and durability. Profile 6 has a very broad appeal for roofs of 5° pitch and over or vertical profiled sheeting.

More

pages 38-39

samples eternit.co.uk

web eternit.co.uk



Profile 3

Suitable for small structures in the agricultural, industrial and domestic sectors, such as garages, general purpose sheds and smaller buildings, and is easy to handle.

More

pages 42-43

samples eternit.co.uk

web eternit.co.uk



Farmscape Anthracite

As Profile 6 but designed to reduce the visual impact of buildings on the landscape by applying a subtle surface pigmentation to the top face of the sheet.

More

pages 40-41

samples eternit.co.uk

web eternit.co.uk

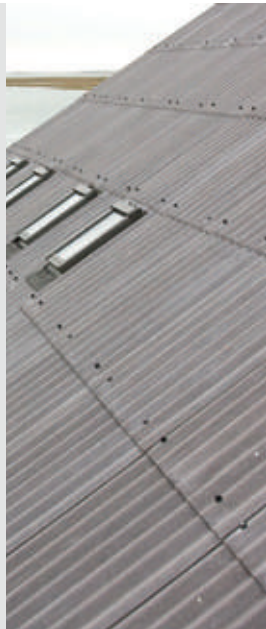

Translucent sheets

A wide range of GRP translucent sheets that meet the requirements of ACR[M]001, and have a fire rating of SAB Class 3.

More

pages 58-59

samples eternit.co.uk

web eternit.co.uk

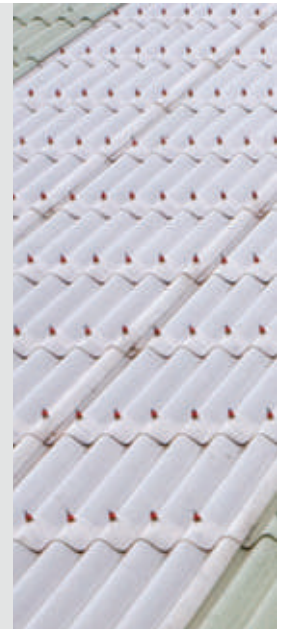

Accessories

An extensive range of integrated fibre cement fittings and fixings all supplied from one source

More

pages 46-47

samples eternit.co.uk

web eternit.co.uk

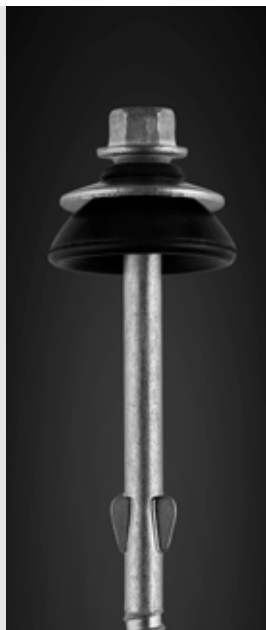

Ventilation

A wide and versatile range of ventilation systems for commercial agricultural and industrial applications.

More

pages 67-71

samples eternit.co.uk

web eternit.co.uk







APPLICATIONS AND SECTORS

Agricultural [dairy, beef, sheep, pigs, poultry, machinery and storage]	8
Equestrian	10
Industrial & Storage	12
Waste Management & Environmental	13
Leisure	14
Commercial	15
Health & Education	16
Residential	17



Dairy and beef: Ashford Grange Farm, using Profile 6 with spaced roof ventilation system

AGRICULTURAL

Profiled sheeting minimises reverberation for livestock buildings (reducing animal distress) and has a good resistance to aggressive atmospheric conditions, whether it be in agricultural, coastal or marine environments.

Sheep: Hereford Livestock market, using Profile 6



Pigs: Anthony Robinson, using Profile 6





Dairy and beef: Knocknegel, using Profile 6



Arable: Warden Farms using Profile 6



Poultry: Poultry shed using Profile 6

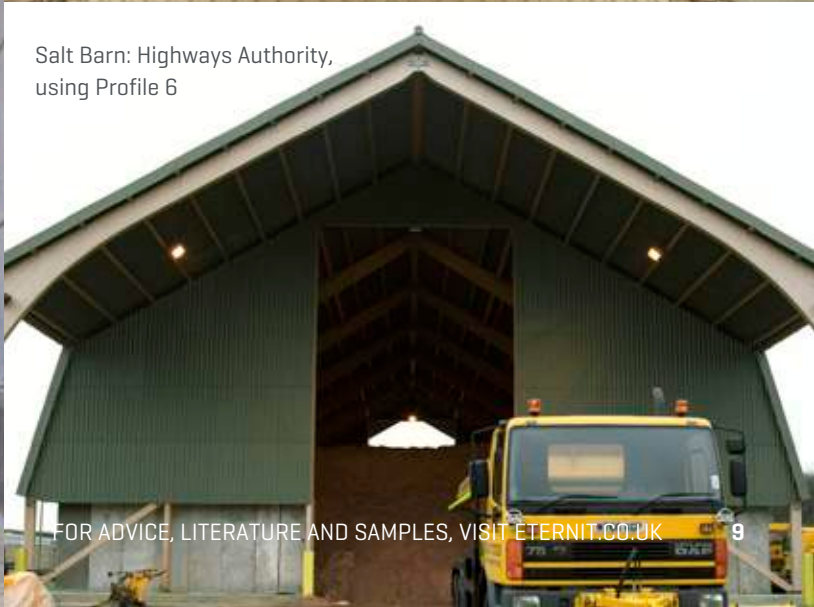

Salt Barn: Highways Authority, using Profile 6



Lavington Stud Farm, using Profile 3

EQUESTRIAN

P6 and P3 are exceptional for stable applications. Eternit's unique semi-compressed sheets help reduce humidity and condensation and are lighter to install. E-Luminate™ painted sheets optimise natural light, offering premium value to any installation.



Royal Cornish Showground,
using Profile 6

Peter Bull, Marston using Profile 6



 E-luminate paint coating in small stable





Imerys Tubes, using Profile 6



Hanson brick manufacturing plant, using Profile 6

INDUSTRIAL & STORAGE

Fibre cement has high resistance to aggressive environments and excellent performance characteristics ideal for industrial applications.



Nitric Acid Plant, using Profile 6



Imerys Tubes, using Profile 6

WASTE MANAGEMENT & ENVIRONMENTAL

Fibre cement has no metallic content and is minimally affected by frost and climatic temperature changes, ideal for the waste management and environmental sector.

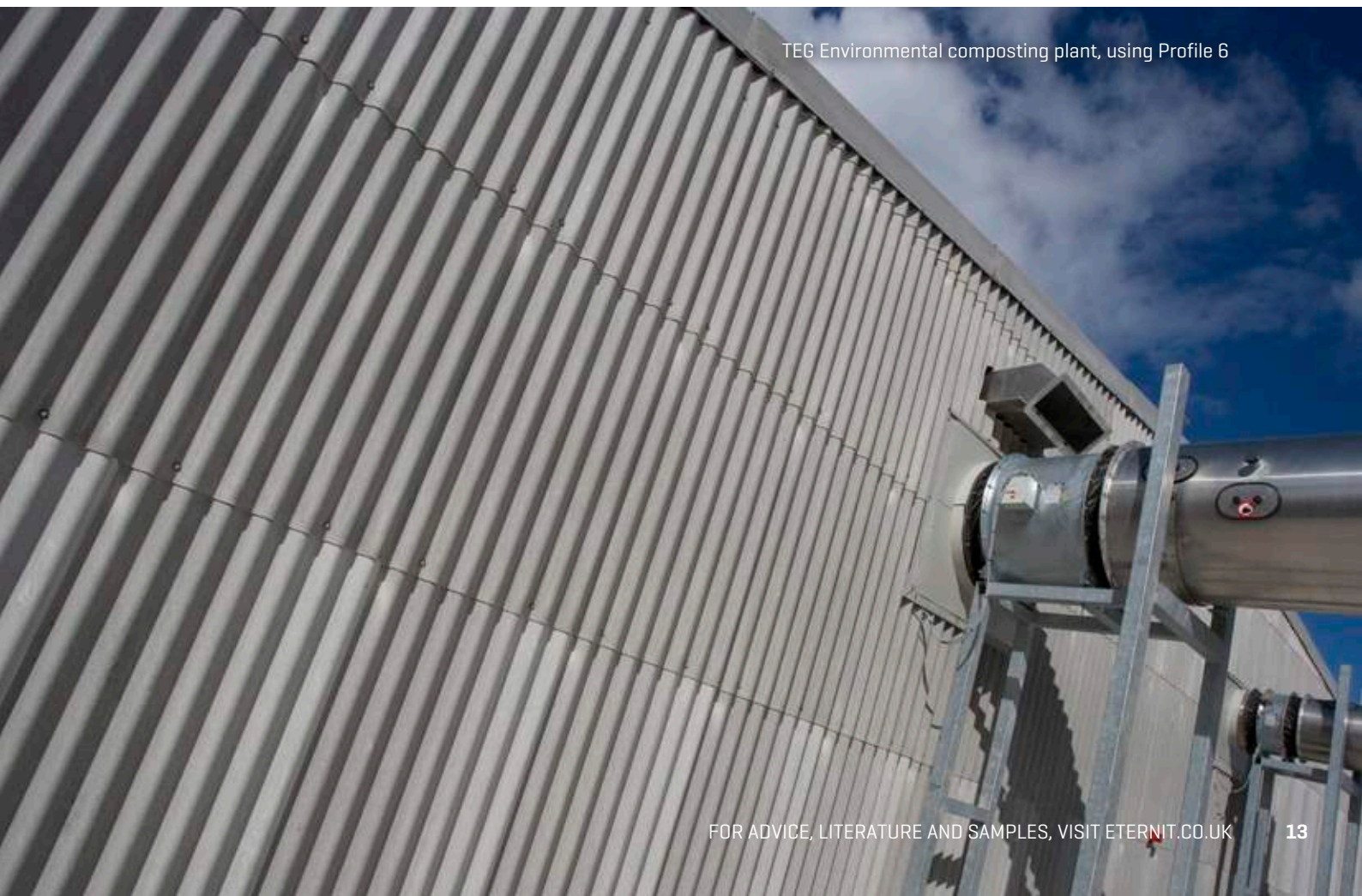

TEG Environmental composting plant, using Profile 6



Loch Awe Hostel, using Profile 6

LEISURE

As with the health and education sectors, excellent performance combined with an extensive colour range offers distinctive solutions for a wide range of environments.



Talgarth Mill Café, using Profile 6



Bowling Alley, using Profile 6



Good Luck Hope using Profile 6

COMMERCIAL

From distribution centres to business parks, profiled sheeting can be used to create unique building skins with visual impact and maximum durability.



Woodlands Trust head office, using Profile 6

Leybourne Chase using Profile 6



HEALTH AND EDUCATION

The wide ranging performance and aesthetic requirements of healthcare and educational buildings are easily met by profiled sheeting to create durable low maintenance solutions.

Kintore Way Children's Centre, using Profile 6





Gorthleck, private residence using Profile 6

RESIDENTIAL

Profiled sheeting combines well with other modern building materials to give unique visual character to walls or roofs for many residential applications.



School, using Profile 6



Daisy bank Cottage, B&B, designed by PAD Studio, using Profile 6





SUSTAINABILITY & THE ENVIRONMENT

Adopting best practice	20
Manufacture and carbon reduction	22
Assessing the sustainability of fibre cement profiled sheeting	23

ADOPTING BEST PRACTICE

“Sustainability is that which meets the needs of the present without compromising the ability of future generations to meet their own needs...”

The United Nations World Commission on the Environment and Development

The issues of global warming, climate change and their effect on our environment are becoming ever more important throughout the construction industry.

At Eternit we are at the forefront of helping our customers and suppliers to put environmental best practice at the top of their agenda.

BES 6001: Responsible sourcing

Eternit is committed to sourcing its raw materials and managing its supply chain in a responsible and sustainable manner and has been accredited BES 6001 'Framework Standard for the Responsible Sourcing of Construction Products'. This accreditation means:

- We are responsible for our supply chain, both who we choose and their actions.
- We are responsible for raw materials we purchase.
- We are responsible for the services we procure.
- We can help architects, designers, developers and builders achieve a high level of points when building sustainably, using either BREEAM, The Code for Sustainable Homes or Eco Homes schemes. A 'good' BES 6001 rating can be worth 2 points in the 'materials' category.

Best practice

Our commitment to best practice in the sustainability of our products, responsible sourcing of the materials used in our products, and the environmental impact of our operations is conducted in the following key areas:

- Health & Safety
- Environment
- Quality
- Corporate Social Responsibility

Eternit operates certified Quality, Health and Safety and Environmental management systems, to the internationally recognised ISO 9001, ISO 14001 and OHSAS 18001 standards.

In order to maintain its certification to ISO 14001, Eternit has to minimise the harmful effects on the environment caused by its activities and also to achieve continual improvement with its environmental performance.

The quality of Eternit's products and services remains at the top of the agenda in the overall company business strategy, and the maintenance of a quality management system operating to ISO 9001 ensures that the manufacturing, sales and distribution processes are continually monitored and improved to meet the changing needs of our customers.

Eternit maintains a Health and Safety management system operating to OHS 18001 covering all aspects of the business, including manufacturing, materials handling, administration, engineering, external sales and interaction with customers or contractors either at our sites or on their premises.

Gorthleck, private residence using Profile 6



MANUFACTURE & CARBON REDUCTION

Our factory

Our manufacturing factory in the UK is ISO 9001, 14001 and ISO OHSAS 18001 accredited. This means they operate under internationally recognised standards and controls, providing the best in quality and sustainability for the people working in them and the products coming out of them.

Manufacture of fibre cement

This is a low energy process using readily available locally sourced or sustainable resources which are natural and abundant. Production waste is recycled into the production process.

Cement can often be a main contributor to the equivalent carbon dioxide emission during the manufacture of fibre cement products, so we continually develop formulations that replace cement by raw materials of low carbon equivalent.

As the only UK manufacturer of profiled sheeting, we can guarantee fewer delivery-miles for these products compared to imported products.

Water recycling

We're saving water each year through recycling water recovered from manufacturing processes. We have various schemes in place where we re-use waste material within our products as well as re-usable material from other manufacturers.

Energy usage monitoring and saving

Many organisations simply rely on information from a single meter to gauge energy consumption.

We've introduced sub-meters and mobile metering that enable us to identify precisely how much energy is used by different facilities on our sites. This means that energy usage can be managed in a much more sophisticated and informed way.

Electricity, gas, oil and water consumption is measured and compared across our factories. The monthly data helps us to identify where improvements can be made. At one site we periodically use methane produced by a local landfill to generate the heat which cures tiles and heats the workplace.

Reducing our carbon footprint

Eternit is developing its sustainable Carbon Management Programme aimed at reducing carbon emissions and improving its 'carbon footprint'.

The monitoring of Eternit's carbon reduction target is overseen by an internal Energy Action Group, which uses a sophisticated computer based energy management system which monitors energy usage and CO₂ generated, against tonnage of material produced.

Lower embodied energy products

A product manufactured using a process which uses less energy and less primary raw materials will generally have a much lower embodied energy (the energy used to acquire, process, and manufacture the product, including any transportation related to these activities). These products will be more sustainable and will help specifiers to attain higher ratings against sustainability requirements set out in current legislation.

When used in A+ rated constructions, fibre cement profiled sheeting can achieve 3 credits in the materials category of the Code for Sustainable Homes and can help achieve 'Good' or 'Excellent' ratings for BREEAM for non-residential buildings.



ASSESSING THE SUSTAINABILITY OF FIBRE CEMENT PROFILED SHEETING

BRE Green Guide on-line

Our range of fibre cement profiled sheeting is UK manufactured and as such, is the only fibre cement profiled sheeting able to achieve A+ or A ratings in the BRE Green Guide to Specification.

The BRE 'Green Guide' online www.thegreenguide.org.uk contains a listing of building materials and components which are assessed in terms of their environmental impact across their entire life cycle – from 'cradle to grave', within comparable specifications.

The Green Guide contains more than 1200 specifications used in various types of building which examine the relative environmental impacts of the construction materials commonly used in six different generic types of building covering six sectors.

Materials and components are arranged on a 'building element' basis so that designers and specifiers can compare and select comparable systems or materials that may be used in, say, roofs, walls, floors etc.

Across these building element categories, the Green Guide provides an extensive, but not complete, catalogue of building specifications covering most common building materials.

This data is set out as an A+ to E ranking system, where A+ represents the best environmental performance/least environmental impact and E the worst environmental performance/most environmental impact. BRE has provided a summary environmental rating – 'The Green Guide' rating – which is a measure of overall environmental impacts covering the construction specifications [i.e. they are not manufacturer specific].

Ratings tables

For each element, the Green Guide ratings are displayed alphabetically in tables. Depending on the number of specifications, the element group may have been divided into sub-categories. The ratings are based on the range for the whole element group, not the sub-categories.

The table below contains information taken from 'The Green Guide' and details some of the specifications covered in the rainscreen profiled sheeting section.

When used in one of the construction types[†] listed in the table below, fibre cement profiled sheeting achieves an A+ rating.

Description	Summary rating	
	domestic, retail health	commercial industrial, education
Low pitched roof: Galvanised steel rafters and joists, double skin built up profiled roof cladding (coated steel inner, insulation and profiled air cured fibre cement sheeting outer skin) element no. 1012550002	A	A ⁺
8.1d Insulated cladding on steel frame with no internal finish (industrial shed): Fibre cement (air cured) profiled sheet built up cladding with insulation and coated steel liner on steel support, structural steel frame, with no internal finish element no. 1006600001	A	A

[†] The constructions shown right are recent additions to the 'Green Guide to Specification'. There are many other constructions covered at www.thegreenguide.org.uk





DESIGN CONSIDERATIONS

Recommended design procedure	26
Legislation, guidance and reference	28
Windloadings and lap treatment	30
Setting out the roof	32
Mitring	34
Fixing	35



RECOMMENDED DESIGN PROCEDURE

Designers are advised to consider the following steps when commencing a design incorporating Eternit profiled sheeting.

This information is provided for guidance only and designers should ensure that they make all the necessary calculations and take into account all aspects of the specific project design and location.

In addition to this Profiled Sheeting manual, reference should also be made to the following standards:

- BS 8219: Installation of Sheet Roof and Wall Coverings – Profiled Fibre Cement – Code of Practice.
- BS 5427: Code of Practice for the Use of Profiled Sheet for Roof and Wall Cladding on Buildings.
- BS 5502: Buildings and Structures for Agriculture, Parts 20, 21 and 22.

Step 1: Legislation and planning

Guidance on legislation is given on pages 28-29. Planning permission may be necessary and is dependent on Local Authority policy and control.

Step 2: Wind and snow loadings

Calculate the wind suction loading in accordance with BS EN 1991 Eurocode 1 - Actions on structures – Part 1-4: General Actions - Wind Actions.

Calculate the snow loadings in accordance with BS EN 1991 Eurocode 1 - Actions on structures – Part 1-3: General Actions - Snow Loads.

Step 3: Exposure, wind and rain

Establish the exposure zone of the site by reference to the map on page 30. This divides the UK into 2 categories of exposure to driving rain and is based on the table in BS 8219: 2001 + A1: 2013.

Step 4: Assess performance against regulatory requirements

Profiled sheeting performance criteria will vary according to design, building function etc., Further guidance is shown on the following pages: 'Sound insulation', page 48, 'Fire', page 48, 'Condensation control', page 49, and 'Thermal', page 49.

Step 5: Profiled sheeting selection

The choice of profiled sheeting is a combination of planning, aesthetic and performance criteria. The key factors are shape, size, colour, texture, material and sustainability, see pages 38-49.



Step 6: Framework and support rail

Determine design of profiled sheeting and configuration of support rails with structural engineer and framework manufacturer.

Ensure that the structure is adequate for the total weight of the profiled sheeting as installed and for the calculated wind loading and any other relevant loading criteria. Weights of panels are shown on the appropriate product pages.

Step 7: Fixing method

Select the fasteners to suit the profiled sheet and type of purlin being used.

Step 8: Fittings and accessories

Select the accessories to suit the particular details of the building by referring to Design Detailing pages 50-71.

Step 9: Produce project specific specifications and drawings

LEGISLATION, GUIDANCE AND REFERENCE

Before contemplating any profiled sheeting project, the designer and contractor must be aware of the current legislation, the design requirements and standards that govern and influence the style, parameters, performance, products and construction of the project. The following section summarises many of the relevant documents, but is by no means exhaustive.

Structure

- England and Wales: Part A 'Structure'
- Scotland: Technical Handbook, Section 1 'Structure'
- Northern Ireland: Part D 'Structure'



Fire

- England and Wales: Part B 'Fire safety'
- Scotland: Technical Handbook, Section 2 'Fire'
- Northern Ireland: Part E 'Fire safety'



Moisture

- England and Wales: Part C 'Site Preparation and Resistance to Moisture'
- Scotland: Technical Handbook, Section 3 'Environment'
- Northern Ireland: Part C 'Site Preparation and Resistance to Moisture'



Sound

- England and Wales: Part E 'Resistance to the Passage of Sound'
- Scotland: Technical Handbook, Section 5 'Noise'
- Northern Ireland: Part G 'Sound Insulation of Dwellings'



Ventilation

- England and Wales: Part F 'Ventilation'
- Scotland: Technical Handbook, Section 3 'Environment'
- Northern Ireland: Part K 'Ventilation'



Thermal

- England and Wales: Part L 'Conservation of Fuel and Power'
- Scotland: Technical Handbook, Section 6 'Energy'
- Northern Ireland: Part F 'Conservation of Fuel and Power'



Scottish Technical Handbooks

The sections referred to on page 28 are contained in the two Scottish technical handbooks, one covering domestic construction, the other non-domestic.

Other guidance

- ACR[M]001: Test for Non-Fragility of Large Element Roofing Assemblies
- ACR[CP]001: Recommended Practice for Work on Profile Sheeted Roofs
- Health and Safety Executive HSG33: Health and Safety in Roof Work

Building Regulations

These are mandatory regulations and, in England and Wales, are generated and approved by the Department for Housing, Communities and Local Government.

In Scotland they are generated and approved by the Scottish Government and in Northern Ireland, by The Department of Finance.

They must be complied with for all new-build and a great deal of refurbishment work. They consist of the Building Regulations 2010 [as amended] for England and Wales, the Building [Scotland] Regulations 2004, and the Building [Amendment] Regulations [Northern Ireland] 2016.

Compliance with these regulations is the responsibility of the building designer, who may be the owner of the building, his appointed architect, a structural engineer appointed by the owner or his architect or, in the case of small buildings, the actual builder.

The increasing complexity of construction and the codes that govern design has led many building designers to request the specialist services of a profiled sheeting or building envelope designer.

The Approved Documents of the Building Regulations [England and Wales], the Technical Handbooks [domestic and non-domestic] [Scotland] and the Technical booklets [Northern Ireland] provide practical guidance for some of the common building situations in respect of the requirements for materials and workmanship.

Copies of the Approved Documents that accompany the Building Regulations for England and Wales can be downloaded from the Department for Housing, Communities and Local Government web site or obtained from RIBA Bookshops.

Copies of the complete set of Handbooks that accompany the Building [Scotland] Regulations 2004 for Scotland can be downloaded from the Scottish Government website.

British Standards

A British Standard is a published document that contains a technical specification or other precise criteria designed to be used consistently as a rule, guideline, or definition. They are a summary of best practice and are created by bringing together the experience and expertise of all interested parties – the producers, sellers, buyers, users and regulators of a particular material, product, process or service.

Standards are designed for voluntary use and do not impose any regulations. However, laws and regulations may refer to certain standards and make compliance with them compulsory.

The principle British Standards relevant to this document are:

- BS EN 494: Fibre Cement Profiled Sheets and Fittings – Product Specification and Test Methods
- BS 5427: Code of Practice for The Use of Profiled Sheet for Roof and Wall Cladding on Buildings
- BS 8219: Installation of Sheet Roof and Wall Coverings – Profiled Fibre Cement – Code of Practice
- BS 5502: Part 20: Buildings and Structures for Agriculture Code of Practice for General Design Considerations
- BS 5502: Part 21: Buildings and Structures for Agriculture Part 21. Code of Practice for Selection and Use of Construction Materials
- BS 5502: Part 22: Buildings and Structures for Agriculture Code of Practice for Design, Construction and Loading
- BS 5502: Part 23: Buildings and Structures for Agriculture Code of Practice for Fire Precautions
- BS EN 1991 Eurocode 1: Actions on Structures:
 - Part 1-1: General Actions – Densities, Self Weight, Imposed Loads for Buildings
 - Part 1-3: General Actions – Snow Loads
 - Part 1-4: General Actions – Wind Actions
- UK National Annex to BS EN 1991-1-3
- UK National Annex to BS EN 1991-1-4
- BS 476: Fire Tests on Building Materials and Structures:
 - Part 3: External Fire Exposure Roof Tests
 - Part 6: Method of Test for Fire Propagation of Products
 - Part 7: Surface Spread of Flame Test for Materials
- BS EN 13501-1: Fire Classification of Construction Products and Building Elements: Part 1: Classification Using Test Data from Reaction to Fire Tests
- BS 8200: Code of Practice for Non-Loadbearing External Vertical Enclosures of Buildings
- BS 6100: Glossary of Building and Civil Engineering Terms

Health and safety

To ensure safe working practices during construction, the designer should consider relevant safety regulations. These include the Construction [Design and Management] Regulations and the Health and Safety Executive's approved code of practice for management of health and safety at work.

Certain advisory bodies such as the National House Building Council (NHBC), Loss Prevention Council (LPC), Building Research Establishment Ltd (BRE), Advisory Committee for Roofsafety (ACR) and Timber Research and Development Association (TRADA) also produce recommendations and guidance on construction which should be considered.

WIND LOADINGS & LAP TREATMENT

Introduction

When specifying profiled sheeting, the windloading and exposure of the site is critical to ensuring the optimal sealing and fixing of the sheets.

As the sheets are fixed through oversize holes in the crest corrugations, they cannot be used in a stressed skin construction, and cannot be assumed to provide lateral restraint to the top flange of a purlin.

When designing the steel structure the maximum purlin deflection under total serviceability loads should not exceed the formula: $\text{purlin span}/220$.

Exposure

Determine the expected degree of exposure by examining the map.

Where buildings stand above their surroundings, or are situated in open country with no windbreaks within about 1km (including sites on or near the sea coast or hilltop sites which are above the general level of trees, etc.), they must be considered subject to severe exposure. Refer to BRE Digest 127 'An Index to Exposure to Driving Rain', or the BSI Draft for Development DD93, taking account of the recommendations regarding localised effects, on high buildings, on buildings of any height, on hill slopes or hill tops, in coastal districts, or in other areas where higher exposure gradings are likely.

Wind loading should be calculated in accordance with BS EN 1991 Eurocode 1: Actions on Structures – Part 1-4: General Actions – Wind Actions.

Centres of support

For Profile 6: Purlins at 1375mm c/c for wind suction of 1.89kN/m^2 . Rails at 1825mm c/c for loadings up to 1.40kN/m^2 .

For Profile 3: Purlins at 925mm c/c for loadings up to 1.79kN/m^2 (multiple span) or 1.49kN/m^2 (single span). Rails at 1225mm centres for loadings up to 1.02kN/m^2 (multiple span) or 0.64kN/m^2 (single span).

Highlands and Islands specification

For users in the North and West of Scotland and the Isles (indicated by shading ) , for wind loads up to 2.5kN/m^2 , we recommend the following:

Profile 6 can be fixed to purlins at 1040mm maximum centres using standard fasteners and sealing washers.

Profile 6 can be fixed to purlins at 1375mm centres providing curved diamond washers, together with diamond felt washers are used under the head of the fasteners to increase the bearing area and therefore prevent the sheets lifting over the fasteners. The diamond washers are used in addition to the standard sealing washers.



Exposure Zones

Approximate volume of wind-driven rain (litres/m²) per spell:



Note: Taken from BS 8219

Curved diamond washers are typically 38 x 38mm and are used with a diamond felt washer underneath to provide a seal to the sheet. Please note that commercially available diamond washers are not generally curved to the correct radius to suit the Profile 6 corrugation.

Profile 3 should be fixed to purlins at 700mm maximum centres using standard fasteners and sealing washers.

Lap and seal

Establish the requirement for lapping and sealing by reference to the map of the UK left and the tables below.

Sheltered to moderate sites

Less than 56.5 l/m² of wind-driven rain per spell.

Minimum Roof pitch	Minimum End lap	End laps treatment	Side laps treatment
≥22.5°	150mm	Unsealed	Unsealed
≥15°	300mm	Unsealed	Unsealed
≥15°	150mm	Sealed	Unsealed
≥10°	150mm	Sealed	Sealed
≥5° *	300mm	Double sealed	Sealed

* Maximum roof slope length of 15m for roof pitch less than 10° (Profile 6 only).

Moderate to severe sites

More than 56.5 l/m² of wind-driven rain per spell.

Minimum Roof pitch	Minimum End lap	End laps treatment	Side laps treatment
≥25°	150mm	Unsealed	Unsealed
≥15°	150mm	Sealed	Unsealed
≥15°	150mm	Sealed	Sealed
≥10°	300mm	Sealed	Sealed
≥5° *	300mm	Double sealed	Sealed

* Maximum roof slope length of 15m for roof pitch less than 10° (Profile 6 only).

Lap treatments

Lap – This describes how much one sheet overlaps another at each end (end lap) and each side (side lap).

Pitch – This describes the degree to which the roof slopes.

The table above is based upon BS 8219 and applies to roof slopes not exceeding 32m.

[Consult the Eternit Technical department for advice on roof slopes that exceed 32m.]

Minimum roof pitches

The minimum pitch for Profile 6 sheets is 5° and 10° for Profile 3.

Where slopes are between 5° and 10°, the maximum slope length should be 15m, with double sealed end laps and single sealed side laps.

On roofs over 10° pitch, where parapets might allow snow build-up, 300mm double sealed end laps and single sealed side laps are recommended. On such roofs, workmanship as regards positioning and placing of butyl strips is more critical and greater care is necessary with lap sealing.

Fittings

The requirement for sealing laps also applies to any fibre cement fittings that are used together with the sheets.

Sealing

Sealants*

It is important to select a good quality sealant. Inferior sealants can lead to cracking, chalking and failure in use. For best results, BS 8219 recommends a pre-formed 8mm diameter mastic ribbon of butyl or a polyisobutylene-based material, which has a rubbery, tacky consistency, and which will adhere to both surfaces when sheets are overlapped.

Side laps

When sealed side laps are required, butyl strips should be positioned as shown in Fig.1 below.

End laps

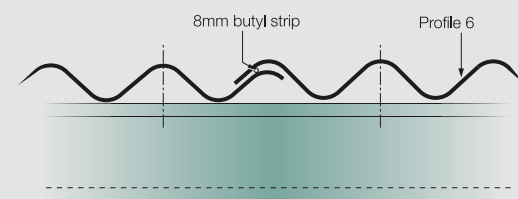

Fig.1a Profile 6 side lap

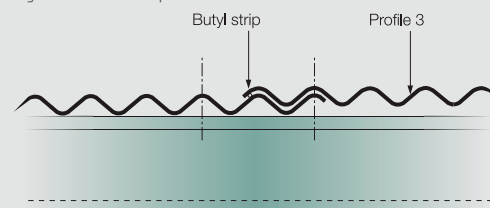

Fig.1b Profile 3 side lap

The minimum end lap for Profiles 6 and 3 is 150mm, fixed as shown in Fig.2 below.

Where double sealing is necessary, with a 300mm end lap,

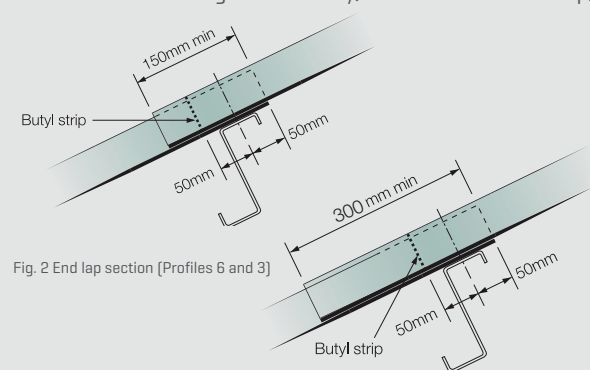

Fig. 2 End lap section (Profiles 6 and 3)

the second butyl strip should be positioned 100 to 200mm below the fixing, as shown in Fig.3 below.

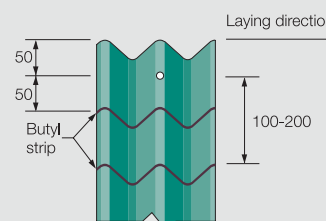

Fig. 3 End lap (plan)

SETTING OUT THE ROOF

Laying the sheets

Roof sheeting should commence from one end of the building at eaves level, rising in vertical tiers, one sheet wide, from eaves to ridge. Where cranked crown sheets are used, it is especially important that the slopes are accurately aligned with each other. Vertical sheeting should also be fixed in tiers, one sheet wide, from the lowest level of the profiled sheeting.

The end laps of each row of sheets should form a continuous straight line from gable to gable and must not be staggered. Similarly, the side laps should be aligned from eaves to ridge.

Checking the structure

Before sheeting is commenced, the structure should be checked to ensure that all purlins and rails are in a true plane, correctly spaced and securely fixed and adequately restrained.

Setting out plan

Typical double slope roof is shown below with two piece adjustable close fitting ridge and Profile 6 sheets.

Note: For typical mitring detail with 150mm end lap, see following page.

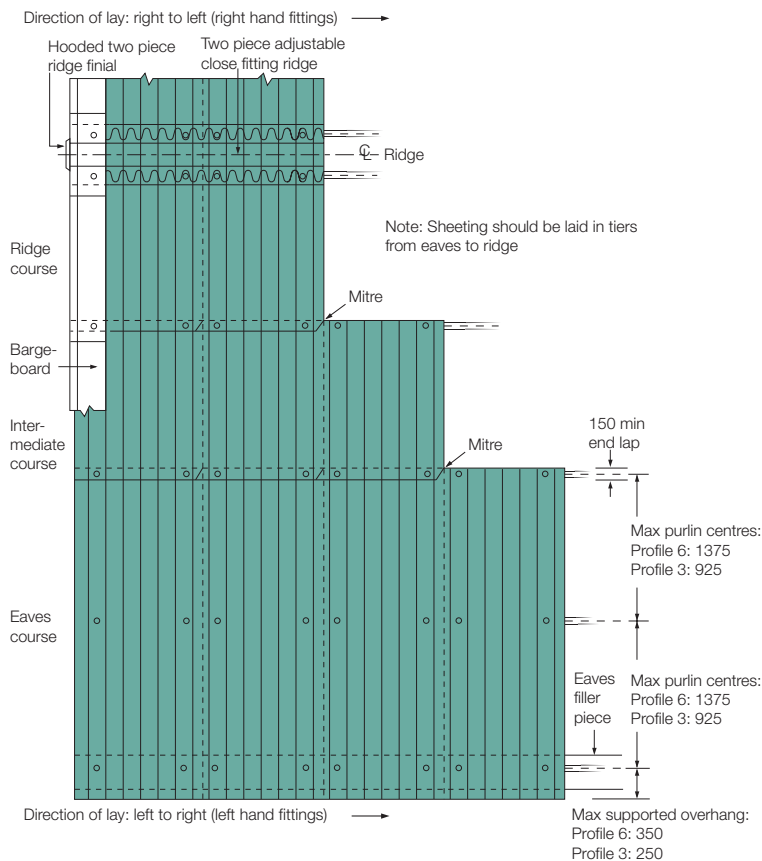
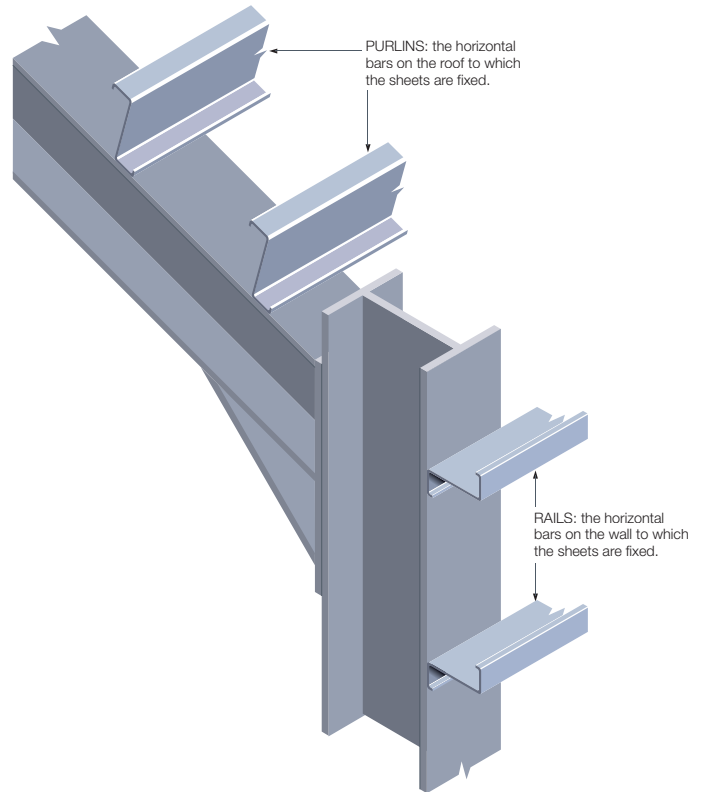



MITRING

General guidance

To avoid four thicknesses of sheeting at the junctions of side and end laps, it is necessary for two of the sheets at each junction to be mitred at the corners so that they lie in the same plane.

Mitres on Profile 6 and 3 sheets should be cut from a point 150mm up the vertical edge from the corner [or the amount of the end lap] to a point 70mm [131.2mm for Profile 3] along the horizontal edge, i.e., the width of the side lap by the length of the end lap.

Ideally, the gap between mitres should be a minimum of 3mm to a maximum of 6mm. Box mitres should be avoided. The mitred joint is covered top and bottom by the other two sheets, and is thus weatherproof and unseen [see typical mitring details below.]

Note: Mitres must not be cut in situ.

Mitring layouts

The procedure for mitring the sheets for single and double slope roofs is indicated on the mitre plans below [Figs.1-3].

On double slope roofs with two piece adjustable close fitting ridges or cranked crown ridges, one slope must be laid left to right and the other right to left.

When cranked crown ridge pieces are used, both top courses of roofing sheets and the cranked crowns should be mitred.

When using two piece ridges, the top courses of sheets and the ridges should not be mitred.

Note: All mass-produced building products are allowed certain dimensional tolerances. This applies to both profiled fibre cement sheets and steelwork. Because of these permitted variations in dimensions, regular checks should be carried out on measurements at mitres, and adjustments made as and when necessary.

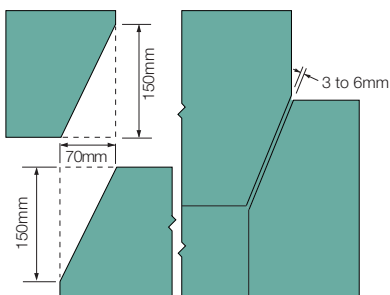

Fig.1a Mitring detail - Profile 6

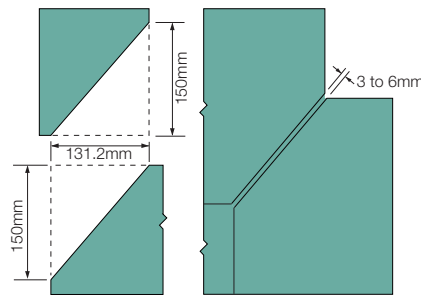

Fig.1b Mitring detail - Profile 3

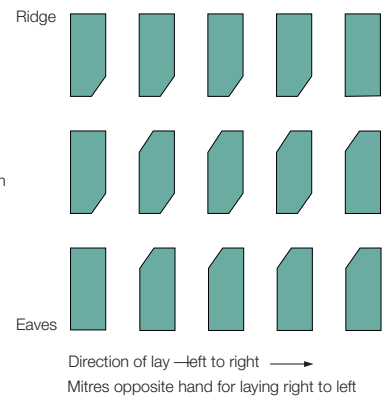

Fig. 2 Mitring plan - single slope roof

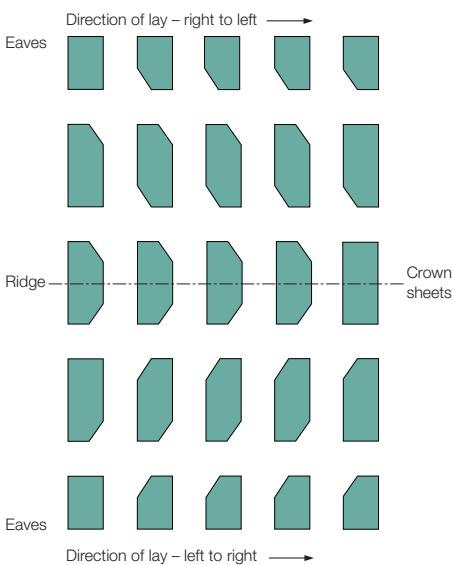

Fig. 3 Mitring plan - double slope roof

FIXING

General guidance

All sheets must be fixed in accordance with the recommendations of BS 8219.

Profiled sheeting should always be fixed with 2 fasteners per sheet per purlin.

The selection of the correct sheet fastener is extremely important. The integrity of the roof covering, type of purlin or rail system, and weatherproofing with washers and caps all must be considered to avoid premature failure, corrosion or a leaking roof.

Topfix fasteners

Self-drilling, self-tapping 'topfix' fasteners are generally used to fix Profile 6 sheets to the purlins [Fig. 4]. These fasteners drill through the Profile 6 sheet, creating a 2mm oversize hole and self tap into the purlin. It is important that the fasteners are installed using the correct power tools, which should have an adjustable depth setting device to ensure the washers are seated correctly. The fasteners typically have different drill points to suit the different purlin types:

When following the recommendations of the fastener manufacturers, please give particular regard to minimum purlin thickness and maximum roof pitch.

Traditional fasteners

In certain circumstances it may be preferable to use traditional fasteners such as hook bolts, crook bolts and drive screws. There are, however, additional health and safety implications to consider when using these fixings.

The fasteners are generally 8mm diameter for Profile 6 and are fixed through 10mm diameter pre-drilled holes in the sheet. For hook and crook bolts, the fixing should be positioned 4mm upslope from the back leg of the purlin. Drive screws should be located centrally on the purlin.

Profile 3 sheets are generally fixed using 6mm diameter fasteners and an 8mm diameter hole should be drilled through the sheet.

Notes: When fixing to timber purlins, BS 5268: Structural use of Timber, recommends that the minimum edge distance of the fixing should be five times the fixing diameter to avoid undue splitting of the timber.

Fasteners should be installed perpendicular to the plane of the roof.

With some types of insulated cladding, or where sealant has been used, sheet settlement can take place. It may be necessary to retighten the fixings after a suitable period.

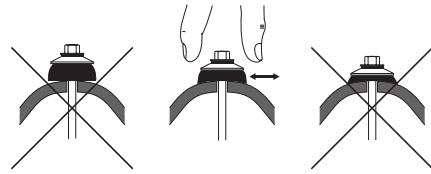

Fig. 4 Checking the topfix fasteners for tightness

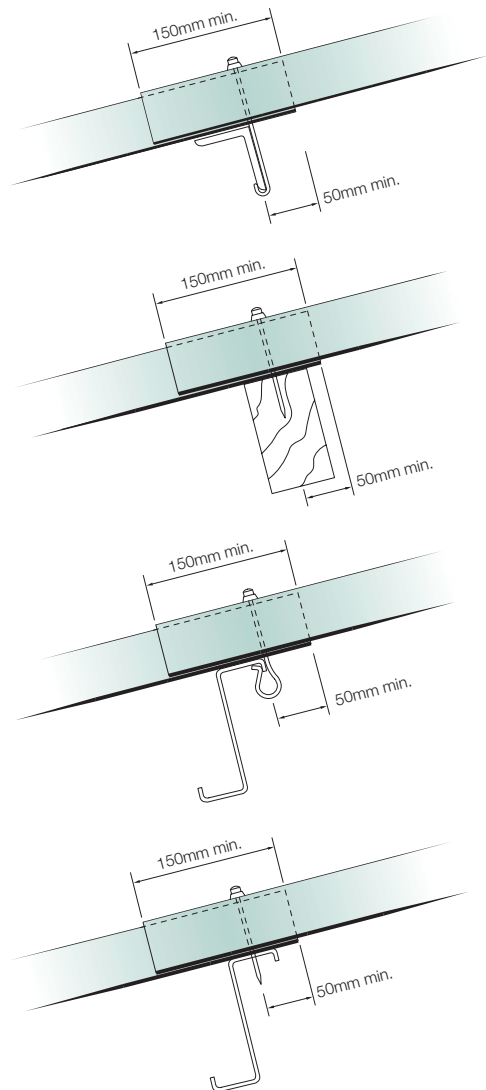

Fig. 5 Typical fixing details





PRODUCT RANGE

Profile 6	38
Farmscape Anthracite	40
Profile 3	42
E-Luminate	44
Colour range	45
Accessories	46
Description, properties and performance	48

PROFILE 6

Description

Profile 6 is a high strength fibre cement sheet with polypropylene reinforcement strips inserted at precisely engineered locations that run along the length of the sheet. This provides maximum impact strength without affecting the durability of the product.

The reinforcing strips within Profile 6 only become effective when the sheet is fully fixed.

Profile 6 has a very broad appeal. It is designed for roofs of 5° pitch and over and for vertical profiled sheeting in both single skin and insulated constructions.

A comprehensive range of accessories is available and apart from the natural grey finish, sheets and accessories can be supplied in a wide range of colours (see pages 45).



Dimensions

Standard lengths	1220, 1375, 1525, 1675, 1825, 1975, 2125, 2275, 2440, 2600, 2750, 2900, 3050mm
Farmscape Anthracite lengths	1525, 1675, 2440, 2750, 2900, 3050mm [see page 41]

Approximate covering capacities for estimating purposes:

- [1375mm purlin spacing, normal side lap, 150mm end lap] approx 1.13m² of material covers 1.0m²
- [1375mm purlin spacing, normal side lap, 300mm end lap] approx 1.19m² of material covers 1.0m²

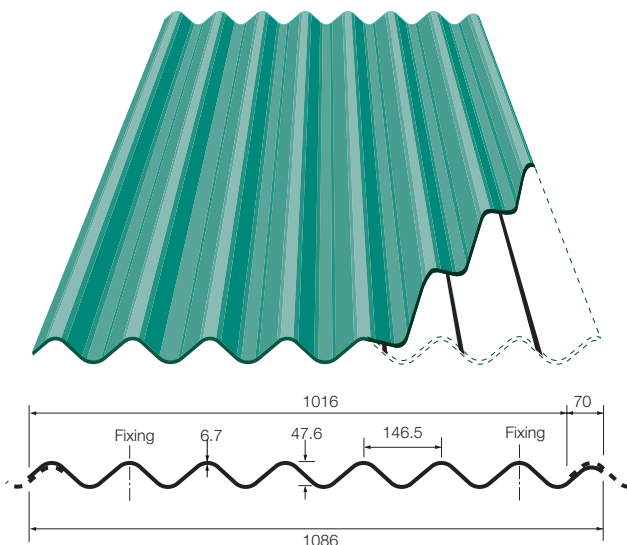

Technical data

Overall width	1086mm
Net covering width	1016mm
Thickness [nominal]	6.7mm
Minimum density	1400kg/m ³
Pitch of corrugation [nominal]	146.5mm
Depth of profile	47.6mm
Type of product	NT
Profile height category	C
Class	1X
Side lap	70mm
Minimum end lap	150mm
Maximum purlin centres	1375mm
Maximum rail centres	1825mm
Maximum unsupported overhang	350mm
Approx. weight of roofing as laid with 150mm end laps: single skin including fixings	17kg/m ²
Minimum roof pitch	5°

Measured crest to crest, the sheet has 6 full corrugations of 146.5mm and 1 corrugation of 136.8mm.

Manufactured in the UK, Eternit's fibre cement profiled sheeting can achieve up to an A+ (the lowest environmental impact) in the Green Guide to Specification.



Manufactured in the UK, Eternit's fibre cement profiled sheeting can achieve up to an A+ (the lowest environmental impact) in the Green Guide to Specification.



FARMSCAPE ANTHRACITE

Description

The Farmscape product range is designed to reduce the visual impact of buildings on the landscape by giving them a weathered look from new. This is done by applying a surface pigmentation to the top surface of the sheet during manufacture. Unlike a dense layer of gloss paint, this process allows the distinctive texture of the fibre cement substrate to show through and give the product a far more natural appearance than that traditionally available to planners and designers.



Dimensions

Standard lengths	1525, 1675, 2440, 2750,
[Farmscape Anthracite finish]	2900, 3050mm [see page 41]

Approximate covering capacities for estimating purposes:

- [1375mm purlin spacing, normal side lap, 150mm end lap] approx 1.13m² of material covers 1.0m²

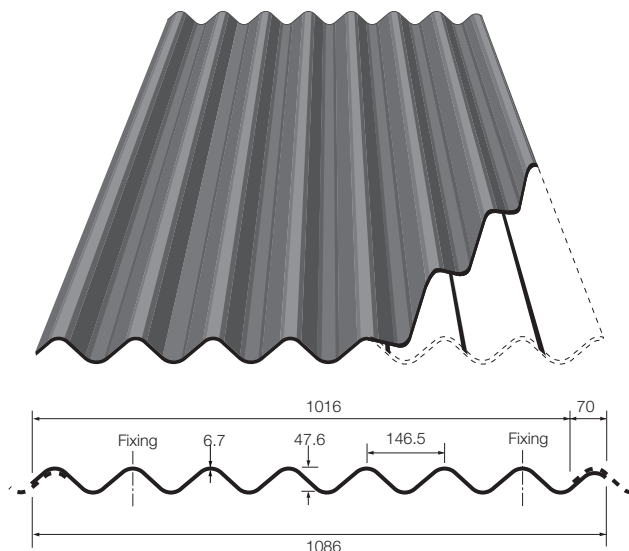

Features of Farmscape

- Economically priced product for buildings that have to blend into the landscape
- Factory-applied matt finish
- Vapour-permeability minimises condensation
- Non-fragile material suitable for HSG 33 applications
- Easy to install and fix

Technical data

As for Profile 6, see pages 38-39.

Fittings

A limited range of fittings is available for the Anthracite sheets but the full range of Profile 6 fittings is available in Natural Grey.

PROFILE 3

Description

Profile 3 is easy to handle and is suitable for small structures in the agricultural, industrial and domestic sectors, such as garages, general purpose sheds and smaller buildings.

A comprehensive range of accessories is available. The sheets and accessories can be supplied in a wide range of colours [see page 45].



Dimensions

Standard lengths	1525, 2450, 3050mm
------------------	--------------------

Approximate covering capacities for estimating purposes:

- [917mm purlin spacing, normal side lap, 150mm end lap] approx 1.27m² of material covers 1.0m²
- [917mm purlin spacing, normal side lap, 300mm end lap] approx 1.33m² of material covers 1.0m²

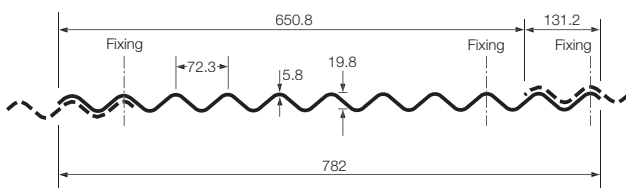
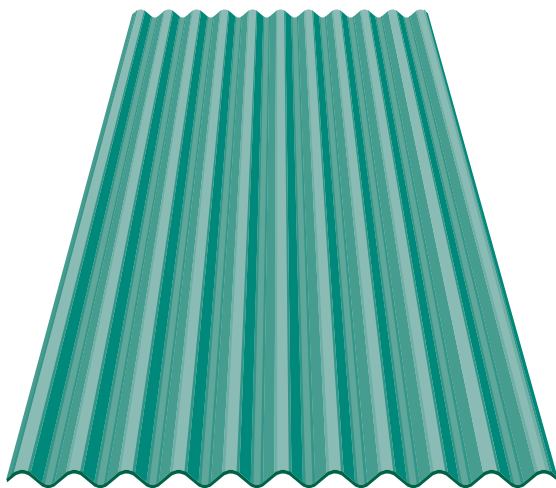

Technical data

Overall width	782mm
Net covering width	650.8mm
Thickness [nominal]	5.8mm
Minimum density	1400kg/m ³
Pitch of corrugation [nominal]	72.3mm
Depth of profile	19.8mm
Type of product	NT
Profile height category	A
Class	1X
Side lap	131.2mm
Minimum end lap	150mm
Maximum purlin centres	925mm
Maximum rail centres	1225mm
Maximum unsupported overhang	250mm
Approx. weight of roofing as laid with 150mm end laps: single skin including fixings	14.5kg/m ²
Minimum roof pitch	10°

Manufactured in the UK, Eternit's fibre cement profiled sheeting can achieve up to an A+ [the lowest environmental impact] in the Green Guide to Specification.



New E-Luminate™

Making a brighter future



Designed to maximise light

The more we can replicate the natural environment inside a livestock or stable building, the better it is for the animals.

At Eternit we have been investigating ways that we can help improve the living conditions for animals whilst retaining the performance of the building and not adding additional overheads like electricity and maintenance.

E-Luminate is a technical product solution which can be used with any P6/P3 painted sheet colour option.

Please call your Area Sales Manager for information.

Applications

- Roofs & Cladding
- Storage
- Garages & Sheds
- Stables

P6 | **P3**
PROFILED SHEETING

COLOUR RANGES

Request a sample

You can simply visit: eternit.co.uk

Painted colour range

Experience gained over many years has shown that the Eternit colour range will meet the wide ranging design requirements in both rural and urban areas. All the colours have been chosen for their ability to harmonise with the most commonly used building materials – brick, slate, stone, concrete and timber. Use colour codes [in brackets] when creating product codes.

Black [GQ 60]



Van Dyke Brown [BS 08 B 29]



Gunmetal Grey [BS 18 B25]

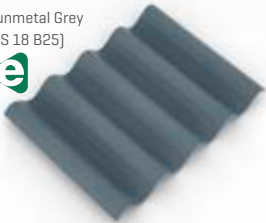

Brown [GQ 78]



Cloud Grey [GS 92]



Tawny Brown [GQ 80]



Slate Blue [BS 18 B 29]



Laurel Green [BS 12 B 29]



Architect's choice

Farmscape

Anthracite sheets have a pigmented surface layer. Together with subtle variations in tone inherent in any natural cementitious product, the appearance will blend with almost any landscape from the day the building is erected. Only available for Profile 6.

Anthracite [pigmented surface layer on Profile 6 only]



Matt colours

These colours are part of the standard colour range but have a matt finish.

Bracken [12]

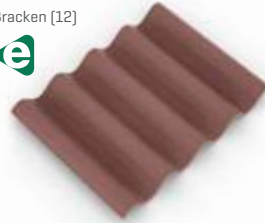

Sherwood [17]



E-Luminate™

Off-White is the colour used on the underside of E-Luminate products.

Off-White

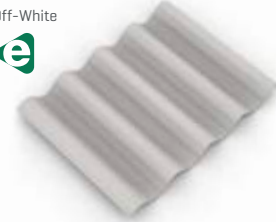

Natural Grey

Natural Grey is the standard unpainted finish for Profile 6 and Profile 3.

Natural Grey

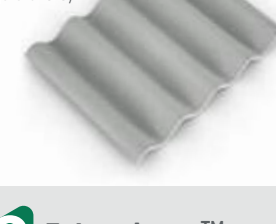

E-Luminate™

E-Luminate* products feature a special off-white paint coating to a painted sheet underside, researched and designed to increase light to internal livestock areas or agricultural buildings. Standard Profile 6 painted sheets are now available with E-Luminate [POA].

For further information please contact customer services.

*IMPORTANT: E-Luminate - the permeability of the surface exposed to the weather should not be any less than the permeability of the inner surface, otherwise the sheets could bow excessively as they absorb moisture from rain and possibly cracks could form. Although the specialist paint is vapour permeable, it does reduce the permeability of the products and so, when the underside of fibre cement sheets are painted, the top surface also has to be painted. Therefore E-Luminate is not suitable with non-painted sheets.

ACCESSORIES

A selection from our range of fittings is shown below. The full extent of our comprehensive range of fittings and accessories is set out in our 'Profiled Sheetting Parts List', which is available on request.

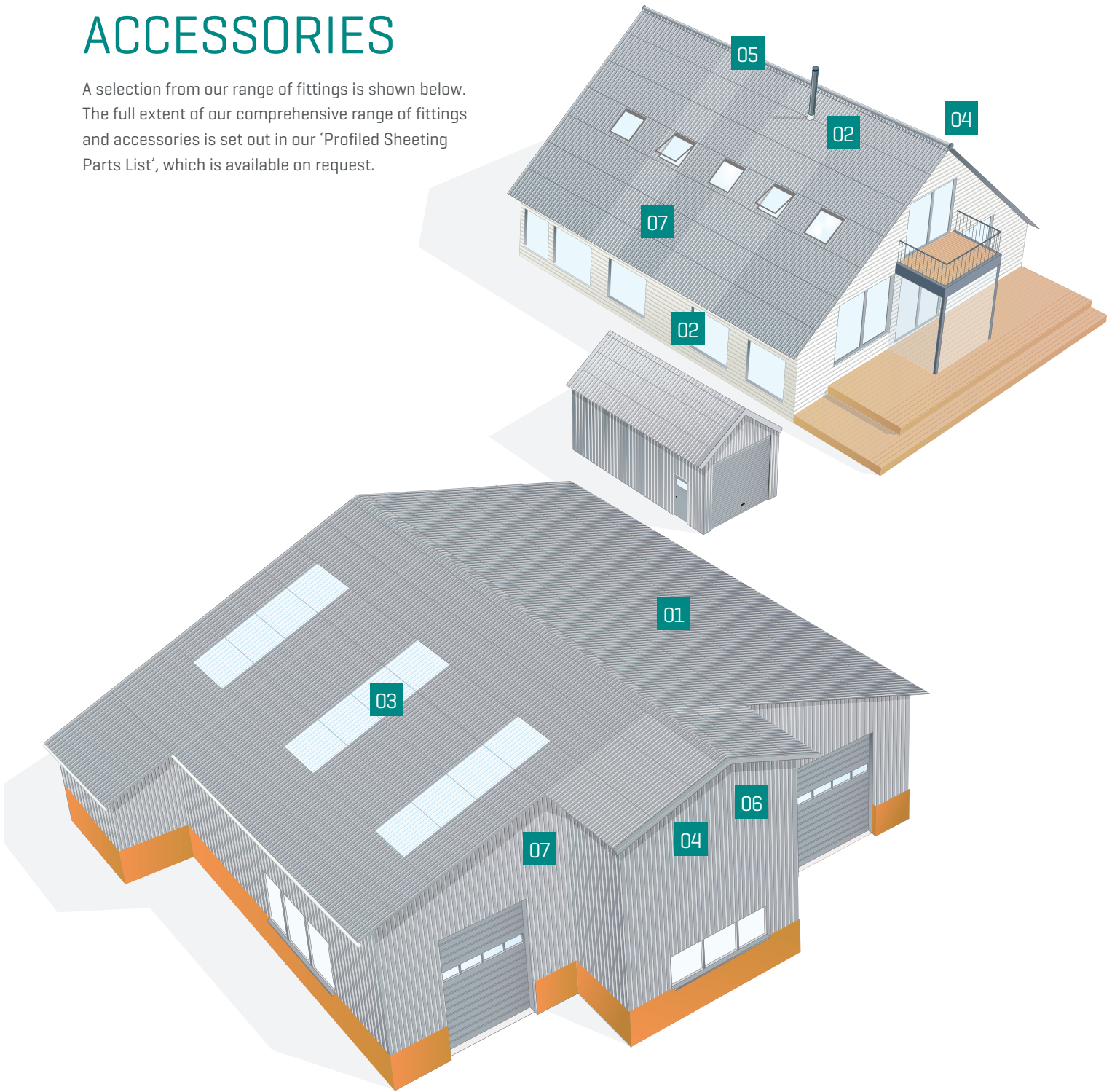

01

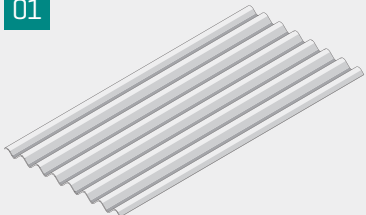

Profile 6
Lengths available: 1220, 1375, 1525, 1675, 1825, 1975, 2125, 2275, 2440, 2600, 2750, 2900, 3050

02



Profile 3
Lengths available: 1525, 2450, 3050

03

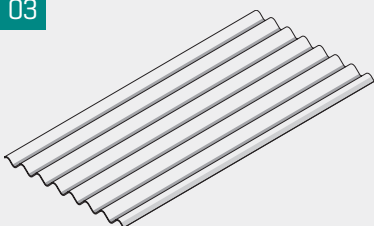

GRP translucent sheet
Profile 6 only

04

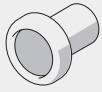

Disc type ridge finial

Available in Profile 6 and Profile 3 to suit two piece adjustable ridges

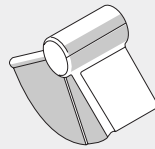

Hooded two piece ridge finial

Profile 6 to suit roll top barge boards

**NEW
Topfix Fixings**

Stainless Steel and Carbon Steel fixing range.

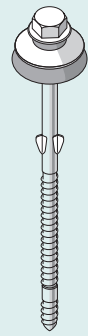

05

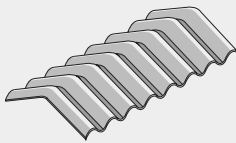

Cranked crown sheet

Profile 6 only, girth 900 and 750 mm. For roof pitches 5° to 22.5° [in 2.5° increments]

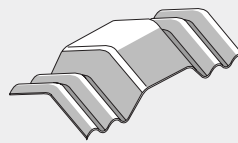

Ventilating cranked crown sheet

Profile 6 only, girth 900 and 750 mm. For roof pitches 5° to 22.5° [in 2.5° increments] For agricultural use only.

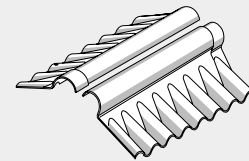

Two piece close fitting ridge

Available in Profile 6 and Profile 3

06

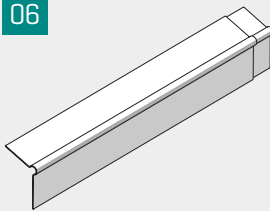

Roll top barge board

Wing dimension 200 mm Length 1525, 2440 and 3000 mm

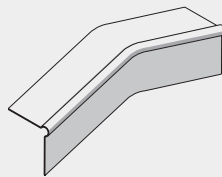

Cranked crown roll top barge board

Wing dimensions 200 mm Girth 1050 and 1300 mm

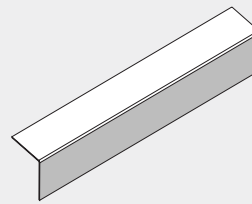

External corner

Wing dimensions 200 and 300 mm Lengths 1800, 2440, 3000 mm

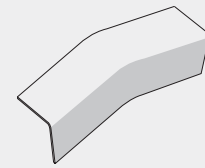

Cranked external corner piece

Wing dimensions 200 and 300 mm Girth 1300 mm

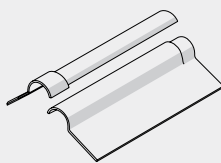

Two piece plain wing ridge

Available in Profile 6 and Profile 3

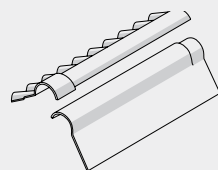

Two piece north light ridge

Available in Profile 6 and Profile 3

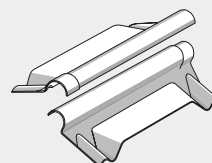

Two piece ventilating ridge

Available in Profile 6 and Profile 3 For agricultural use only

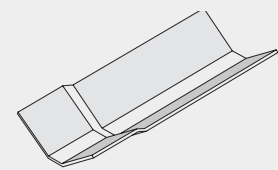

Open protected ridge flashing

Profile 6 only Cover length 2200 mm For agricultural use only

07

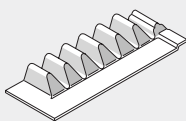

Eaves filler piece

Profile 6 universal, Profile 3 handed

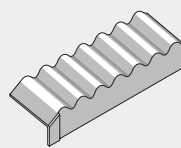

Eaves corrugation closure piece

Available in Profile 6 universal, Profile 3 handed Various back lengths available

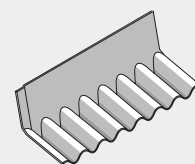

Apron flashing piece

Profile 6 left hand only, Profile 3 right hand only

DESCRIPTION, PROPERTIES AND PERFORMANCE

Identification

Eternit offers a comprehensive range of products fabricated from a man-made fibre formulation, including profiled sheets and fittings.

The range of profiled sheeting products allows design flexibility and speedy construction with overall economy for the roofing and vertical profiled sheeting of all types of buildings, including industrial, commercial and agricultural. It is a material that will comply with the Building Regulations and the Building Standards (Scotland) Regulations.

Quality

Profiled sheeting is manufactured in accordance with a quality system registered under BS EN ISO 9001 and to the European BS EN 494 product specification for Class 1X sheets. Eternit also operate in accordance with Environmental Management System BS EN ISO 14001.

Description

Profiled sheeting is manufactured from Portland cement and water, reinforced with natural and synthetic fibres.

Thickness tolerance

Profiled sheeting thickness tolerance is $\pm 10\%$, but not exceeding 0.6mm, as laid down in BS EN 494.

Impact resistance

The Test for Non-Fragility of Large Element Roofing Assemblies, ACR(M)001, consists of a 45kg bag being dropped from a height of 1200mm onto a fixed sample of roofing. It is intended to provide information about whether the roof can support the instantaneous loads imposed on it by persons stumbling or falling onto it. A roof is classified as fragile if the bag passes through the roof assembly.

If the bag is retained on the test assembly and no other drop tests are carried out, the assembly shall be classified as Class C non-fragile assembly. Profile 6 sheets meet this requirement. The reinforcing strips within Profile 6 only become effective when the sheet is fully fixed.

Sound insulation

The average sound reduction index over the usual measurement frequency range of 100 to 3150Hz has been calculated to be:

- Profile 6 single skin – 28 decibels
- Profile 3 single skin – 27 decibels

Breaking strength

The minimum breaking strength for profiled sheeting is defined under BS EN 494.

The minimum against grain breaking load (purlin to purlin) for Profile 6 is 4250N/m. The minimum with grain bending moment at rupture (ridge to ridge) for Profile 6 is 55Nm/m.

The minimum against grain breaking load (purlin to purlin) for Profile 3 is 1400N/m. The minimum with grain bending moment at rupture (ridge to ridge) for Profile 3 is 40Nm/m.

Installed weight

The approximate installed dry weight of single skin profiled sheeting with fixings and the required side and end laps is as follows:

- Profile 6 single skin – 17.0kg/m²
- Profile 3 single skin – 14.5kg/m²

Fire

Fibre cement sheets are designated SAA rating for roof coverings and Class 0 for wall and ceiling linings in accordance with the Building Regulations. Under the European Fire Test Standards, Eternit fibre cement profiled sheets are classified A2 to BS EN 13501-1:2002 and are considered to fulfil all requirements for external fire performance of roof coverings without the need for testing, in accordance with Commission Decision 2000/553/EEC.

Fibre cement profiled sheeting can be classified as non-combustible under the Building Standards (Scotland) Regulations.

Water tightness

Fibre cement complies with BS EN 494: Clause 5.3.4.



Moisture content

When new, fibre cement sheeting has a relatively high moisture content. If humid conditions prevail, damp patches (without formulation of droplets) may appear on the underside of the sheets. This phenomenon is in no way detrimental to performance and will disappear within 12 months, in the course of natural exposure.

There are two types of fibre cement: fully compressed and semi-compressed. While both meet the same strength requirements, semi-compressed is more suitable for livestock buildings due to its ability to absorb 40% more moisture than fully compressed.

Condensation control

Whilst Profile 6 and Profile 3 are watertight, the sheets have the ability to absorb up to 25% of their dry weight in moisture and dissipate it in more favourable conditions. This material characteristic has a significant effect in reducing condensation occurrence.

Effects of chemicals

Over the years chemical and industrial atmospheric pollution will cause a slight softening of the surface of natural finish fibre cement sheets. The acrylic paint finish provides added protection against many acids, alkalis and solvents normally found in the atmosphere.

Where fibre cement is to be used in particularly aggressive atmospheres, with higher than normal concentrations of acids, alkalis, fats or salts, please contact the Eternit Technical department for advice.

Biological

Profiled sheeting is vermin and rot-resistant, but lichen may grow on the outer surface. For advice on removal, please contact the Eternit Technical department.

Light reflectance

Mean results for natural grey sheets are 40% dry and 16% wet, using magnesium carbonate as 100%.

Effects of low and high temperature

Profiled sheeting is designed to be minimally affected by frost or climatic temperature changes.

For buildings in which higher than normal temperatures occur, or in areas which are expected to be subjected to sudden changes in temperature, special considerations may be necessary. [Consult the Eternit Technical department for recommendations].

Thermal and other movements

The amount of movement is negligible, but it is necessary to provide movement joints in association with the structural framework. [For details of movement joints, see pages 66-67]. The co-efficient of linear expansion for profiled sheeting is $8 \times 10^{-6} \text{m/mK}$.

Thermal conductivity

Profiled sheeting has only low thermal conductivity when compared with other sheet roofing products. This serves to reduce heat build up in summer and heat loss in winter.

Thermal conductivity = 0.48 W/mK.

Durability

In normal atmospheric conditions, profiled sheeting may be regarded as having a normal life of at least 50 years, but the durability of the fixing accessories should be taken into account.

Atmospheric pollution is not normally sufficiently concentrated to be harmful. Measures should be taken to prevent corrosion of the fixing accessories, e.g. by the use of plastic washers and caps.

Profiled sheeting is resistant to most forms of atmospheric attack but, with age, becomes less elastic and a small deflection will be experienced, which may make it less resistant to impact. Its transverse strength, however, is maintained.

Maintenance

Profiled sheeting in natural grey finish requires no routine maintenance. Decorative or preservative treatment should be renewed or treated as necessary.

Fixings and washers may, however, deteriorate and should be inspected at intervals according to the type of fixing and degree of exposure.

Appearance

When a painted finish is applied, the colour intensity will reduce due to weathering, but when the roof is viewed from a reasonable distance the colour intensity will appear harmonious.







PROFILE 6 DETAILING

Ridges	52
Eaves	54
Bargeboards	56
Translucent sheets	58
Movement joints	60
Vertical cladding	62
Miscellaneous fittings	64
Roof windows	65
Photovoltaics and profiled sheeting	65
Insulated systems	66
Ventilation	67

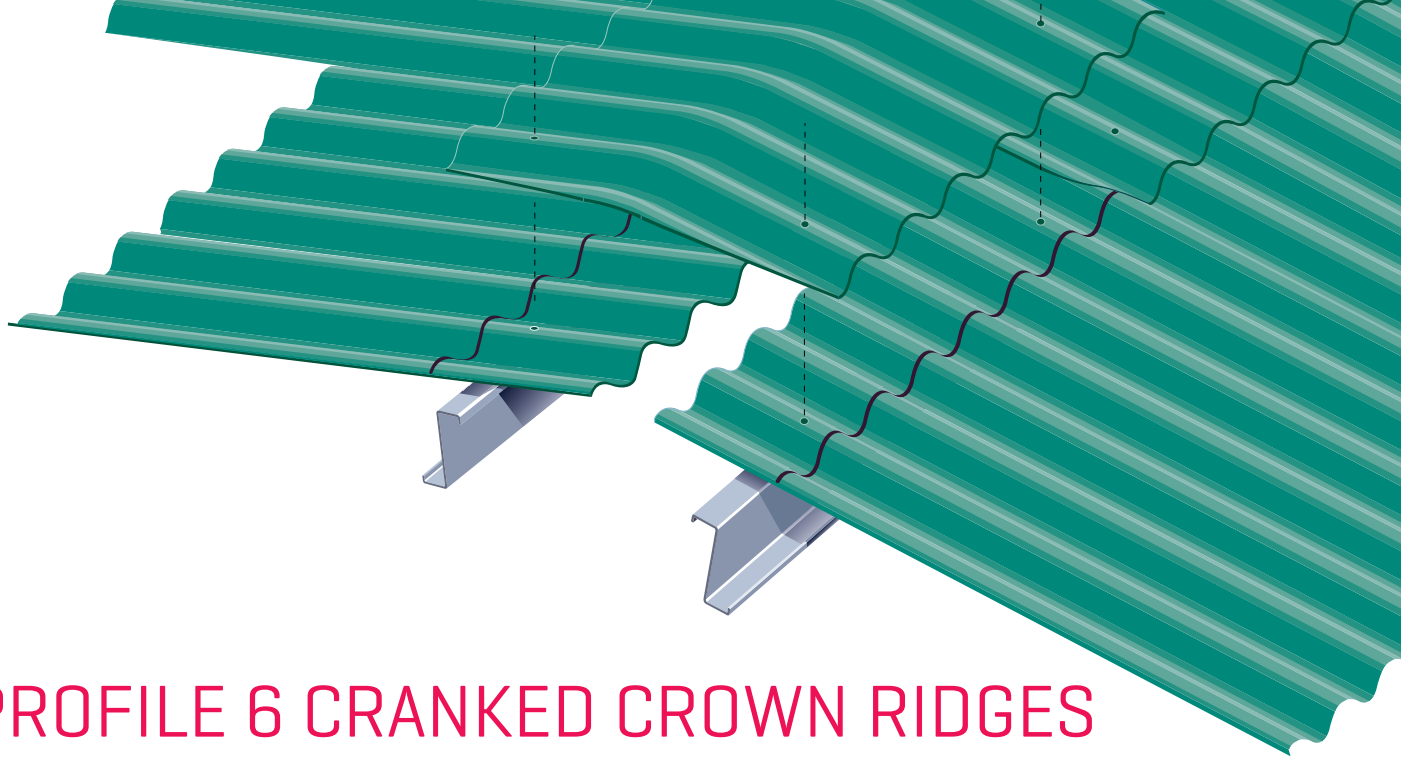

PROFILE 6 CRANKED CROWN RIDGES

Cranked crown ridge pieces are one-piece fittings for closing off Profile 6 sheeting at the crown of a roof.

They are made with an accurate profile, giving a precise fit and are manufactured in pitches of 5° to 22 1/2° in 2 1/2° increments. These sheet pitches can be used with any roof pitch from 5° to 23 1/4°. [See table].

Available girths are 750 and 900mm.

Before laying cranked crown ridge pieces, it is important to ensure that the sheets on both roof slopes are aligned correctly.

The ridge purlins should be positioned so that the fixings are located not less than 100mm from the ends of the cranked crown ridge pieces [see Figs. 1 and 2].

To form a non-fragile ridge detail, the cranked crown should be lapped by 300mm onto the sheeting on each side of the ridge.

Where cranked crown ridge pieces overlap, both the cranked crowns and the lower sheets are to be mitred on each roof slope.

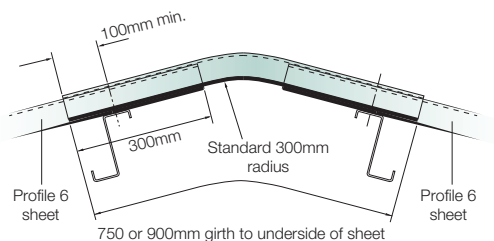

Fig.1 - Cranked crown fixings

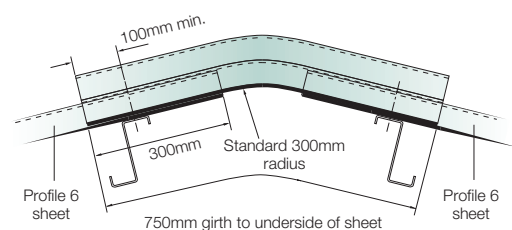

Fig.2 - Ventilating cranked crown fixings

Cranked crown sheet pitch	Roof pitches	
	from	to
5°	5°	5 3/4°
7 1/2°	6°	8 1/4°
10°	8 1/2°	10 3/4°
12 1/2°	11°	13 1/4°
15°	13 1/2°	15 3/4°
17 1/2°	16°	18 1/4°
20°	18 1/2°	20 3/4°
22 1/2°	21°	23 1/4°

Note: The cranked crown ridge pieces, if fixed in the position shown in Figs. 1 and 2, will meet the non-fragility requirements of HSG 33.

When 750mm girth cranked crown and cranked vents (Fig. 2) are used on roof pitches of 15° to 22 1/2°, the 300mm overlap encroaches onto the curved part of the cranked crown ridge. In order to avoid damage, an 8mm butyl strip should be used as a spacer between the top of the sheet and the underside of the cranked crown unit.

General methods of application

Figs 1 and 2 are typical details which, using the same principles, can be applied to situations other than those illustrated.

Ventilating cranked crown ridge pieces

These match in with cranked crown ridge pieces and give ventilation whilst providing reasonable weatherproofing.

They may be used in continuous runs, or intermittently with plain cranked crown ridge pieces. If used in continuous runs, provide one standard cranked crown ridge piece at each end of the building.

Ventilation area of the cranked vent is 68,350mm² per ridge

Purlin position

Note that the purlins can be positioned up slope from the position shown in Figs. 1 and 2.

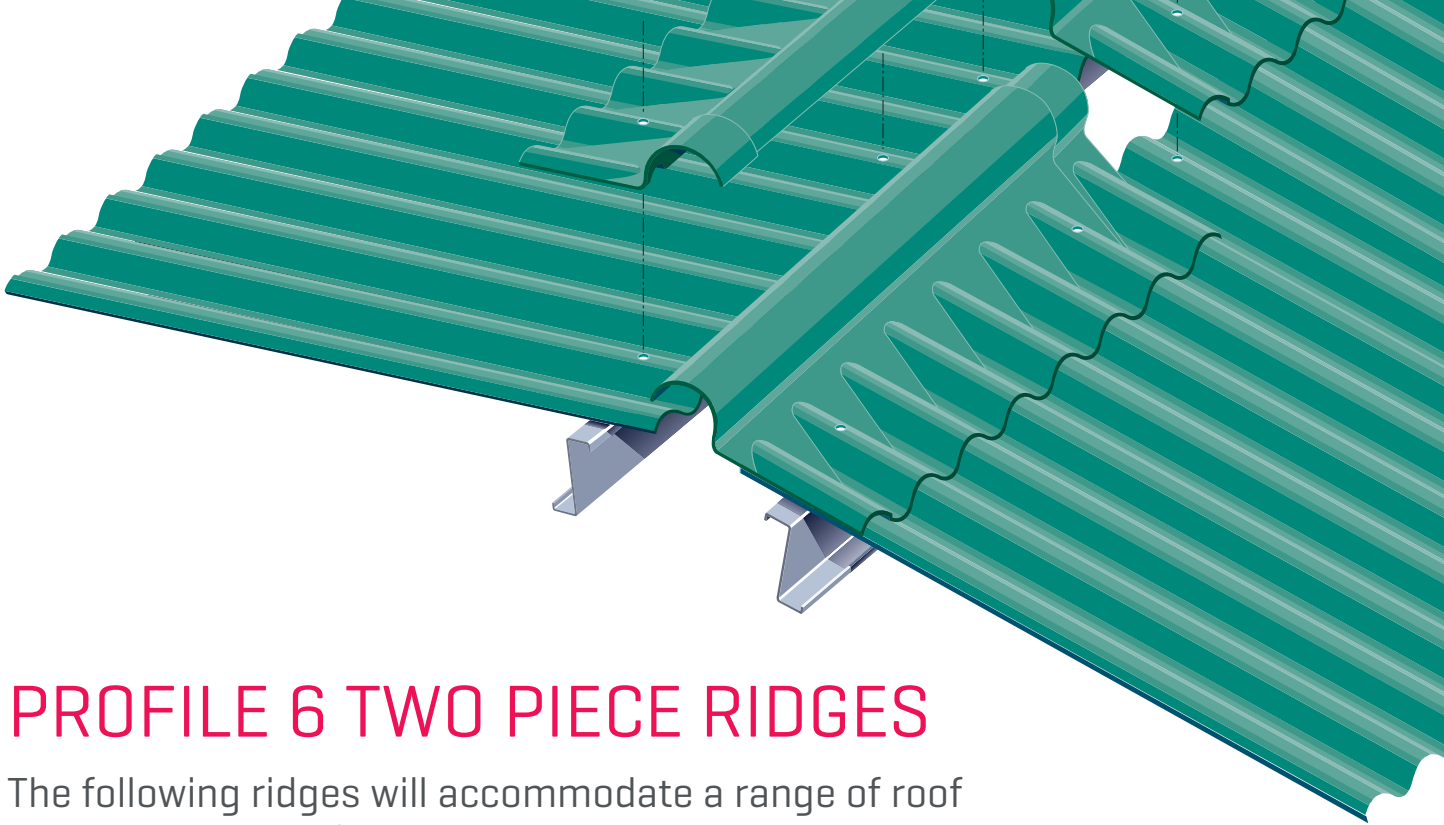

PROFILE 6 TWO PIECE RIDGES

The following ridges will accommodate a range of roof pitches because of their adjustable two piece construction.

Each ridge gives a net covering width of 1016mm, to match the Profile 6 sheeting.

All ridges should be fixed directly to the purlins, through the crowns of the corrugations of the roof sheeting.

Single skin roofs

Two piece close fitting ridge [Fig.1]

It is essential that the two sides of the roof sheeting be aligned correctly before fixing of the close fitting ridge is attempted. [For details of laps of ridge pieces, see the positioning drawings opposite.] For dimensions see notes below.

Two piece plain wing ridge [Fig.2]

This ridge gives a neat finish to a roof apex. Easily fixed, it provides adequate weather protection, but does not close off the corrugations of the roof sheeting, thus allowing a measure of ventilation.

Two piece ventilating ridge [Fig.3]

This matches in with the close fitting ridge, but gives ventilation whilst providing reasonable weatherproofing. Positioning and fixing are as for the close fitting ridge.

When used in continuous runs, one pair of close fitting ridges should be laid at each end of the run to provide a neat finish at each verge.

Northlight ridge

This has one large roll close fitting ridge and one small roll plain wing ridge.

Notes: For Figs.1-4, the gap between the sheets at the apex should not be greater than 150mm. When fitted as shown above, the three ridge types will meet the non-fragile requirements of HSG 33.

When fitted in accordance with Eternit recommendations, the free air area provided by these units are as follows.

- Two piece ventilating ridge: 33,670mm² per pair
- Two piece plain wing ridge: 46,470mm² per pair

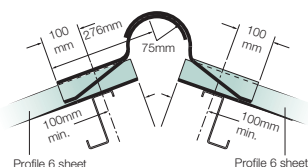

Fig.1 - Two piece close fitting ridge

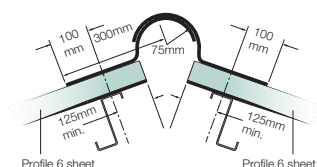

Fig.2 - Two piece plain wing ridge

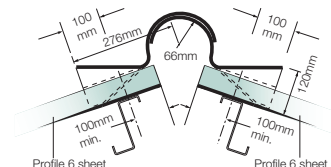
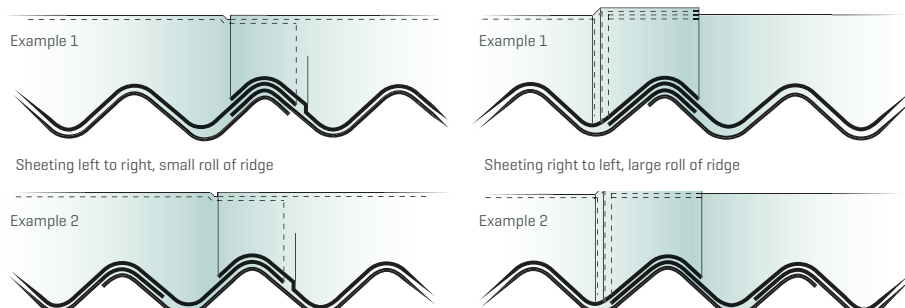

Fig.3 - Two piece ventilating ridge

Fig.4 - Position of two piece ridges



PROFILE 6 EAVES BEND SHEETS

Eaves bend sheets provide a neat, simply detailed transition from profiled roof sheeting to vertical cladding of the same profile.



For single skin roofs

They are supplied in a standard girth of 1525mm, and are available to suit roof pitches of 5° to 22 1/2° in 2 1/2° increments.

The positioning of the purlins and rails is critical to achieve a non-fragile eaves construction. The most common fixing detail, illustrated below, is a fragile construction unless other measures are taken to prevent someone falling through the roof. Please contact us for further information.

Fixing eaves bend sheets

Eaves bend sheets should be installed in sequence in a vertical tier of sheets from the base of the profiled sheeting to the apex of the roof.

They should be mitred as detailed for the roof sheeting, see page 34.

Eaves bend sheets should only be fixed to the lowest purlin of the roof slope and to the top rail of the vertical profiled sheeting.

Note: For advice on recommended methods of fixing Profile 6 sheets on vertical profiled sheeting, refer to pages 62-64.

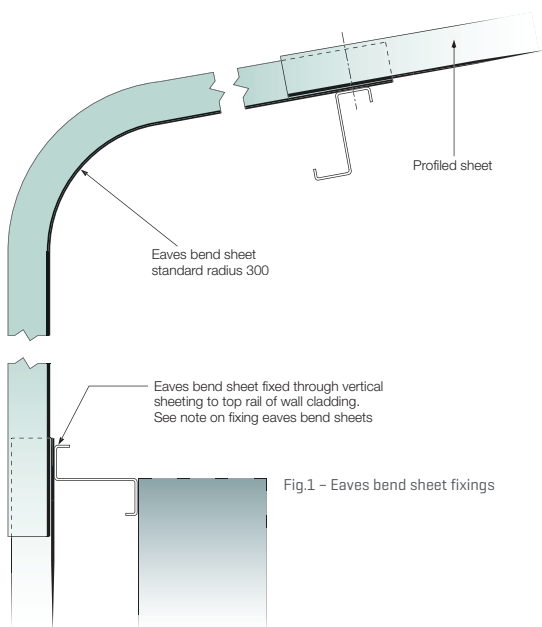

PROFILE 6 EAVES CLOSURE PIECES

Eaves closure pieces are designed to close the corrugation/insulation spaces at the eaves and form a downturn into the gutter, ensuring a barrier against wind-driven rain. Profile 6 closures are universal (not handed).

Single skin roofs

Positioning eaves closure pieces

Before sheeting commences, ensure that the purlin at the eaves is correctly positioned to give the required overhang of the sheeting over the gutter. The maximum unsupported overhang for Profile 6 sheets is 350mm.

Each eaves closure piece is fixed at two points, either with the main roof fixings directly to the lowest purlin, or with secondary fasteners to the roof sheets.

When fixing eaves closure pieces, consideration must be given to the position of the back [see Fig.3] in relation to the gutter. Position the back as tightly as possible against the gutter or vertical profiled sheeting to reduce draughts and restrict driving rain, sleet or snow from penetrating the interior of the roof.

When ventilation into the roof void is required, a slight gap can be allowed between the back of the closer and the vertical profiled sheeting.

For single skin applications, closers with 65mm or 100mm back are typically used.

Closers with 150mm and 250mm back are also available for insulated constructions.

Valley gutter detail with eaves closure pieces (Fig. 1)

Eaves closure pieces can be used at a valley gutter. Ideally, they should be fixed with the main sheet fixings, but they can also be stitched to the sheets with secondary fasteners.

Eaves filler pieces (Fig. 2)

These units close the corrugations of the roof sheeting at the eaves and provide a continuous flat soffit to the underside of the roof sheeting for close sealing to the top of a wall or the edge of a gutter. Profile 6 eaves filler pieces are Universal, and should either be screwed directly to the purlins or the wall plates along with the roof sheeting, or stitched to the roof sheets with the appropriate fixings.

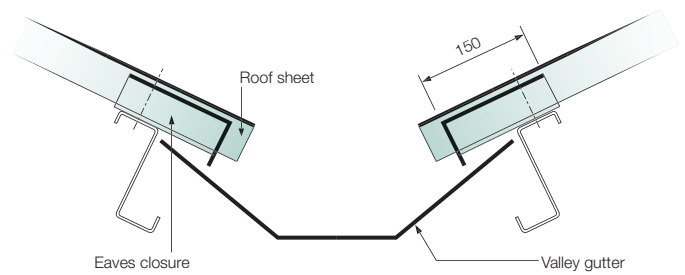
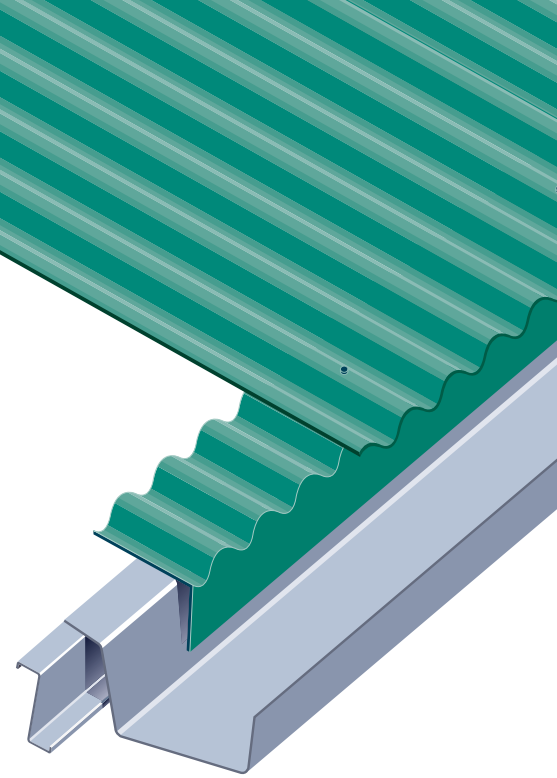

Fig.1 - valley gutter fixings

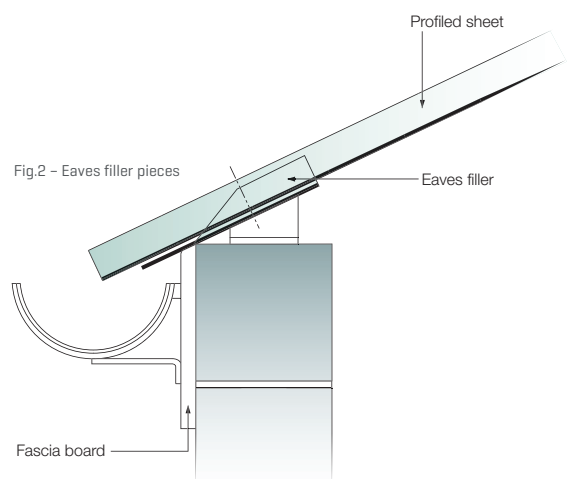

Fig.2 - Eaves filler pieces

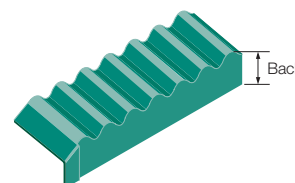

Fig.3 - Eaves closure

PROFILE 6 BARGEBOARDS

The range of profiled sheeting bargeboards provides a choice of weatherproof finishes to the verges of a building. With each bargeboard, one leg extends across the roof sheeting while the other covers the top of the masonry wall or vertical cladding.

Bargeboards are fixed with topfix fasteners to the purlins and also screwed to the wall or vertical cladding.

Eaves bend bargeboards are available to suit eaves bend sheets in 1575mm girth and are available for roof pitches from 5° to 22 1/2° in 2 1/2° increments.

The sheets should project the maximum distance under the bargeboard to provide the optimum weather protection.

Handing of bargeboards

Vergeline bargeboards and any eaves bend bargeboards are handed, as viewed from the gable end. Roll top and plain wing bargeboards are universal, as are all cranked crown bargeboards.

Any reduction in length should be made from the non-socketed end.

Fixing bargeboards

Bargeboards should be positioned so that their lap is directly below the end lap of the sheeting, with the top of the underlapping bargeboard close to the tail of the sheet in the course above. When the gable is brick or block, position the bargeboard 25mm clear of the face of the wall. Fix both legs of the bargeboard to the roof and the wall at all purlin positions. Intermediate fixings should be introduced as necessary to ensure that the bargeboard fixings are at 750mm maximum centres. [Figs.1-3].

Note: As the verge is the part of the roof that is often the most vulnerable to wind damage, more fastenings are required there to ensure that bargeboards in general and the ends of the bargeboards in particular are always securely fixed.

Built up systems

Please contact Eternit for further details.

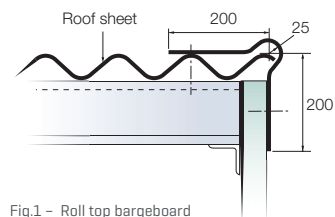

Fig.1 - Roll top bargeboard

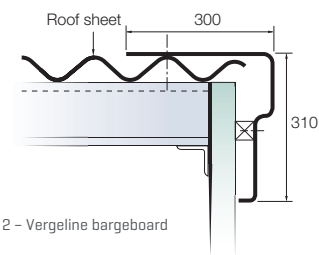

Fig. 2 - Vergeline bargeboard

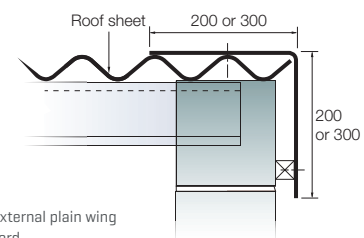
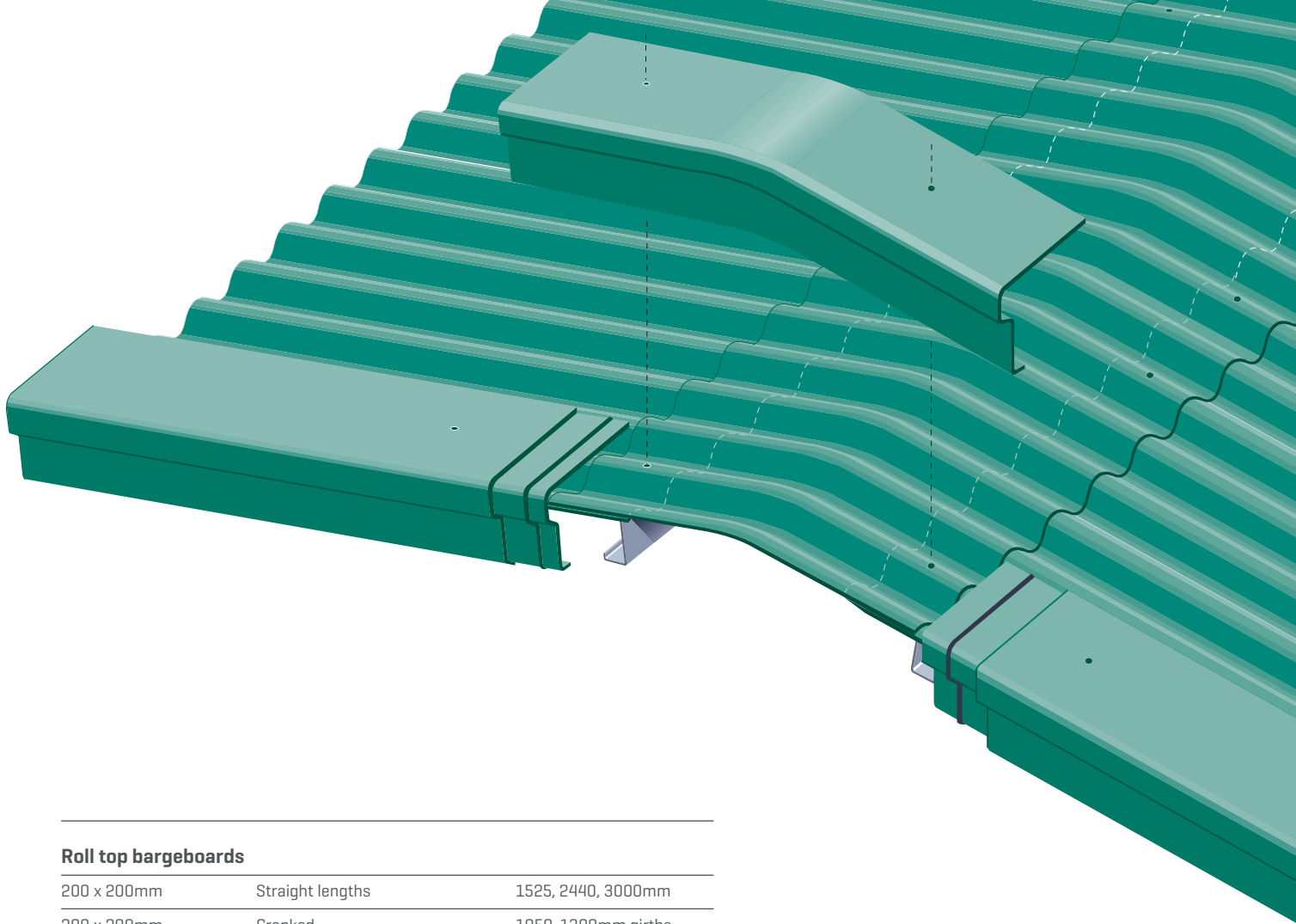

Fig.3 - External plain wing bargeboard



Roll top bargeboards

200 x 200mm	Straight lengths	1525, 2440, 3000mm
200 x 200mm	Cranked	1050, 1300mm girths
200 x 200mm	Eaves bends 5°-22½° in 2½° increments	1575mm girth

Roll top bargeboards (Farmscape)

200 x 200mm	Straight lengths	1525, 2440, 3000mm
200 x 200mm	Cranked 10°, 12½°, 15°, 17½°	1050mm girth

Vergeline bargeboards (handed)

300 x 310mm	Straight lengths	1800, 2400, 3000mm
300 x 310mm	Cranked crowns 5°-22½° in 2½° increments (Farmscape 10°, 12½°, 15°, 17½°)	1300mm girth

Plain wing bargeboards

200 x 200mm	Straight lengths	1800, 2440, 3000mm
300 x 300mm	Straight lengths	1800, 2440, 3000mm
200 x 200mm	Cranked	1300mm
300 x 300mm	Cranked 5°-22½° in 2½° increments	1300mm

PROFILE 6 TRANSLUCENT SHEETS

Eternit can supply GRP Translucent sheets that meet the requirements of ACR(M)001:2014, and have a fire rating of SAB Class 3. Other grades of rooflights are available in different materials from rooflight manufacturers.

Translucent sheet rooflights are laid unmitred, and since the problem of compound layers at end lap situations does not occur, adjacent fibre cement sheets are also left unmitred at these junctions.

Eternit single skin rooflights

Material	2.4kg/m ² GRP
Fire Rating	SAB Class 3
Fragility	Non - fragile Class C to ACR(M)001:2014 when new and fully fixed in accordance with Eternit recommendations
Lengths	1525, 2440, 2900, 3050mm

The translucent sheets should be supported at each purlin position by profiled fillers, fibre cement sheets, or fibre cement closure pieces [Fig.1].

End laps and side laps should be sealed with 10mm diameter extruded mastic sealant.

Self-sealing fasteners with a synthetic rubber shank or seam bolts and washers with wide bearings are recommended at 300 - 400mm centres for side stitching. Self-tapping screws and blind rivets should not be used for stitching side laps.

Translucent sheets should be fixed through every corrugation (not including the side laps) to the purlins [Fig.2]. The same fixings are used as for fibre cement sheeting, but the holes for GRP translucent sheets should be 2mm oversize, and for polycarbonate sheets 6mm oversize [for sheet lengths up to 2m, otherwise 9mm oversize].

All recommendations of the specialist translucent sheeting supplier should be carefully observed. The fixing recommendations will vary depending on the type, grade and supplier of the material being used.

It is advisable to use weatherproof caps and washers where possible, that are a distinctly different colour to the fixings for the rest of the roof. Conventionally, poppy red caps are used for rooflights.



Double skin rooflights

Double skin rooflights can be either Factory Assembled Insulating Rooflights (FAIRs), or site-assembled. For full details, consult the manufacturers.

Site-assembled rooflights

Site-assembled rooflights are commonly installed when using a liner sheet and quilt insulation.

In double skin constructions, all four edges of a translucent sheet or area should have rigid foam supports/closures provided at the laps with the fibre cement sheets. Support pieces should also be installed where translucent sheets pass over intermediate purlins.

Laylights

A double skinned flat box, made to the same dimensions as the rigid insulation, can be obtained. The joints between the double skinned box and the insulation board are sealed with foil backed acrylic adhesive tape 50mm wide to create a vapour proof check within the building. Installation of the weathering sheets above this, in effect, creates a triple skin.

Factory Assembled Insulating Rooflights (FAIRs)

FAIRs are delivered to site ready to install. Packing may be needed at intermediate purlins, if the air gap in the FAIR is not as deep as the insulation. Always follow the manufacturer's fixing recommendations.

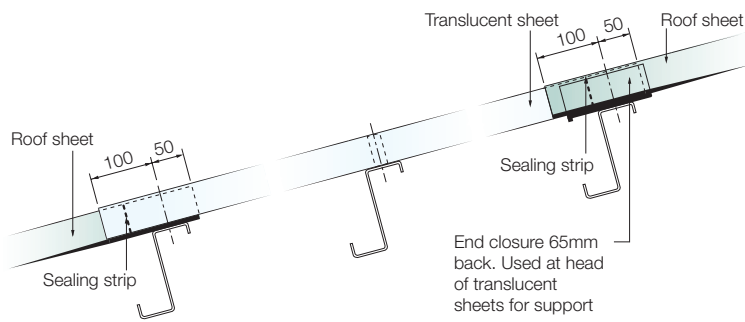
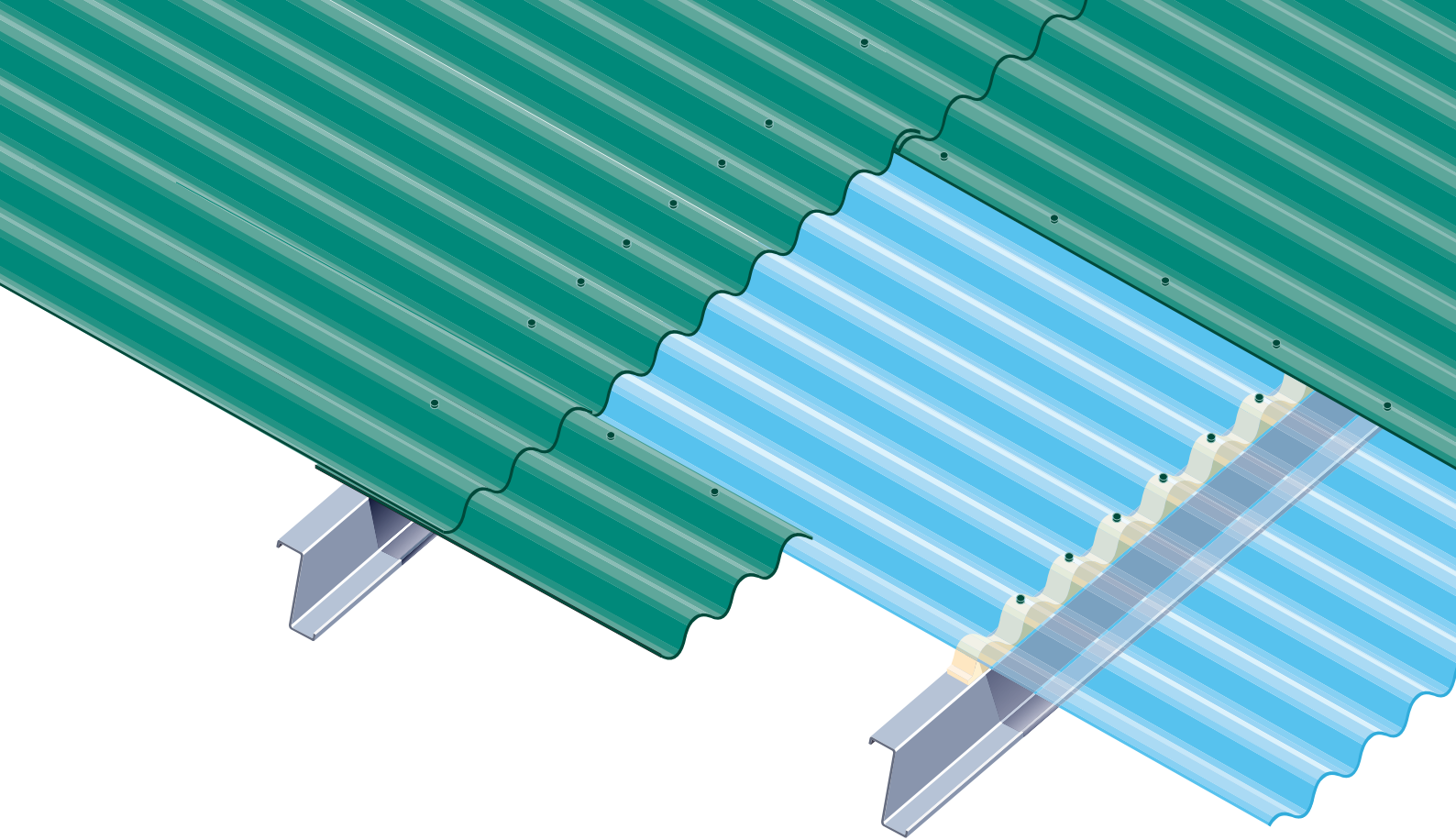

Fig.1 - End lap details for translucent sheet rooflights

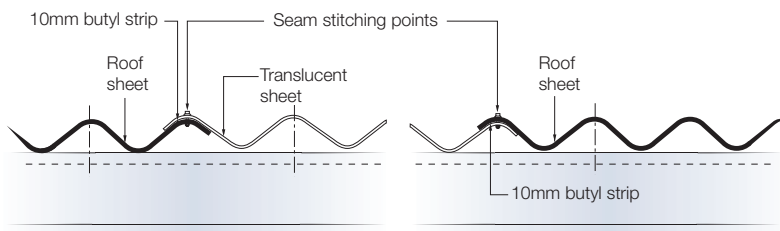

Fig.2 - Side lap detail for translucent sheet rooflights

PROFILE 6 MOVEMENT JOINTS

Components

- Straight movement joint pieces (lengths: 1525, 2440, 3000mm)
- Cranked crown movement joint pieces (length: 1300mm)
- Movement joint stop ends
- Movement joint two piece ridge caps (see illustration opposite)

Forming movement joints

Where the movement joint is to be formed, each sheet is cut through the valley at the centre of the sheet, and the resulting pair of half sheets spaced 25 to 30mm apart.

The movement joint should be laid with the top end butting up to the bottom edge of the next sheet upslope allowing a min. 150mm lap.

The movement joint pieces are fixed to the purlins using the same method of fixing as the roof sheets, with one fixing in the centre of the movement joint at each purlin run. This fixing should pass through the gap between the two half sheets and must not be overtightened. (Figs.1 and 2).

Movement joint cranked crown caps

Cranked crown caps are available in a range to suit the standard Profile 6 cranked crown ridge pieces. When laying cranked crown ridge pieces, form a 25 to 30mm movement gap as detailed opposite and cover it with the crown cap, screwing this directly to the ridge purlins. Note that when laying the straight movement joint, the top end should butt up to the overlap of the cranked crown ridge piece. The crown cap, being longer than the crown ridge piece will then correctly overlap the straight movement joint.

Movement joint stop ends

Intended to close the open end of a movement joint, stop ends are made to fit over the sheeting and into a straight movement joint. They should be fixed by bolting to the movement joint.

Movement joint ridge caps

These are used in the same way as movement joint cranked crown caps, but designed to fit two piece close fitting ridges (Fig.3).

Applications

Movement joints are intended for use in long, continuous stretches of roofing or vertical sheeting, to accommodate thermal and other movements. BS 8219 recommends that movement joints be included in stretches of roofing and vertical sheeting on buildings exceeding 45 metres in length.

They should also be designed to coincide with any structural or movement joints provided in the building, in which case, there should always be a movement joint through the complete system.

For buildings in which the temperature or humidity is higher than normal, or which are subjected to sudden changes in temperature, the movement joints may be required at closer centres than indicated. Contact the Eternit Technical department for further advice.

Movement joints for single and built up roofs

Recommended spacings	
Length of building	Number of movement joints
0-45m	0
45-75m	1
75-105m	2

Plus one extra movement joint for every additional 30m.

For built up roofs

The movement joint is generally only required to allow differential movement of the fibre cement sheets, and there is no requirement for a movement joint in the lining panel or insulation system.

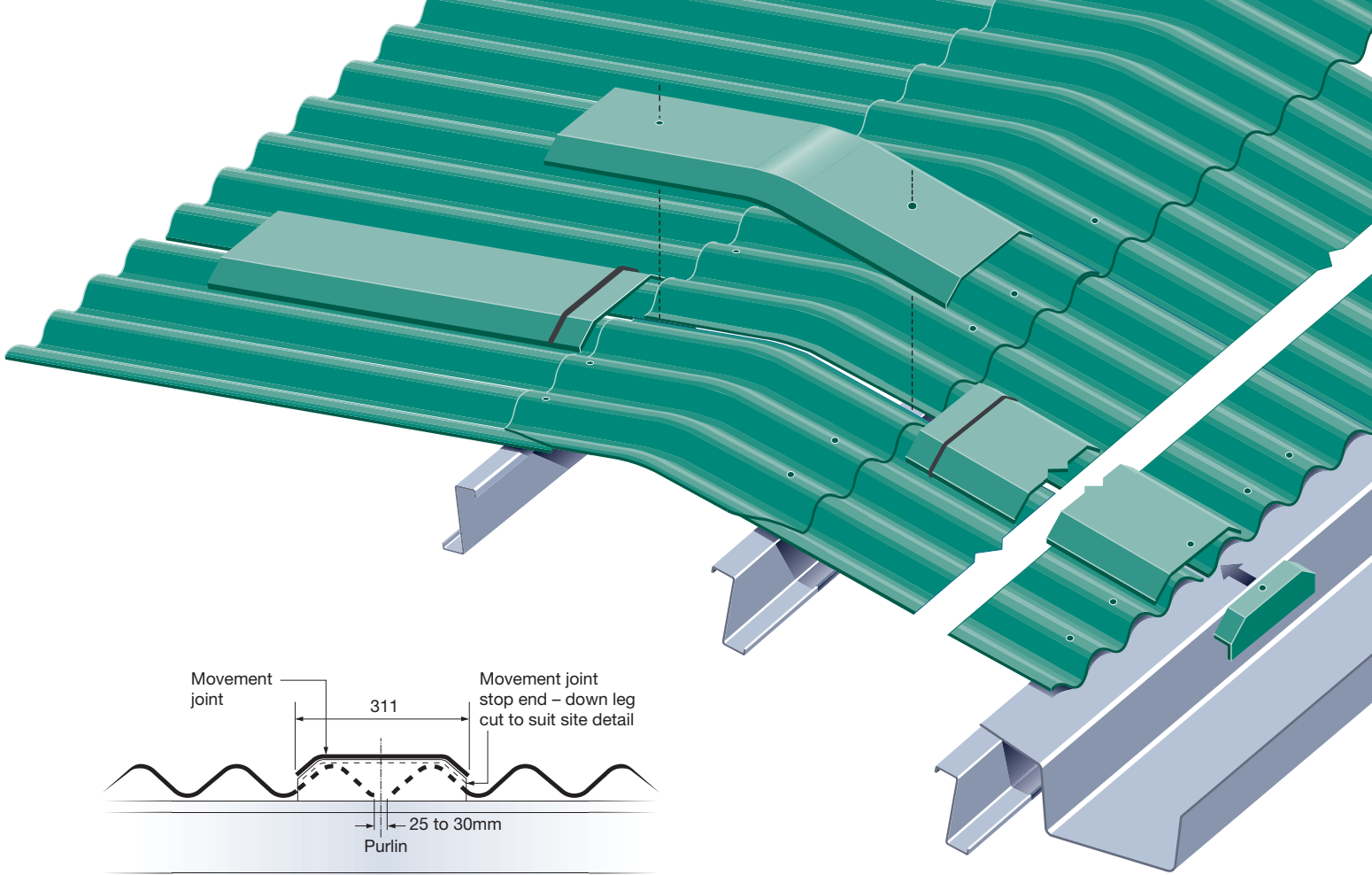

Fig.1 - Movement joint end elevation

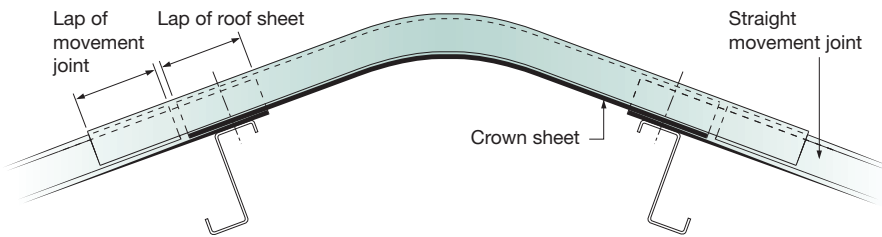

Fig.2 - Movement joint side elevations

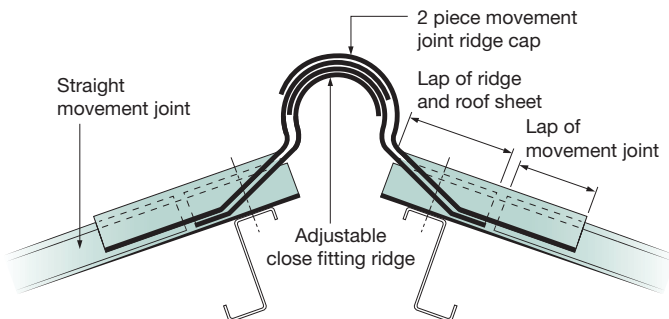

Fig.3 - Movement joint ridge cap

PROFILE 6 VERTICAL CLADDING

Profiled sheeting can be used in a wide range of vertical details for agricultural, industrial and residential applications.

Top Fix Systems

When fixing Profile 6 using topfix fasteners on a vertical application, some provision must be made to support the weight of the sheets, otherwise the sheets will sag down from their intended position and both the fasteners and the fibre cement will be overstressed.

The base of each sheet should be supported on two support clips which hook over the sheeting rail. The support clips should be positioned in the valley corrugations adjacent to the fixing position.

Valley fasteners

An alternative solution, which doesn't require the support clips, is to fix the sheets in the valley corrugations. The sheets should be pre-drilled with a 2mm oversize hole. The following fasteners (available from Fixfast) are suitable for valley fixing Profile 6 sheets.

Rail type	Carbon steel fasteners	Stainless steel fasteners
Hot rolled steel	DF12-5.5 x 80 with FCW washer	n/a
Cold rolled steel	DF3-5.5 x 55 with FCW washer	DF3-SS-5.5 x 55 with FCW washer
Timber	DFT-5.5 x 65 with FCW washer	DFT-SS-6



Double skin applications

Please contact the Eternit Technical department for further details.

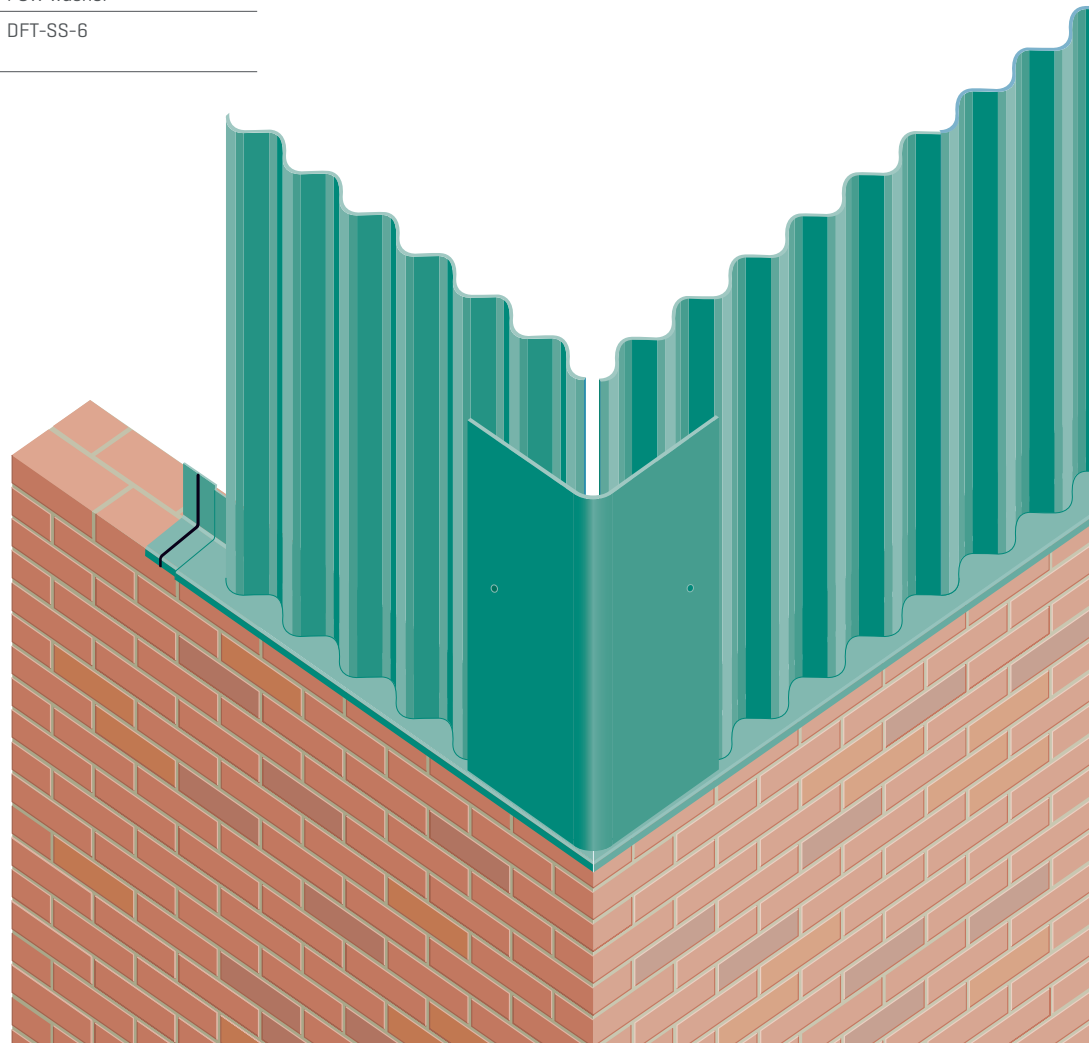

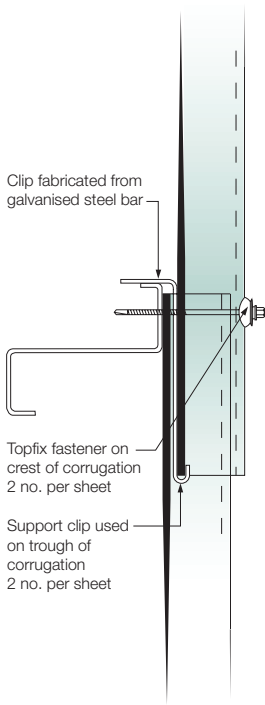

Fig.1 - Single skin vertical profiled sheeting

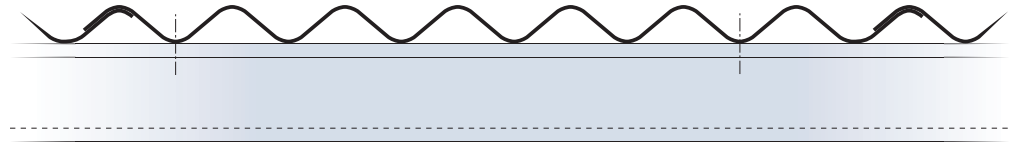

Fig.2 - Valley fixing positions

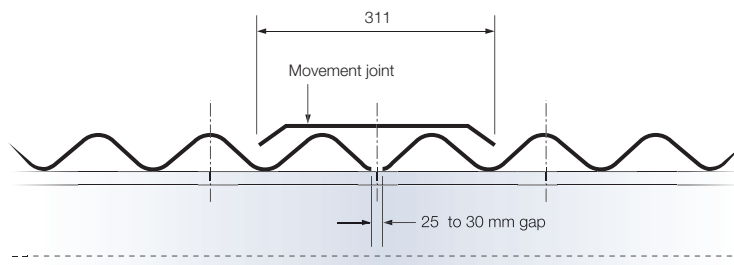

Fig.4 - Vertical movement joint

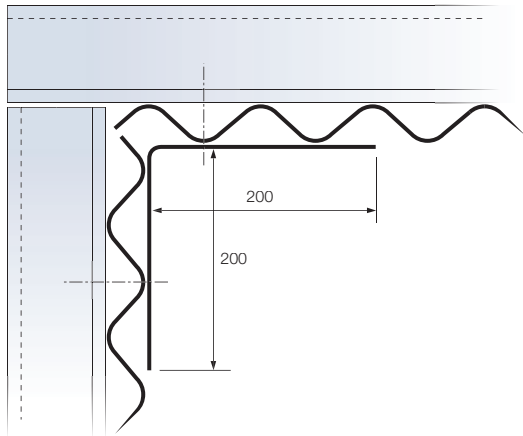

Fig.3 - Internal corner section

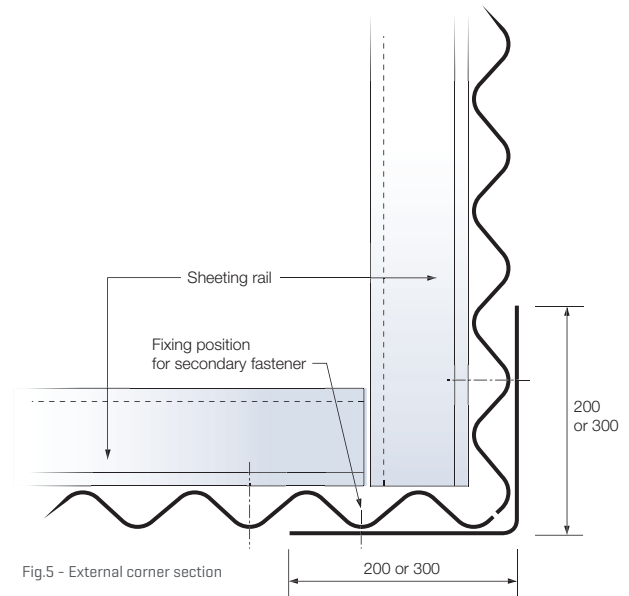

Fig.5 - External corner section

PROFILE 6 VERTICAL CLADDING – SINGLE SKIN WALLS

Jamb fillers

With two flat wings set at right angles, jamb filler pieces give a neat finish to the sides of door and window openings. The broad wing is fitted behind the vertical sheet and the narrow wing then presents a flat surface at the side of the opening. For single skin profiled sheeting, a 70mm nib is provided. Screw directly to steelwork or stitch to corrugated sheeting with seam bolts. [Fig.1]

Fig.1 – Jamb filler

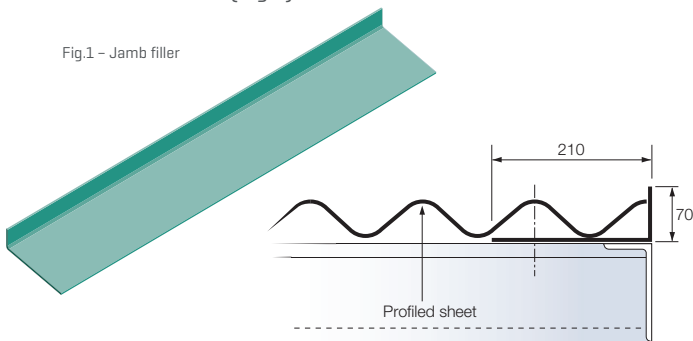

Lintel fillers

Lintel filler pieces [eaves closure pieces], close the corrugations of vertical sheeting above door, window or other openings. A choice of backs is available from 65 to 250mm and the fitting is universal. Fix by screwing directly to the structure in conjunction with sheeting or by stitching to the sheeting with seam bolts. Fig. 2 shows a typical single skin detail with a 65mm back.

Fig.2 – Lintel filler

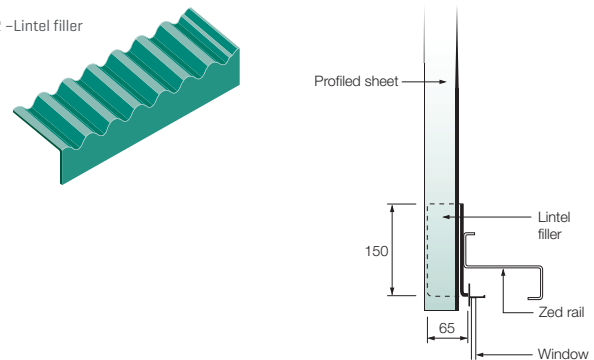

PROFILE 6 MISCELLANEOUS FITTINGS

Under glazing flashing pieces

Fixed on top of roof sheets below a run of glazing, these fittings considerably reduce the amount of metal flashing required by presenting a flat surface to receive the flashing. Under glazing flashings are socket jointed and are fixed on each side of the lap. They can also be used to close off vertical sheeting at eaves or sills. Under glazing flashing pieces are handed. [Fig.3].

Fig.3 – Under glazing flashing pieces

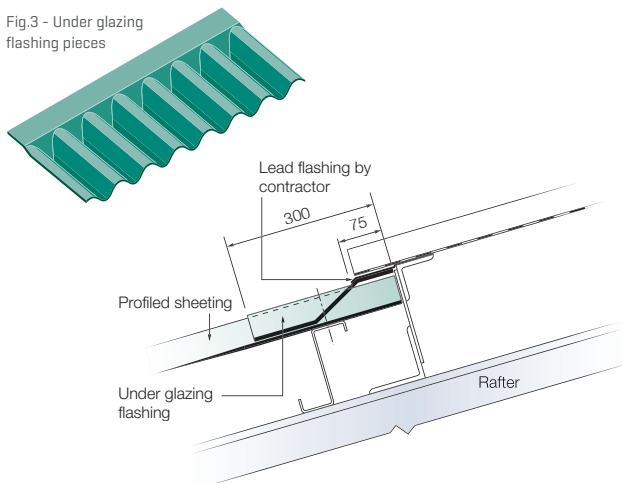

Apron flashing pieces

Apron flashing pieces consist of a corrugated wing with a flat apron. Typical uses are: flashing between a lean-to roof and vertical abutment; flashing to jack-roof, and flashing under louvre blades. Lap over the top of the roof sheets and fix either side of the lap. Apron flashing pieces are made with a standard left-hand socket and can be used on sheeting laid either left to right or right to left by varying their position relative to the side lap of the sheeting as per the small roll ridge fitting detailed in Example 1 on Page 51.

Fig.4 – Apron flashing piece

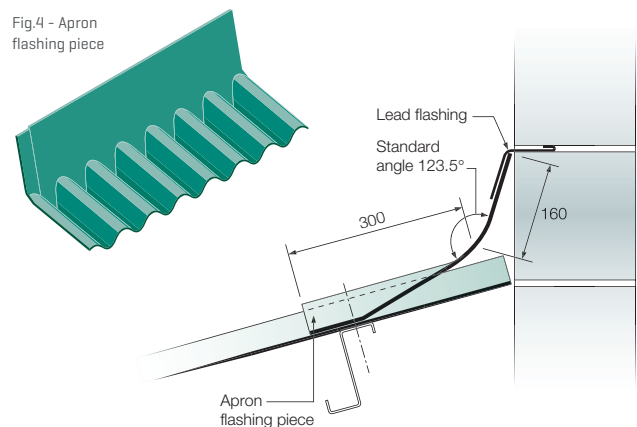

PROFILE 6 ROOF WINDOWS



Roof windows can generally be incorporated into a profile sheeted roof provided they have a flashing kit suitable for the depth of profile. It is, however, important that the positions of the windows are coordinated with each other and with the sheeting layout at an early stage of the design.

It is important that there is a sheet lap immediately below the roof window so the malleable flashing can dress over the course of sheets below, before the sheets to the side of the window are installed. It is preferable, but not essential that there is a sheet lap immediately above the window.

The windows should be positioned to avoid a narrow strip of sheet to the side of the rooflight.

If the water barriers on the flashing kit are not deep enough to provide a weathertight detail, particularly when considering wind driven snow, Eternit may be able to provide some solutions.

PHOTOVOLTAICS AND PROFILE SHEETING

There are various types of fixing systems for PV panels, most of which have brackets fixed through the fibre cement sheets to the purlins.

In some cases, this method of fixing can affect the long term performance of the roof covering so a preferred solution is to fix a secondary framework above the roof sheets. A series of stub columns can be fixed on top of the structural frame to support a secondary rafter above the roof surface; the PV framework can then be fixed to this secondary rafter. The holes through the sheeting for the stub columns should be weathered with pipe flashings, possibly in conjunction with a metal apron flashing that extends up to the ridge.

When selecting a fixing method for PV panels, the following points should always be considered:

- Fibre cement profiled sheets should always have 2 fasteners per sheet width per purlin, the fixing positions being in the first full corrugation on each side of the side lap. There should be no additional fasteners fixing the sheets to the purlins. The fasteners should be fixed through 2mm oversize holes in the sheet to allow for expansion/contraction and differential movement.
- The roof structure should be designed for the additional loading of the PV system, and also for possible additional snow loadings as the PV panels could increase the build up of snow. It has been shown that there may also be an increase in wind loadings after PV panels have been fitted to a roof.

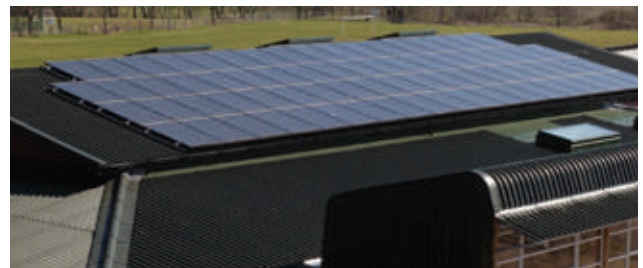

- The additional loading on top of the profiled sheet will increase the downslope loadings on the fasteners and rotation of the purlins. Can the fasteners withstand this loading? Where Zed purlins are used, is the purlin thickness adequate to prevent the fasteners rotating downslope? Is the purlin restraint system adequate to withstand the additional downslope movement/rotation?
- The installers must work from crawling boards to minimise damage to the sheets and to avoid walking on a fragile roof. As fibre cement embrittles with age, existing roofs will be more vulnerable to damage from foot traffic and when working on the roof.
- There should be no foot traffic directly on the sheet surface when cleaning the PV panels. If access onto the roof surface is required, crawling boards or roof ladders should be used.

When considering installing PV with Eternit Profiled Sheeting, please contact the Technical department.

INSULATED SYSTEMS

Built up systems using either a fibre cement or metal lining tray, together with a quilt insulation, have commonly been used in conjunction with fibre cement sheeting.

In more recent years, rigid insulation boards sometimes supported in a T bar grid, have also been used. There are other methods of insulating a roof that may be more appropriate for the design of the roof structure and the required thermal performance.

Please contact Eternit for further advice.

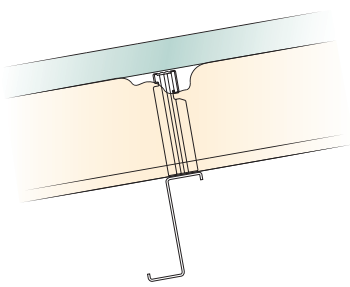
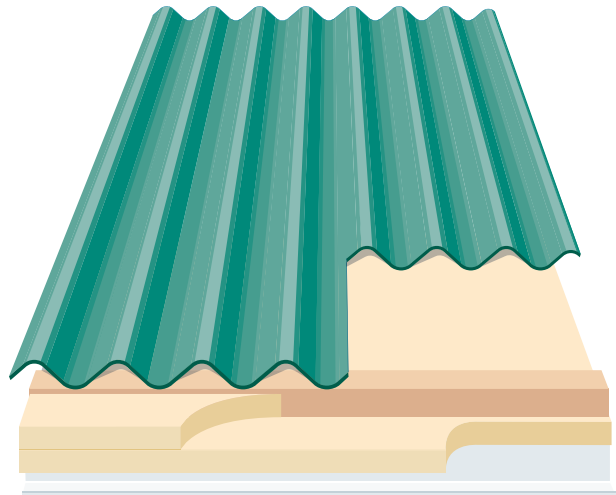

Fig.1 - Steel liner, spacer bar system, quilt insulation

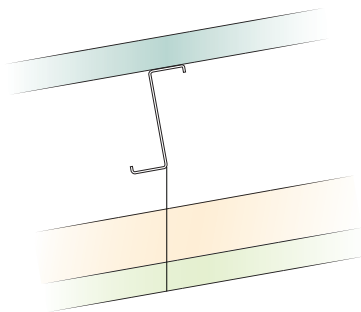

Fig.2 - Rigid insulation board suspended in a T bar grid and additional insulation

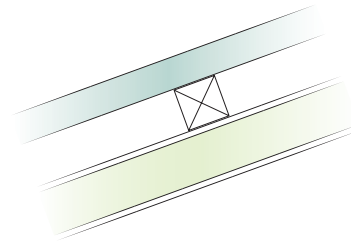

Fig.3 - Sipps panel, timber spacer

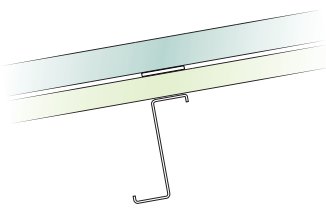

Fig.4 - Rigid insulation board and bearer piece

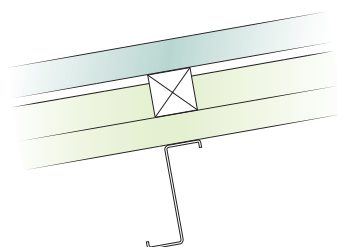

Fig.5 - Rigid insulation board, timber spacer and second insulation layer

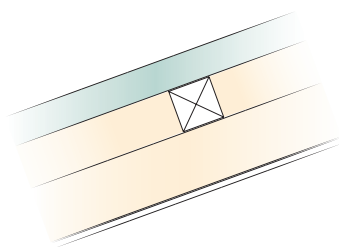

Fig.6 - Insulation between rafters and between purlins

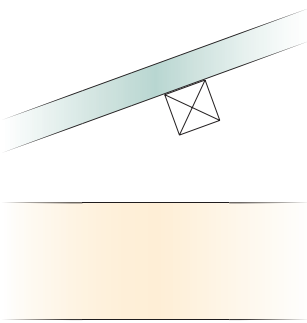
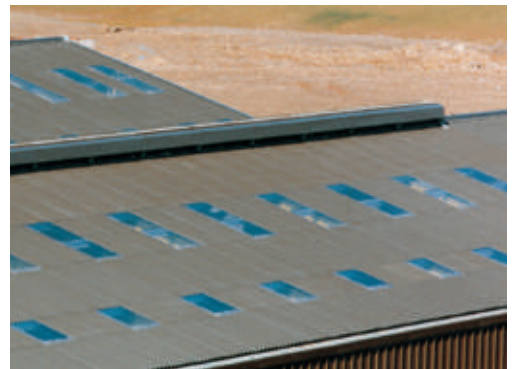

Fig.7 - Insulation at ceiling level

PROFILE 6 VENTILATION

Good ventilation is a critical factor in the design of a building, whether it be new construction or conversion and whether for an agricultural, commercial, industrial or residential application.

Eternit offer four main types of ventilation systems for agricultural buildings, and three for domestic and commercial applications. These are designed to meet most ventilation requirements.



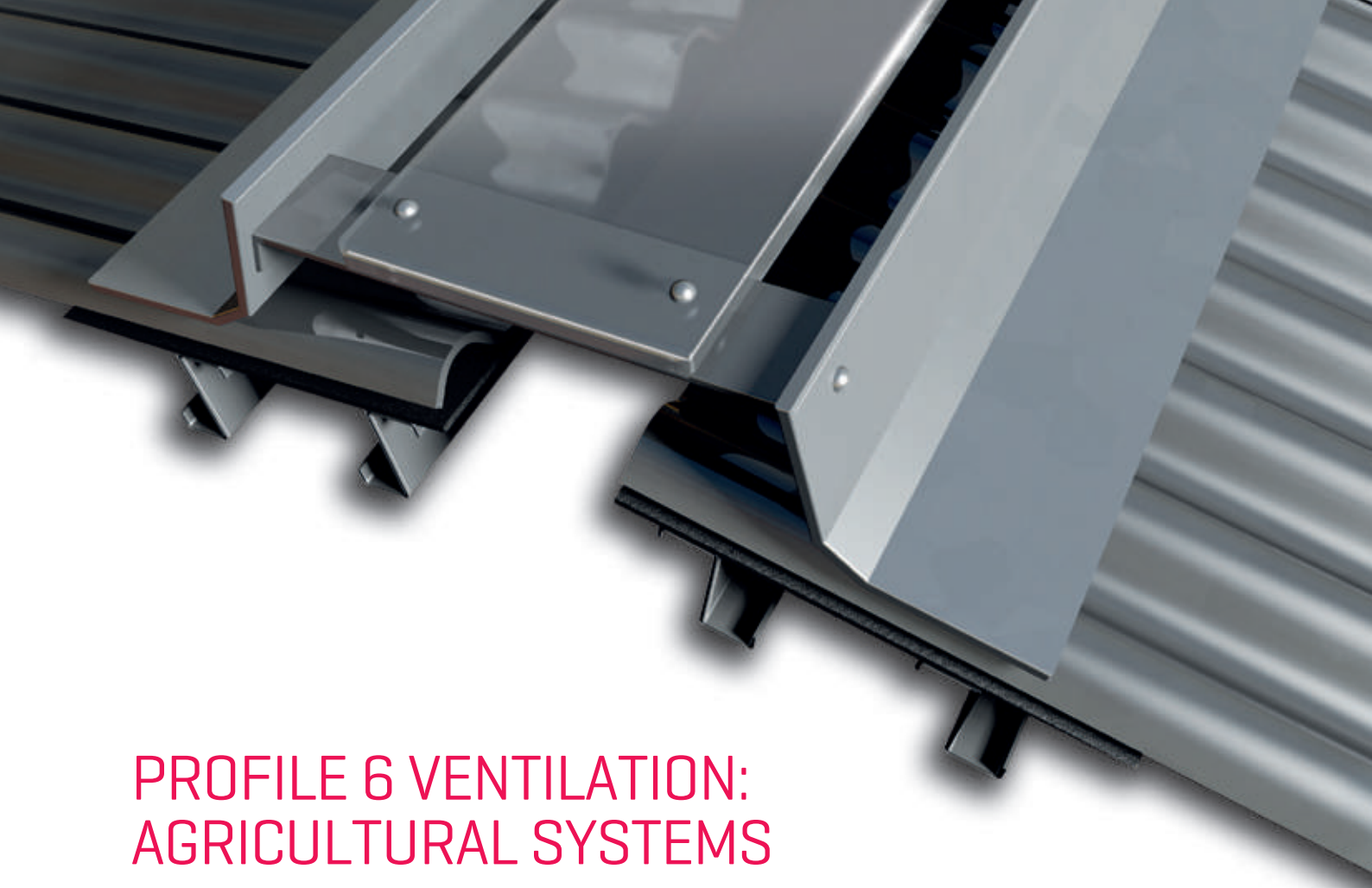

PROFILE 6 VENTILATION: AGRICULTURAL SYSTEMS

* Please note that agricultural ventilation systems are generally used on roof pitches of 15° and above.

System 1: Open ridges

There are two types of open ridge: unprotected and protected. Both provide efficient ventilation whilst simultaneously reducing draughts.

Rain falling into the ridge area will be drained away above the profiled sheeting. It is, however, important to protect the supporting rafters from the elements with a flashing.

Advantages of open ridges

- Provides an efficient outflow of air
- Designed to fit any roof design, but particularly suitable for spaced roofing
- Allows rain to be channelled away over the roof

The critical factor for open ridge ventilation is the air gap marked 'y' on the diagrams below. The clear width of this air gap relates to the number of animals that will be kept inside the building. Eternit recommend that professional advice be sought during construction in order to establish the optimum air space.

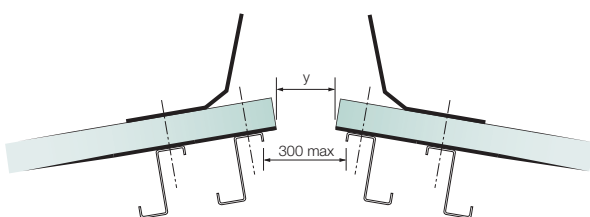

Fig. 1 Unprotected open ridge

To meet the requirements of HSG 33, the gap between the purlins at the apex of the roof should be no more than 300mm. For this reason we show two purlins on each side of the apex. The ventilation gap [y] is therefore limited to 250mm.

Unprotected open ridges [Fig.1]

Ideal for farm buildings with central cleaning passages. Eternit's open ridge fittings are suitable for roofs with pitches from 10° to 22 1/2°.

Protected open ridges [Fig.2]

In this ventilation system, the ridge units should be installed in the same fashion as for unprotected open ridges. Additionally, however, the ridge unit is bridged at 750mm centres by galvanised metal straps manufactured to suit the pitch of the roof. The straps are fixed at an angle of 5° from the horizontal, semi-compressed flat sheeting is then bolted to the straps along the length of the ridge to form a cover.

This cover must be positioned 20mm minimum below the top of the upstands of the ridge units and the total gap between the cover and the open ridge [x] is such that $x = y/2$

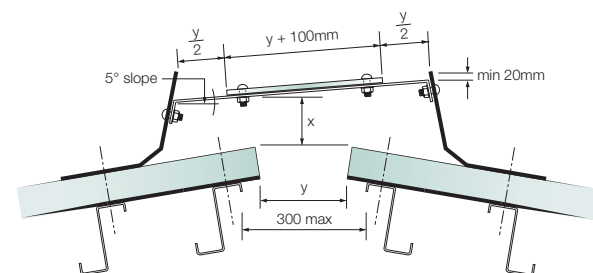
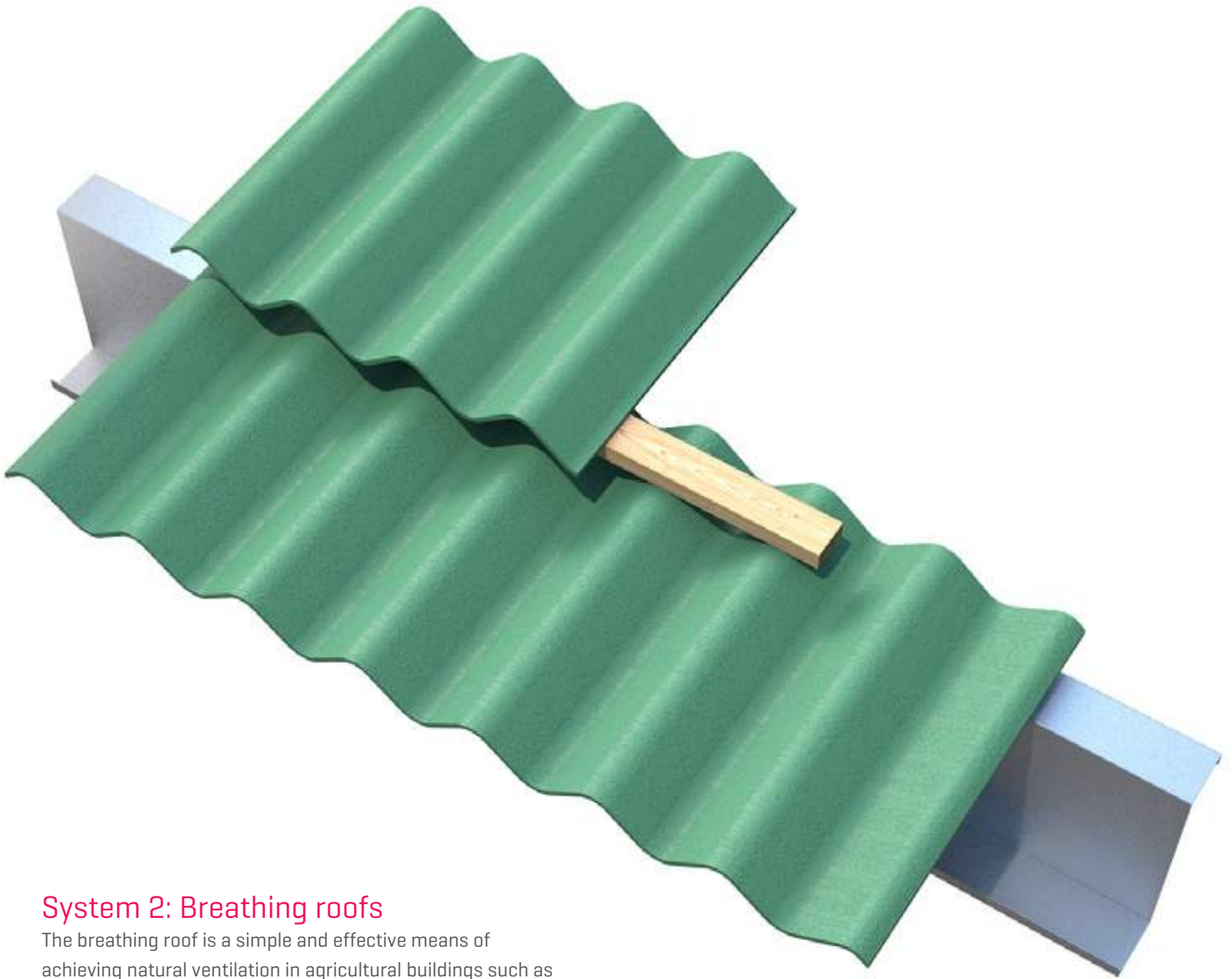

Fig. 2 Protected open ridge



System 2: Breathing roofs

The breathing roof is a simple and effective means of achieving natural ventilation in agricultural buildings such as cattle sheds or pig pens by inserting battens between courses of profiled sheeting.

Advantages of breathing roofs

- Reduction of condensation over the whole roof area
- Small ventilation openings minimise weather penetration
- Eliminates mitring

Breathing roofs with battens [Fig.3]

This form of ventilated roof is achieved simply by inserting a preservative treated 50 x 25mm timber batten between the profiled sheets at the horizontal overlap of each course.

When installing a breathing roof or converting an existing roof, purlins should be fixed at 1375mm maximum centres, with one Profile 6 sheet spanning each purlin spacing. Sheet lengths should be calculated to give a minimum end lap of 150mm. In exposed conditions, this should be increased to 300mm to minimise the penetration of driving rain or snow into the building.

Free air area 46,000mm²/m run.

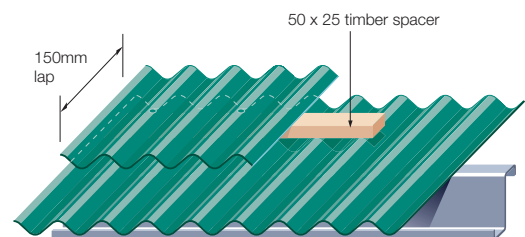

Fig.3 Breathing roofs with battens

PROFILE 6 VENTILATION: AGRICULTURAL SYSTEMS

* Please note that agricultural ventilation systems are generally used on roof pitches of 15° and above.

System 3: Spaced roofs*

In larger span agricultural buildings and those used for high unit intensive rearing, considerable ventilation is required and can be achieved by the use of spaced roofing.

Advantages of spaced roofs

- Achieve a high degree of ventilation and natural internal light
- Minimises internal condensation levels
- Reduction or elimination of mitring

A spaced roof is best achieved by using Profile 6 roof sheets specially trimmed to a width of 1,000mm.

When these sheets are laid with a gap between each vertical run of sheets it provides the maximum ventilation for a building whilst minimising the potential for weather ingress.

Alternate tiers of sheets should, ideally, be turned around so that they are laid with large rolls adjacent to each other.

Trimmed sheets should be fixed with the fastener passing through the crown of the first corrugation in from the edge of the sheet and with two fixings per sheet per purlin.

The gap 'X' (see Fig. 4) will be determined by the size of the building, the amount of ventilation required and the stock units to be housed. The gap, however, should be between 15 and 25mm, to minimise snow bridging and reduce the risk of rain penetration.

Note: A soaker or DPM should be installed beneath each gap in the roof sheeting to protect the purlins, especially where these are timber.

The benefits of using trimmed sheets in this way is that the sheets can be installed the right way up and have well formed edge 'gutters' to prevent water dripping into the building during periods of heavy rainfall. Side laps are not required in installation and the building will receive natural daylight through the openings created. Should rooflights be required in a spaced roof, please contact the Eternit Technical department.

* Please note that sheets fixed in this manner will be classed as a fragile roof covering.

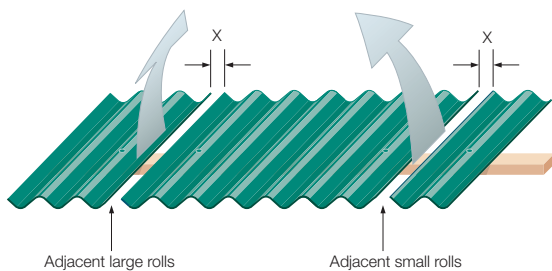

Fig.4 Spaced roof

System 4: Ventilating ridge pieces

Eternit offers two types of prefabricated ridge fitting. These are designed to permit the natural ventilation of buildings where rain penetration during extreme conditions is not detrimental. These ventilating ridge pieces are both fully compatible with all other Eternit Profile 6 sheets and accessories.

The two types of ventilating ridge available are:

- ventilating cranked crown ridge: free air area 68,360mm² (Fig.5)
- two piece ventilating ridge: free air area 33,670mm² per pair (Fig.6)

Advantages of ventilating ridges

- Compatible with other Eternit Profile 6 sheeting products
- Ideal for new and refurbishment projects
- Easy to install

Fixing of ventilating ridges

Before laying either type of ventilating ridge, ensure that the sheets on both slopes are aligned correctly to accept the ventilating ridge pieces.

The ridge purlins should be positioned so that the fixings penetrate not less than 100mm from the end of the ridge.

The underlapping corrugations of the ventilating cranked crown ridge pieces should be mitred, as detailed on page 32. However, the two piece ventilating ridge does not require mitring [see details of two piece ridges on page 51.]

When using ventilating ridge units, always use a standard ridge unit at each end of the ridge and at movement joints.

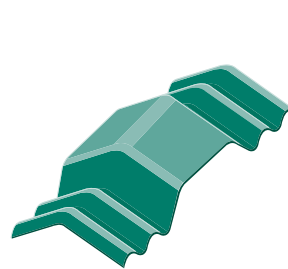

Fig.5 Ventilating cranked crown ridge piece

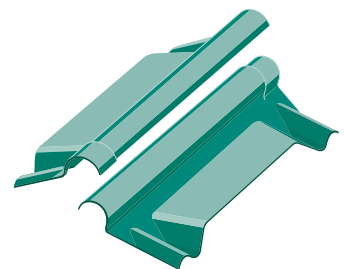

Fig.6 Two piece ventilating ridge piece





Andal Magna
Community Primary School



HEALTH, SAFETY & SITEWORK

Storage and working	74
Site preparation and safety	75

STORAGE & WORKING

Storage

General

Profiled sheets should be stored as close as practically possible to the area of works, on a firm level base, using the profiled bearers [on which the sheets are delivered] to raise the sheets off the ground. Sheeting stacks should generally not exceed 1200mm high unless a level concrete base is available, in which case the maximum height is 1500mm. A separate stack should be made of each length of sheet; if this is not possible, stack with longest sheets at the bottom and the shortest at the top. It is important when stacking Profile 6 sheets on site that the smaller 'under rolls' are all on the same side of the stack. Sheets should always be stored weather [smooth] side upwards.

Stacks of sheets should not be stored in full sun during the summer months as the differential temperature across the sheets can result in unacceptable stresses in the sheets and can lead to edge cracking.

If sheets are to be retained in the packs for more than three months, they should be stored inside a building where they can be protected from extreme variations in temperature and moisture.

Ingress of moisture into packs of profiled sheets may cause efflorescence staining, bowing during installation or permanent distortion.

When handling sheets, lift by the ends only.

Natural Grey sheets

The plastic wrapping should be retained for as long as possible to control the environment around the sheets. Once the pack has been opened, or if the wrapping is damaged and allowing the ingress of water, the sheets should be stored under cover.

Coloured sheets

Coloured sheets should be stored under cover at all times, preferably inside a building, but if this is not available they can be stored under a tarpaulin. The tarpaulin should be spaced off the top and sides of the sheets to allow effective air circulation and avoid condensation.

The plastic wrapping on coloured sheets is only designed to protect the sheets in transit. It should be removed and carefully disposed of as soon as possible.

Working

When cutting fibre cement sheets, try to eliminate the exposure to dust [refer to Eternit Health and Safety data sheet].

Preferably sheets should be cut at ground level on suitable rigid supports using hand or powered saws. Powered saws should be of the reciprocating saw type and NOT disc or circular blade devices. Experience has shown that hand or powered saw blades having 3-3.5mm tooth pitch are most suited.

An approved P3 respirator must be worn to prevent the inhalation of dust when other measures fail to adequately control the dust produced during the mechanical machining of products.

Notes: When roofing buildings where there will be higher than normal temperatures (e.g. buildings housing foundries or kilns), cement based sheets should be stored near a heat source prior to fixing, and be fixed on a dry day. Consideration should be given to providing additional movement joints over areas that are subject to sudden changes in temperature.

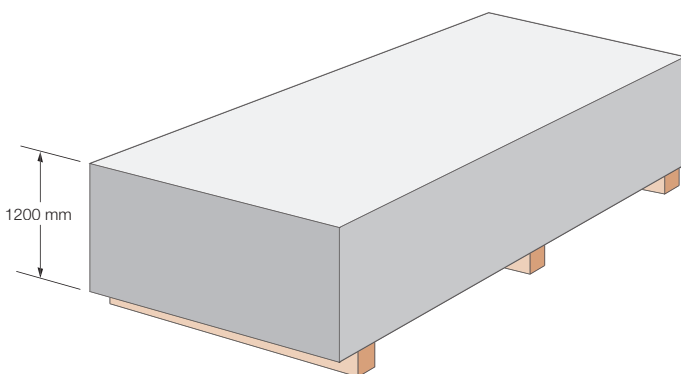

SITE PREPARATION & SAFETY

Preparation

Prior to sheeting, a responsible person should check that all purlins and rails are connected securely. Measurements should be taken to ensure that the structure and purlins are true and level to receive the sheeting. In particular, a check should be made that the purlins are spaced correctly for the right end lap, and that the eaves purlin provides an overhang into the gutter not exceeding 350mm [Profile 6] and 250mm [Profile 3]. When the sheeting layout is being planned, care should be taken to ensure that the verge sheets are cut so that the outside edge coincides with a crown rather than a trough in the corrugations. This enhances the weather protection and can reduce the width of the flashings.

CDM Regulations

Specifiers have an obligation under the Construction (Design and Management) Regulations 2015 to identify and evaluate the health and safety implications of all products and construction methods required by their design.

Installation

The following guidelines should always be observed:

- Sheets should be installed smooth surface up.
- All fixing holes should be drilled, not punched, and adequate clearance (2mm minimum) provided for the fixing shank.
- There should be two fixings per sheet per purlin or fixing rail at the point shown on page 38 [P6] or 42 [P3].
- Always lay the sheets in vertical tiers from the eaves to the ridge.
- Always fix sheets fully before moving on.
- To minimise dust, cut sheets with a handsaw or slow-speed reciprocating power saw. The use of angle grinders is not recommended.
- Avoid deflecting a sheet whilst attempting to force a bearing.
- Do not step on side lap corrugations.
- Where regular access is required to reach roof lights, ventilation and service ducts, properly constructed walkways should be provided.

Safety at Work

The recommendations of HSG 33 should be followed at all times:

- A safe place of work should be provided. Health and Safety Provisions should comply with current regulations and be suitable for working at height. The use of safety nets as fall arrest equipment should always be considered.
- Profile 6 sheets, when new and first installed in accordance with our recommendations, can be classified as a non-fragile Class C roof assembly in accordance with ACR[M]001. Once the roof has been completed and the netting/scaffolding removed, if any subsequent access is required on the roof, the sheets should be treated as a fragile assembly.
- Always use HSE recommended roof access systems whenever required.

Always observe the relevant provisions of the Health and Safety at Work Act, and any other safety legislation currently in force.





SERVICES & SUPPORT

Resources	78
Services	78
Sustainability and Standards	79



RESOURCES

tools and assets that make design and specification as straightforward as possible

Fixing instructions

Comprehensive sitework, fixing and installation literature:
eternit.co.uk

Literature

All current product and technical literature can be downloaded:
eternit.co.uk

CPDs

Understand our recommendations relating to British Standards and Codes of Practice: eternit.co.uk

Samples

Profiled sheeting samples are available for all of the colours featured in this brochure and available to order from: eternit.co.uk

Stockist information

To find details for stockists of Eternit products, visit: eternit.co.uk

CAD details

Access to CAD drawings can be obtained by emailing techuk@eternit.co.uk



SERVICES

Getting our knowledge to you and your project smoothly and efficiently

Customer services

Eternit is committed to providing outstanding customer care and is staffed by experienced personnel:

E-mail infouk@etexgroup.com

To find your nearest stockist, please visit: eternit.co.uk

Technical Advisory Team

Specifiers require prompt, knowledgeable and detailed responses to a vast range of enquiries covering everything from sheet information to the different ventilation options available.

Our Technical Advisory Team is staffed by a qualified team with specialist knowledge not only of all Eternit products, but also crucially, how those systems integrate with other roofing components and comply with Building Regulations, Health and Safety, environmental and other critical roofing criteria.

E-mail techuk@eternit.co.uk

eternit.co.uk



SUSTAINABILITY & STANDARDS

Credits, credentials and clarity of information

Quality standard

The Eternit UK factory is ISO 9001, 14001 and ISO OHSAS 18001 accredited. It achieves the highest standards in quality, health and safety and the environment.

CE Marking

All of our products covered by an EN Standard carry an appropriate CE Mark. This means that our products meet the required safety standards and have a guaranteed level of quality..

BREEAM and the Code for Sustainable Homes

Credits gained from specifying our A-rated products, combined with additional credits from BES 6001 make our products more beneficial to the specifier.

This publication is based on the latest data available at the time of printing. Due to product changes, improvements and other factors, the Company reserves the right to change or withdraw information contained herein without prior notice. For specific applications users should refer to the Technical Advisory Team and relevant Standards and Codes of Practice for guidance. The photography shown in the document should not necessarily be taken as recommendations of good practice. The printing process restricts the exact representation of colours. For true colour reference, please request product samples.



Telephone 01283 501555
Email infouk@etexgroup.com
Or visit eternit.co.uk

Etex [Exteriors] UK, Wellington Road, Burton-upon-Trent, Staffordshire DE14 2AP