

MiGo Link

SR 940f



en	Installation instructions	3
en	Figures.....	10

Installation instructions

1 Safety

1.1 Intended use

In the event of inappropriate or improper use, damage to the product and other property may arise.

The product is used to control your heating installation. The Wi-Fi gateway is connected to your router via WLAN, and establishes an Internet connection for the heating installation.

Intended use includes the following:

- observance of accompanying operating, installation and maintenance instructions for the product and any other system components
- installing and setting up the product in accordance with the product and system approval
- compliance with all inspection and maintenance conditions listed in the instructions.

Intended use also covers installation in accordance with the IP rating.

This product can be used by children aged from 8 years and persons with reduced physical, sensory or mental capabilities or lack of experience and knowledge if they have been

given supervision or instruction concerning use of the product in a safe way and understand the hazards involved. Children must not play with the product. Cleaning and user maintenance work must not be carried out by children unless they are supervised.

Using the product with a power supply unit cable other than the one supplied or the connection cable for connecting directly to the heat generator is considered to be improper use.

Any other use that is not specified in these instructions, or use beyond that specified in this document, shall be considered improper use. Any direct commercial or industrial use is also deemed to be improper.

Caution.

Improper use of any kind is prohibited.

1.2 Danger caused by improper operation

Improper operation may present a danger to you and others, and cause material damage.

- ▶ Carefully read the enclosed instructions and all other applicable documents, particularly the "Safety" section and the warnings.

- ▶ As the end user, you should only carry out those activities for which these instructions provide instructions and that are not marked with the  symbol.

1.3 Safety warning – Power supply unit

Condition: The product is installed with the supplied power supply unit.

- ▶ Only use the power supply unit indoors.
- ▶ Do not operate the power supply unit in wet environments or in the rain.
- ▶ If the power supply unit has visible damage or is defective, you must not operate it.
- ▶ Keep the power supply unit, its individual parts and the packaging material away from children.
- ▶ Only connect the power supply unit if the mains voltage for the plug socket matches the information on the data plate.
- ▶ Only connect the power supply unit to an easily accessible plug socket so that you can disconnect the power supply unit quickly from the power grid in the event of a fault.
- ▶ The power supply unit heats up during operation. Do not

- cover the power supply unit with objects, and ensure that it is sufficiently ventilated.
- ▶ The outer connection cable on the power supply unit cannot be replaced. If the connection cable becomes damaged, the entire power supply unit must be scrapped.

1.4 -- Safety/regulations

Note the following information when work is required on the heat generator's electronics box:

1.4.1 Risk of death from electric shock

There is a risk of death from electric shock if you touch live components.

Before commencing work on the product:

- ▶ Unplug the mains plug.
- ▶ Or disconnect the product from the power supply by switching off all power supplies (electrical partition with a contact gap of at least 3 mm, e.g. fuse or circuit breaker).
- ▶ Secure against being switched back on again.
- ▶ Wait for at least 3 minutes until the capacitors have discharged.
- ▶ Check that there is no voltage.



1.4.2 Risk of material damage caused by frost

- ▶ Do not install the product in rooms prone to frost.

1.4.3 Risk of material damage caused by using an unsuitable tool

- ▶ Use the correct tool.

1.4.4 Regulations (directives, laws, standards)

- ▶ Observe the national regulations, standards, directives, ordinances and laws.

2 Notes on the documentation

2.1 Observing other applicable documents

- ▶ You must observe all the operating and installation instructions included with the system components.
- ▶ Observe the country-specific notes in the Country Specifics appendix.

2.2 Storing documents

- ▶ Pass these instructions and all other applicable documents on to the end user.

2.3 Validity of the instructions

These instructions apply only to:

Product	Article number	Gateway part numbers
SR 940f	0010038368	0020292013

3 Product description

3.1 CE marking



The CE marking shows that the products comply with the basic requirements of the applicable directives as stated on the declaration of conformity.

The manufacturer hereby declares that the type of radio equipment that is described in these instructions complies with Directive 2014/53/EU. The complete text for the EU Declaration of Conformity is available at: <http://www.vaillant-group.com/doc/doc-radio-equipment-directive/>.

3.2 Recycling and disposal



■ If the product is identified with this symbol, it does not belong with the household waste at the end of its useful life.

- ▶ Instead, take the product to a collection point for recycling waste electrical or electronic equipment.

For more information on where to take waste electrical and electronic equipment, contact your town or district authorities or your waste recycling centre.

3.3 Symbols on the data plate

Symbol	Meaning
	Protection class III

3.4 Symbols on the data plate for the power supply unit

Symbol	Meaning
	Protection class II
	Use only in interior rooms
	Polarity of the extra-low voltage plug

4 Installing and setting up an Internet connection

4.1 Checking the assembly and installation prerequisites

- ▶ Check:
 - WLAN signal available
 - Routing and security parameters in the IP network: Ports 80, 123 and 443 enabled for outgoing connections
 - Dynamic IP addressing (**DHCP**) available
 - The installation site and cabling for the Wi-Fi gateway with the heat generator is not publicly accessible
 - Internet connection for permanent Internet communication is available

- WLAN router has an activated fire-wall
- WLAN network is encrypted, see technical data
- eBUS line accessible, if required
- Free plug socket available, if required

4.2 Observing the installation steps

1. Observe the installation steps in the illustrated instructions at the end of this document.
2. Ensure that all additional system components, such as the control, are operating when you switch on the Wi-Fi gateway.

Condition: You want to connect the product to the Internet.

- ▶ Press and hold the button beside the LED for three to ten seconds.
 - ◀ The product is now in coupling mode for 15 minutes.
- ▶ For additional instructions, follow the MiGo Link app.

Condition: You want to connect the product to a compatible radio room thermostat.

- ▶ Briefly press the button beside the LED once.
 - ◀ The product is now in coupling mode for 3 minutes.
- ▶ Within the next three minutes, press the system button for the room thermostat that is located within range.

4.3 Meaning of the LEDs

LED	Status	Meaning
Green	Flashing	The product starts.
Blue	Flashing rapidly	The product is in WLAN coupling mode.
Blue	Lights up	The product is connected to the Internet and is ready for operation.

LED	Status	Meaning
Green	Lights up	The product is ready for operation but is not connected to the Internet.
Blue	Flashing	Product software is updating.
Orange	Slowly flashing	The product is in room thermostat coupling mode.
Red	Lights up	Internet connection has been disconnected/fault.
Purple	Flashing three times	The product is identified via the Apple Home app.

4.4 Background information

For further information on the product and the system, you can call up the following website:

- www.migolink.com

You can only use the product's scope of functions with the MiGo Link app. To install the app, you must accept the T&Cs and Privacy Policy.

If you connect the product to the Internet without using the MiGo Link app, the product automatically sends the following technical data to the manufacturer's server:

- Data about the product (serial number, unit type, unit ID, etc.)
- Data about the firmware (firmware version, update status, etc.)
- Data about the network (IP address, MAC address, etc.)

This data is used only for the provision of required firmware updates. You can find detailed information about the data processing in the Privacy Policy:

- privacy.migolink.com

An Internet connection is a prerequisite for connecting the product with several smart home solutions from third-party providers. You can find a list of the partners at:

– privacy.migolink.com

Scan the QR code in order to call up the website directly.



When using the product with smart home solutions from third-party providers, the third-party provider's T&Cs and Privacy Policy also apply with regard to the collection and processing of their data. The product manufacturer has no influence on this and assumes no liability for this.

Additional information about using the product with Apple devices:

Communication between iPhone, iPad, Apple Watch, HomePod, HomePod mini, or Mac and the HomeKit-enabled MiGo Link is secured by HomeKit technology.

Use of the Works with Apple badge means that an accessory has been designed to work specifically with the technology identified in the badge and has been certified by the developer to meet Apple performance standards. Apple is not responsible for the operation of this device or its compliance with safety and regulatory standards.

Apple, Apple Home, Apple Watch, HomeKit, HomePod, HomePod mini, iPad, iPad Air, iPhone, and tvOS are trademarks of Apple Inc., registered in the U.S. and other countries and regions.

4.5 Requesting licences

This product contains free and open-source software. The corresponding licence information is saved on the Wi-Fi gateway and can be displayed using the MiGo Link app.

You can request the source code, for a processing fee, from the following address: opensource@migolink.com

This offer applies for three years from the date of purchase, or at least for the time

in which we offer support for the Wi-Fi gateway.

5 Repair

5.1 Replacing the connection cable

- ▶ If you replace the connection cable, only use an original connection cable from the manufacturer (article number 0020299966 or 0020299967).

5.2 Replacing the power supply unit

- ▶ If you replace the power supply unit, only use the original power supply unit from the manufacturer (article number 0020292010 or 0020292011).

6 Decommissioning

1. Deactivate the product in the MiGo Link app.
2. Reset the product to its factory settings by pressing and holding the button next to the LED for at least 10 seconds.
 - ◀ The LED goes out as soon as the resetting process starts.
 - ◀ Your information and settings are deleted.
 - ◀ The connection to the coupled radio room thermostat is deleted.
3. Decommission the product.

7 Customer service

The contact details for our customer service are provided on the back page, in the appendix or on our website.

No software is perfect and, for that reason, we are always working on additional improvements for you. If you find indications of a weak spot or of a safety issue, please notify us by sending a message to:

secure@migolink.com

8 Product data in accordance with EU Ordinance no. 811/2013, 812/2013

Depending on the system configuration, this product can work as a weather-compensated control with room temperature modulation and therefore contains the correction factor for control technology class VI. A deviation from the seasonal room-heating efficiency is possible depending on the system configuration.

Temperature control class	VI
Contribution to the seasonal room-heating energy efficiency η_s	4.0 %

9 Technical data

Technical data – Wi-Fi gateway

Rated voltage	5 to 24 V ---
Requirement for the power supply *	ES1 or PS1 in accordance with IEC 62368-1
Average power consumption	3 W
Radio frequency bands	868.0–868.6 MHz, 869.4–869.65 MHz
WLAN radio frequency band	2.4 GHz
Radio frequency output at 868.0–868.6 MHz (max. e.r.p.)	6.6 dBm
Radio frequency output at 869.4–869.65 MHz (max. e.r.p.)	6.9 dBm
WLAN radio frequency output (max. e.r.p.)	17.5 dBm
WLAN channels	1 – 13
WLAN encryption	WPA2-PSK, WPA3 personal
IP assignment	DHCP
Maximum environmental temperature	50 °C

Extra low-voltage wire (bus line) – cross-section	$\geq 0.75 \text{ mm}^2$
Height	96 mm
Width	122 mm
Depth	36 mm
IP rating	IP 21
Protection class	III
Permitted degree of environmental pollution	2



Note

* Applies for use with the connection cable for the direct connection to the heat generator.

Technical data – Plug-in power supply unit

Rated voltage	120 to 230 V _{AC}
Rated current	0.3 A
Output AC voltage	5 V
Max. output direct current	1 A
Mains frequency	50/60 Hz
IP rating	IP 20
Protection class	II
Permitted degree of environmental pollution	2

Figures

1 Installation

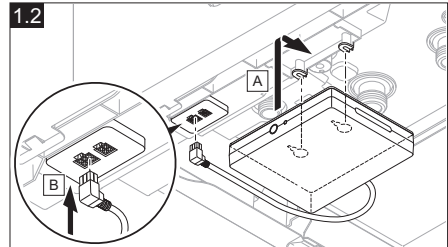
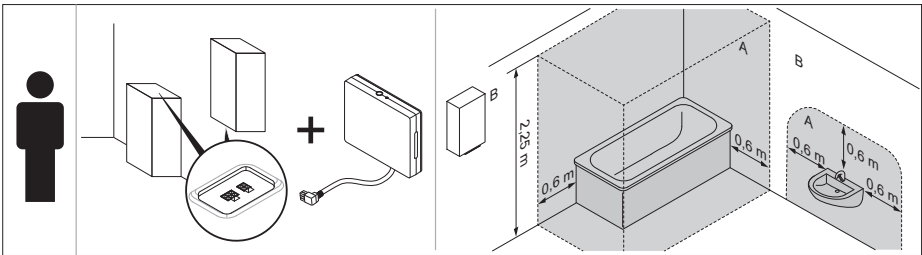
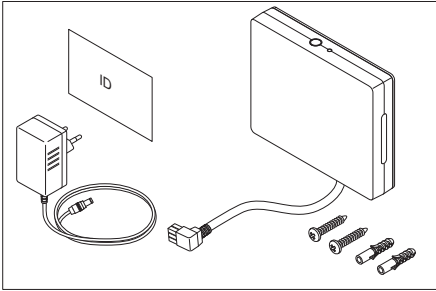

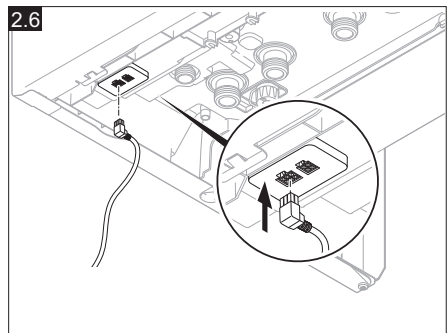
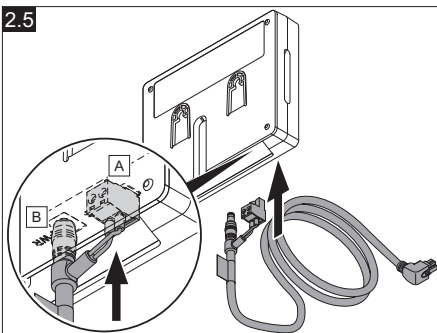
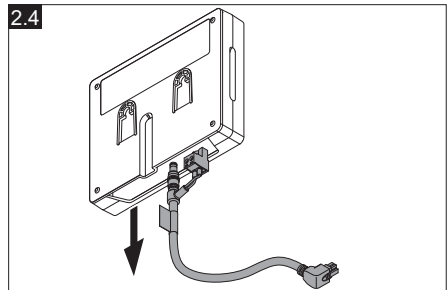
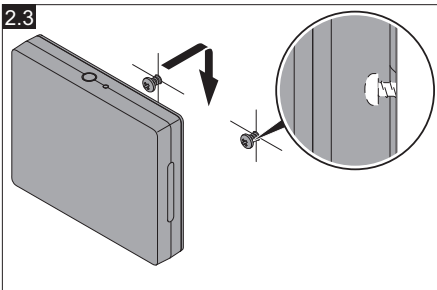
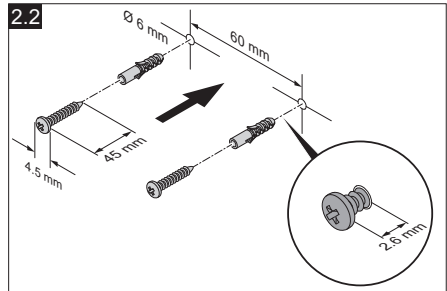
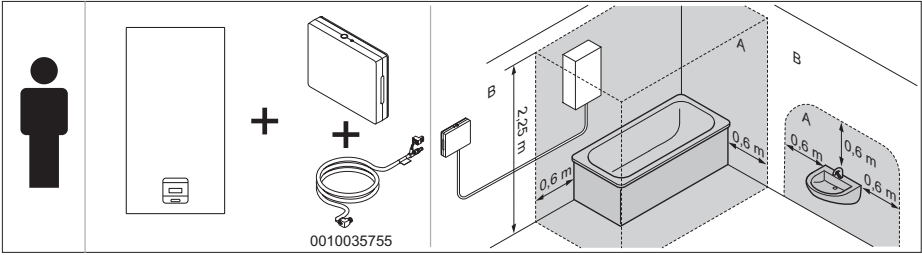

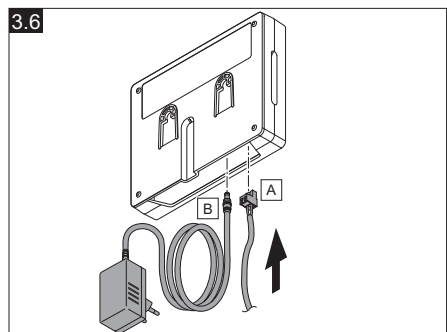
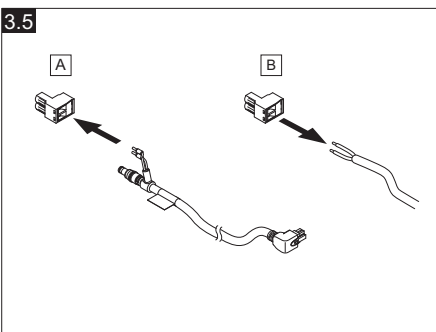
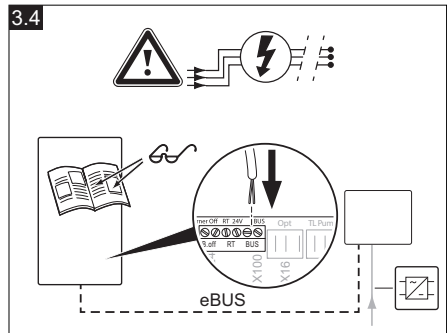
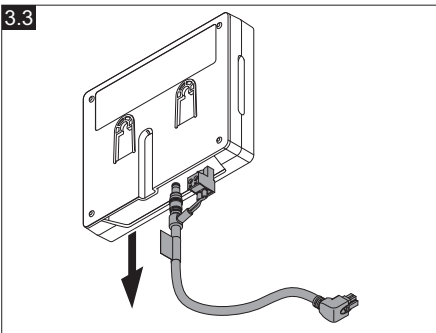
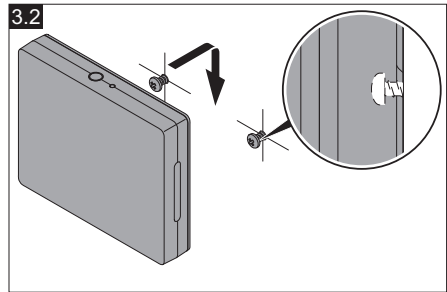
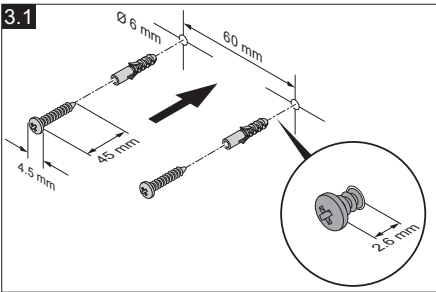
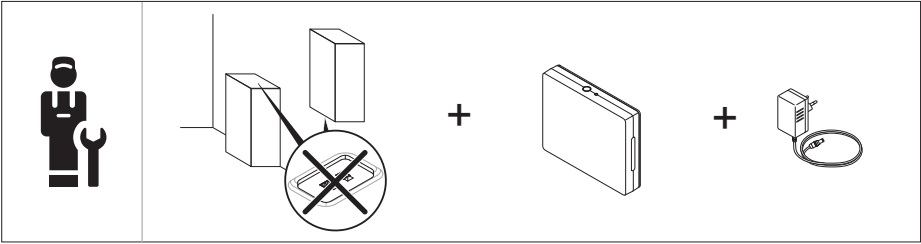

3.7

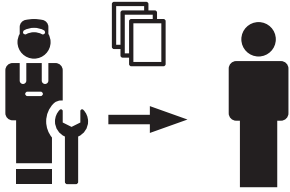

3.8

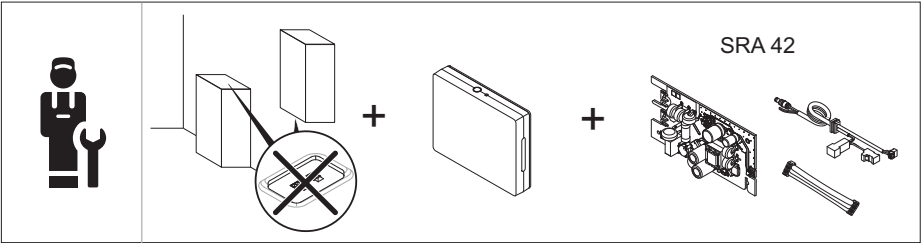

4.1



4.2

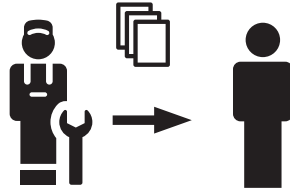

4.3



Supplier**Vaillant Group UK LTD**

Nottingham Road ■ Belper-Derbyshire ■ DE56 1JQ

Telephone 01773 824639 ■ Technical helpline 0330 100 7679

After sales service 0330 100 3142

www.glow-worm.co.uk



0020328021_02

Publisher/manufactureur**SDECCI SAS**

17, rue de la Petite Baratte ■ 44300 Nantes

Téléphone +33 24068 1010 ■ Fax +33 24068 1053

© These instructions, or parts thereof, are protected by copyright and may be reproduced or distributed only with the manufacturer's written consent.

Subject to technical modifications.