

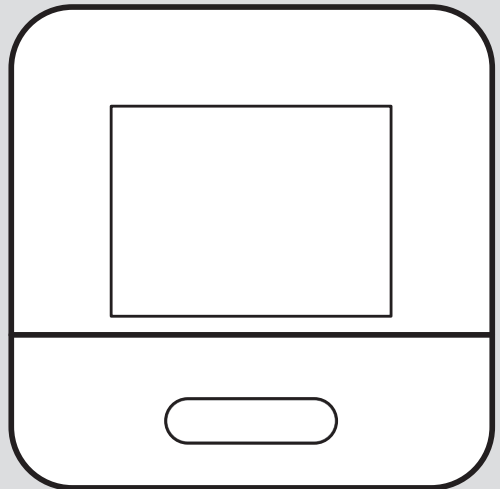



MiSet

SRT 380/2



Operating and installation instructions

Contents

1	Safety	3
1.1	Intended use	3
1.2	General safety information.....	3
1.3	 -- Safety/regulations	4
2	Product description	5
2.1	Which nomenclature is used?.....	5
2.2	What is the effect of the frost protection function?	5
2.3	What do the following temperatures mean?.....	5
2.4	What is a zone?	5
2.5	What is the circulation?.....	5
2.6	What is meant by "time period"?	5
2.7	Preventing malfunctions	6
2.8	Setting the heat curve.....	6
2.9	Display, control elements and symbols.....	6
2.10	Operating and display functions	8
3	 -- Electrical installation, set-up	15
3.1	Selecting the lines.....	15
3.2	Installing the system control	16
4	 -- Start-up	18
4.1	Prerequisites for starting up.....	18
4.2	Running the installation assistants.....	18
4.3	Changing the settings later.....	18
5	Fault and maintenance messages	18
5.1	Fault message	18
5.2	Maintenance message.....	18
6	Information about the product	18
6.1	Observing and storing other applicable documents	18
6.2	Validity of the instructions.....	18
6.3	Data plate	18
6.4	Serial number	19
6.5	CE marking	19
6.6	Guarantee and customer service	19
6.7	Recycling and disposal	19
6.8	Product data in accordance with EU Ordinance no. 811/2013, 812/2013.....	19
6.9	Technical data – System control	20
Appendix		21
A	Troubleshooting, maintenance message	21
A.1	Troubleshooting	21
A.2	Maintenance messages.....	22
B	 -- Troubleshooting, maintenance message	22
B.1	Troubleshooting	22
B.2	Troubleshooting	23
B.3	Maintenance messages.....	23
Index		24

1 Safety

1.1 Intended use

In the event of inappropriate or improper use, damage to the product and other property may arise.

The product is intended for using an eBUS interface to control a heating installation with heat generators from the same manufacturer.

The room temperature control controls based on the installed system:

- Heating
- Domestic hot water generation
- Circulation

Intended use includes the following:

- observance of accompanying operating, installation and maintenance instructions for the product and any other system components
- installing and setting up the product in accordance with the product and system approval
- compliance with all inspection and maintenance conditions listed in the instructions.

Intended use also covers installation in accordance with the IP code.

This product can be used by children aged from 8 years and above and persons with reduced physical, sensory or mental capabilities or lack of experience and knowledge if they have been given supervision or instruction concerning use of the product in a safe way and understand the hazards involved. Children must not play with the product. Cleaning and user maintenance work must not be carried out by children unless they are supervised.

Any other use that is not specified in these instructions, or use beyond that specified in this document, shall be considered improper use. Any direct commercial or industrial use is also deemed to be improper.

Caution.

Improper use of any kind is prohibited.

1.2 General safety information

1.2.1 Risk caused by inadequate qualifications

The following work must only be carried out by competent persons who are sufficiently qualified to do so:

- Set-up
- Dismantling



- Installation
- Start-up
- Decommissioning
- ▶ Proceed in accordance with current technology.

Work and functions that must only be carried out or set by the competent person are marked by the  symbol.

1.2.2 Danger caused by improper operation

Improper operation may present a danger to you and others, and cause material damage.

- ▶ Carefully read the enclosed instructions and all other applicable documents, particularly the "Safety" section and the warnings.
- ▶ As the end user, you should only carry out those activities for which these instructions provide instructions and that are not marked with the  symbol.

1.3 -- Safety/regulations

1.3.1 Risk of material damage caused by frost

- ▶ Do not install the product in rooms prone to frost.

1.3.2 Regulations (directives, laws, standards)

- ▶ Observe the national regulations, standards, directives, ordinances and laws.



2 Product description

2.1 Which nomenclature is used?

- System control: Instead of **SRT 380/2**
- Remote control: Instead of **SR 92** and **SR 92/2**

2.2 What is the effect of the frost protection function?

The frost protection function protects the heating installation and flat from frost damage.

At outdoor temperatures

- Below 4 °C for longer than four hours, the system control switches the heat generator on and regulates the target room temperature to at least 5 °C.
- Above 4 °C, the system control does not switch the heat generator on, but it monitors the outdoor temperature.

2.3 What do the following temperatures mean?

Desired temp. is the temperature to which you want to heat up the living rooms.

Set-back temp. is the level below which the temperature in the living rooms does not fall when outside of the time periods.

Flow temp. is the temperature at which the heating water leaves the heat generator.

2.4 What is a zone?

A building can be divided into multiple areas, which are known as zones. A different requirement can be placed on the heating installation in each zone.

Examples for dividing into zones:

- Underfloor heating (zone 1) and a radiator system (zone 2) are available in one building.
- A building is made up of several self-contained residential units. Each residential unit has its own zone.

2.5 What is the circulation?

An additional water pipe is connected to the domestic hot water pipe and forms a circuit with the domestic hot water cylinder. A circulation pump facilitates the continuous circulation of domestic hot water through the pipework system which means that hot water is immediately available, even at more distant draw-off points.

2.6 What is meant by "time period"?

Example of heating mode in the mode: Time-controlled

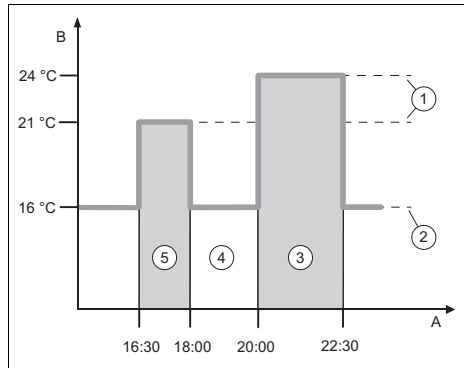

A	Time	3	Time period 2
B	Temperature	4	Outside of the time periods
1	Desired temperature	5	Time period 1
2	Set-back temperature		

You can divide a day up into several time periods (**3**) and (**5**). Each time period can comprise an individual start time and end time. The time periods must not overlap. You can assign a different desired temperature (**1**) to each time period.

Example:

16:30 to 18:00; 21 °C

20:00 to 22:30; 24 °C

The system control regulates the living rooms to the desired temperature within the time periods. In the times outside of the time periods (**4**), the system control

regulates the living rooms to the lower set-back temperature (2) that is set.

2.7 Preventing malfunctions

- ▶ Do not cover the system control with furniture, curtains or other objects.
- ▶ If the system control is installed in the living room, open all of the thermostatic radiator valves in this room fully.

2.8 Setting the heat curve

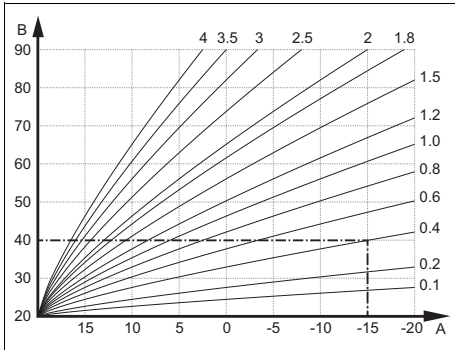

A Outside temperature °C B Target flow temperature °C

The figure shows the possible heat curves of 0.1 to 4.0 for a target room temperature of 20 °C. If, for example, heat curve 0.4 is selected, a flow temperature of 40 °C is maintained at an outdoor temperature of -15 °C.

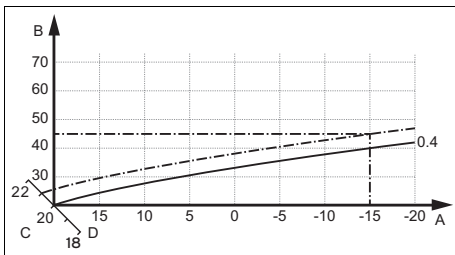

A Outdoor temperature °C C Target room temperature °C
B Target flow temperature °C D Axis a

If the heat curve 0.4 is selected and 21 °C is specified for the target room temperature, the heat curve is then translated, as

shown in the figure. The heat curve is displaced according to the value of the target room temperature along axis a which is angled at 45°. At an outdoor temperature of -15 °C, the control system provides a flow temperature of 45 °C.

2.9 Display, control elements and symbols

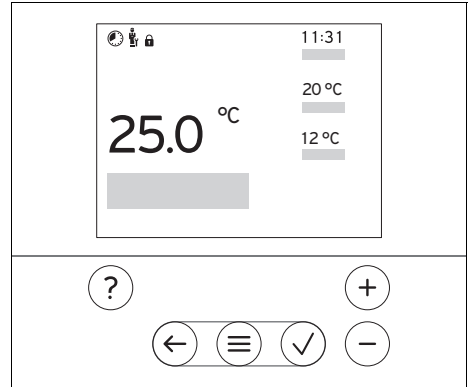

2.9.1 Control elements

- ☰ – Calling up the menu
- ← – Back to the main menu
- ✓ – Confirming a selection/change
- ✓ – Saving set values
- ← – One level back
- ← – Cancelling input
- +
- and – Navigating through the menu structure
- – Reducing or increasing the set value
- – Navigating to individual numbers/letters
- ?
- Calling up help
- Calling up the time programme assistant

Active control elements light up red.

Press ☰ once: You access the basic display.

Press ☰ twice: You access the menu.

2.9.2 Symbols



Time-controlled heating active



Button lock active



Maintenance required



Fault in the heating installation



Contact the competent person

2.10 Operating and display functions



Note

The functions described in this section are not available for all system configurations.

To call up the menu, press  twice.

2.10.1 CONTROL menu item

MENU → CONTROL		
→ Zone		
→ Mode:	→ Manual	→ Desired temperature: °C
	Uninterrupted retention of the desired temperature	
	→ Time-contr.	→ Weekly planner
	→ Set-back temperature: °C	
	Weekly planner: Up to 12 time periods and desired temperatures can be set per day The competent person sets how the heating installation behaves outside of the time period in the Set-back mode: function. In Set-back mode: means: <ul style="list-style-type: none"> – Eco: The heating is switched off outside of the time periods. Frost protection is activated. – Normal: The set-back temperature applies outside of the time periods. 	
	Desired temperature: °C: Applies within the time periods Factory setting: Set-back temperature: °C 15 °C	
	→ Off	
Heating is switched off, domestic hot water continues to be available, frost protection is activated		
→ Name of zone	Changing the name Zone 1 , which was set at the factory	
→ Absence	→ All: Applies only to any zones within the specified time period	
	→ Zone: Applies for the selected zone in the specified time period	
	During this time, heating mode runs at the defined set-back temperature. Domestic hot water mode and circulation are switched off. Factory setting: Set-back temperature: °C 15 °C	
→ DHW		
→ Mode:	→ Manual	→ DHW temperature: °C
	Uninterrupted retention of the domestic hot water temperature	
	→ Time-contr.	→ Domestic hot water weekly planner
	→ DHW temperature: °C	
	→ Circulation weekly planner	

MENU → CONTROL	
→ Mode:	<p>Domestic hot water weekly planner: Up to three time periods can be set per day</p> <p>DHW temperature: °C: Applies within the time periods</p> <p>Domestic hot water mode is switched off outside of the time periods</p> <p>Circulation weekly planner: Up to three time periods can be set per day</p> <p>The circulation pump pumps hot water to the draw-off points within the time periods</p> <p>Outside of the time periods, the circulation pump is switched off</p>
	→ Off
	Domestic hot water mode is switched off
→ Hot water boost	Heating up the water in the cylinder once
→ Ventilation boost	Heating mode is switched off for 30 minutes.
→ Time programme assistant	<p>Programming of the desired temperature for Monday–Friday and Saturday–Sunday; the programming applies for the time-controlled Heating, DHW and Circulation functions.</p> <p>Overwrites the weekly planner for the Heating, DHW and Circulation functions.</p>
→ Installation off	Installation is switched off. Frost protection remains active.

2.10.2 INFORMATION menu item

MENU → INFORMATION	
→ Current temperatures	
→ Zone	
→ DHW temperature	
→ Water pressure: bar	
→ Energy data	
→ Power consumption	→ Heating
	→ DHW
	→ Installation
→ Fuel consumption	→ Heating
	→ DHW
	→ Installation

MENU → INFORMATION

Energy consumption display

In the display and in the app that can also be used, the control displays values for the energy consumption.

The control displays an estimation of the values for the installation. Among other things, the values are influenced by the following:

- The installation/design of the heating installation
- User behaviour
- Seasonal environmental conditions
- Tolerances and components

External components, such as external heating pumps or valves, and other consumers and appliances in the household are still not taken into consideration.

The deviations between the energy consumption that is displayed and the actual energy consumption may be significant.

The specifications for the energy consumption are not suitable to be used to create or compare energy billing.

The following can be read: **Current month, Last month, Current year, Last year, Total**

→ **Burner status:**

→ Control elements	Explanation of the control elements
---------------------------	-------------------------------------

→ Menu introduction	Explanation of the menu structure
----------------------------	-----------------------------------

→ **Competent person contact info**

→ **Serial number**

2.10.3 SETTINGS menu item

MENU → SETTINGS



→ **Installer level**

→ Enter access code	Access to the installer level, factory setting: 00
→ Competent person contact info	Entering contact details
→ Service date:	Enter the next service date for a connected component, e.g. heat generator
→ Fault history	Faults are listed in chronological order
→ Installation configuration	Functions (→ Installation configuration menu item)
→ Screed drying	Activate the Screed drying profile function for freshly laid screed in accordance with the construction regulations. The system control regulates the flow temperature independently of the outdoor temperature. Setting screed drying (→ Installation configuration menu item)

→ **Change code**

→ **Language, time, display**

→ **Language:**

→ Date:	After the power is switched off, the date is retained for approx. 30 minutes.
----------------	---

MENU → SETTINGS

→ Time:	After the power is switched off, the time is retained for approx. 30 minutes.
→ Display brightness:	Brightness during active use.
→ Dimmed displ. brightness:	Brightness in standby.
→ Daylight saving time:	→ Automatic
	→ Manual
The change takes place:	
<ul style="list-style-type: none"> – On the last weekend in March at 02:00 (daylight saving time) – On the last weekend in October at 03:00 (standard time) 	
→ Offset	
→ Room temperature: K	Comparison of the temperature difference between the measured value in the system control and the value for a reference thermometer in the living room.
→ Outdoor temperature: K	Comparison of the temperature difference between the measured value in the outdoor temperature sensor and the value for a reference thermometer in the living room.
→ Factory settings	The system control resets all of the settings to the factory settings and calls up the installation assistant. Only the competent person can call up the installation assistant.

**2.10.4 Installation configuration menu item****MENU → SETTINGS → Installer level → Installation configuration**→ **Installation**

→ Water pressure: bar	
→ eBUS components	List of eBUS components and their software versions
→ Adaptive heat curve:	Automatic fine adjustment of the heat curve. Prerequisite: <ul style="list-style-type: none"> – The suitable heat curve for the building is set in the Heat curve: function. – The correct zone is assigned to the system control or the remote control in the Zone assignment: function. – Expanded is selected in the Room temp. mod.: function.
→ Control:	R.temp.contr It is controlled via the room temperature.
	Weath.-comp. It is controlled via the outdoor temperature as soon as an outdoor temperature sensor is connected.
→ OT constant heating: °C	If the outdoor temperature falls below the set temperature value, the Heat curve: is used to regulate to a room temperature of 20 °C outside of the time periods. OT ≤ set temperature value: No night set-back or total shut-down Factory setting: Off

MENU → SETTINGS → Installer level → Installation configuration		
→ Desired preheating temp.:	This is where you can select the desired pre-heating time temperature in order to activate the heating before the heating programme first starts. The aim is to reach the room temperature at the desired time. The system automatically calculates the required prerun time (max. 4 hrs) based on prior experience, the current room temperature and the time remaining until the programme changes. Factory setting: Off	
→ Heat generator 1		
→ Status:		
→ Current flow temperature: °C		
→ Circuit 1		
→ Status:		
→ Target flow temperature: °C		
→ OT switch-off threshold: °C	Enter the upper limit for the outdoor temperature. If the outdoor temperature rises above the set value, the system control deactivates heating mode.	
→ Heat curve:	The heat curve (→ section "Product description") is the dependence of the flow temperature on the outdoor temperature for the desired temperature (target room temperature).	
→ Min. target flow temperature: °C	Enter the lower limit for the target flow temperature. The system control compares the set value with the calculated target flow temperature, and regulates to the larger of these values.	
→ Max. target flow temperature: °C	Enter the upper limit for the target flow temperature. The system control compares the set value with the calculated target flow temperature, and regulates to the smaller of these values.	
→ Set-back mode:		
	→ Eco	The heating function is switched off and the frost protection function is activated. At outdoor temperatures that are below 4 °C for longer than four hours, the system control switches the heat generator on and regulates to the Set-back temperature: °C . At an outdoor temperature above 4 °C, the system control switches the heat generator off. The monitoring of the outdoor temperature remains active. Heating circuit behaviour outside of the time periods. Prerequisite: <ul style="list-style-type: none"> – Time-contr. is activated in the Heating → Mode: function. – Active or Inactive is activated in the Room temp. mod.: function. If Expanded is activated in the Room temp. mod. , the system control regulates to the target room temperature 5 °C independently of the outdoor temperature.
	→ Normal	The heating function is switched on. The system control regulates to the Set-back temperature: °C . Prerequisite: Time-contr. is activated in the Heating → Mode: function.

MENU → SETTINGS → Installer level → Installation configuration

The behaviour can be adjusted separately for each heating circuit.

→ **Room temp. mod.:**

	→ Inactive	
	→ Active	Adjusting the flow temperature based on the current room temperature.
	→ Expanded	Adjusting the flow temperature based on the current room temperature. The system control also activates/deactivates the zone. <ul style="list-style-type: none"> – The zone is deactivated: Current room temperature + 2/16 K > set room temperature – Zone is activated: Current room temperature < set room temperature - 3/16 K

The installed temperature sensor measures the current room temperature. The system control calculates a new target room temperature that is used to adjust the flow temperature.

- Difference = Set target room temperature - current room temperature
- New target room temperature = Set target room temperature + difference

Prerequisite: In the **Zone assignment:** function, the system control and/or the remote control is assigned to the zone in which the system control or remote control is installed.

The **Room temp. mod.:** function is ineffective if **No assignmt** is activated in the **Zone assignment:** function.

→ **Zone**

→ Zone activated:	Deactivate zones that are not required. All existing zones appear in the display.
→ Zone assignment:	Assign the system control and/or remote control to the selected zone. The system control and/or remote control must be installed in the selected zone. The control system also uses the room temperature sensor for the assigned unit. The remote control uses all of the values for the assigned zone. If no zone has been assigned to the system control and/or the remote control, the Room temp. mod.: function is ineffective.
→ Zone valve status:	

→ **DHW**

→ Cylinder:	If there is an existing domestic hot water cylinder, the Active setting must be selected.
→ Target flow temperature: °C	
→ Circulation pump:	
→ Anti-legio. day:	Define the days on which you want the anti-legionella function to run. On these days, the water temperature is increased to above 60 °C. The circulation pump is activated. The function ends after 120 minutes at the latest. If the Absence function is activated, the anti-legionella function is not carried out. As soon as the Absence function ends, the anti-legionella function is carried out.
→ Anti-legio. time:	Define the time at which you want the anti-legionella function to run.
→ Cylinder charging hysteresis: K	The cylinder charging starts as soon as cylinder temperature < desired temperature - hysteresis value.

MENU → SETTINGS → Installer level → Installation configuration	
→ Cylinder charging offset: K	Desired temperature + offset = flow temperature for the domestic hot water cylinder.
→ Max. cyl. charging time:	Setting the maximum time at which the domestic hot water cylinder can be charged without interruption. If the maximum time or the target temperature is reached, the system control enables the heating function. The Off setting means that the cylinder charging time is not restricted.
→ Cyl. charg. anti-cycl. time: min	Setting the time period during which the cylinder charging is blocked after the maximum cylinder charging time has elapsed. During the blocked time, the system control enables the heating function.
→ Screed drying profile	Setting target flow temperature per day in accordance with the construction regulations

3 -- Electrical installation, set-up

Only qualified electricians may carry out the electrical installation.

The heating installation must be decommissioned before work is carried out on it.

3.1 Selecting the lines

Line cross-section

eBUS line (fine-wire, flexible, made of copper)	0.75 to 1.5 mm ²
eBUS line (single-wire, made of copper)	1.0 to 1.5 mm ²
Sensor cable (fine-wire, flexible, made of copper)	0.75 to 1.5 mm ²
Sensor cable (single-wire, made of copper)	1.0 to 1.5 mm ²

Line length

Sensor lines	≤ 50 m
Bus lines	≤ 125 m

3.2 Installing the system control

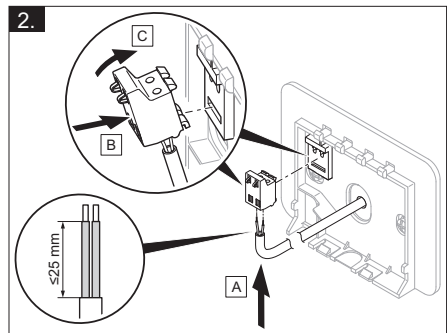
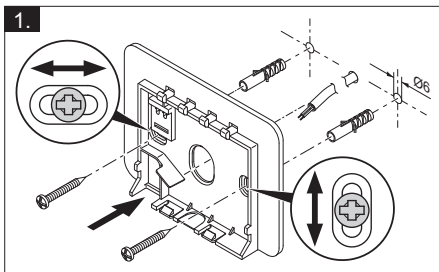
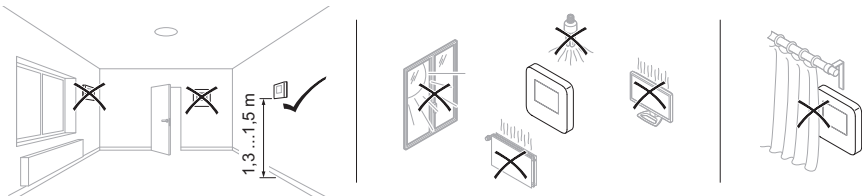
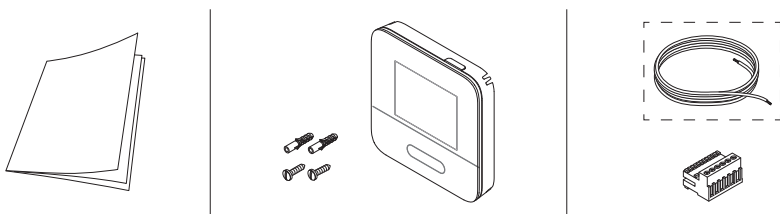

3.

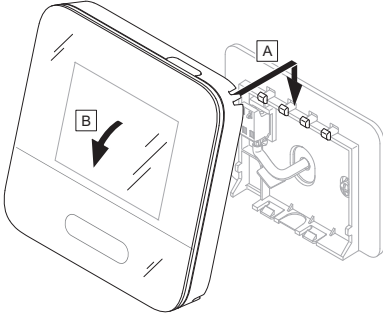

4 -- Start-up

4.1 Prerequisites for starting up

- The system control and, if required, the outdoor temperature sensor have been electrically installed and wired.
- Start-up of all system components (except for the system control) is complete.

4.2 Running the installation assistants

The installation assistant is at the **Language**: query.

The system control's installation assistant takes you through a list of functions. For each function, you should choose the set value that is best suited to the heating installation being installed.

4.2.1 Completing the installation assistant

Once you have gone through the installation assistant, **Select the next step**. appears on the display

Installation configuration: The installation assistant switches to the system configuration for the installer level, in which you can further optimise the heating installation.

Installation start: The installation assistant switches to the basic display and the heating installation works with the values you have set.

4.3 Changing the settings later

All settings that you have made via the installation assistant can be changed again at a later date via the end user or installer level.

5 Fault and maintenance messages

5.1 Fault message

 with the text of the fault message appears in the display.

You can find fault messages under: **MENU** → **SETTINGS** → **Installer level** → **Fault history**

Troubleshooting (→ Appendix)

5.2 Maintenance message

 with the text of the maintenance message appears in the display.

Maintenance message (→ Appendix)

6 Information about the product

6.1 Observing and storing other applicable documents

- ▶ Observe all of the instructions that are intended for you and are enclosed with the components of the installation.
- ▶ As the end user, keep these instructions and all other applicable documents safe for future use.

6.2 Validity of the instructions

These instructions apply only to:

- 0020260999

6.3 Data plate

The data plate is located on the rear of the product.

Information on the data plate	Meaning
Serial number	for identification; 7th to 16th digits = product article number
MiSet	Product designation

Information on the data plate	Meaning
V	Rated voltage
mA	Rated current
	Read the instructions

6.4 Serial number

You can call up the serial numbers under **MENU** → **INFORMATION** → **Serial number**. The 10-digit article number is located in the second line.

6.5 CE marking



The CE marking shows that the products comply with the basic requirements of the applicable directives as stated on the declaration of conformity.

The declaration of conformity can be viewed at the manufacturer's site.

6.6 Guarantee and customer service

6.6.1 Guarantee

For information on the manufacturer's guarantee, you can write to the contact address that is provided on the back page or by visiting <https://self-service.glow-worm.co.uk/warranty-registration/step-one/>.

6.6.2 Customer service

For contact details for our customer service department, you can write to the address that is provided on the back page, or you can visit www.glow-worm.co.uk.

6.7 Recycling and disposal

- ▶ The competent person who installed your product is responsible for the disposal of the packaging.



■ If the product is labelled with this mark:

- ▶ In this case, do not dispose of the product with the household waste.
- ▶ Instead, hand in the product to a collection centre for waste electrical or electronic equipment.



■ If the product contains batteries that are labelled with this mark, these batteries may contain substances that are hazardous to human health and the environment.

- ▶ In this case, dispose of the batteries at a collection point for batteries.



– Packaging

- ▶ Dispose of the packaging correctly.
- ▶ Observe all relevant regulations.

6.8 Product data in accordance with EU Ordinance no. 811/2013, 812/2013

On units with integrated weather-compensated controls, including a room thermostat function that can be activated, the seasonal room-heating efficiency always includes the correction factor for control technology class VI. The seasonal room-heating efficiency may deviate if this function is deactivated.

Temperature control class	V
Contribution to the seasonal room-heating energy efficiency η_s	3.0 %







6.9 Technical data – System control

Rated voltage	9 to 24 V ---
Rated surge voltage	330 V
Pollution degree	2
Rated current	< 50 mA
Supply line cross-section	0.75 to 1.5 mm ²
IP rating	IP 20
Protection class	III
Temperature for the ball pressure test	75 °C
Maximum permitted environmental temperature	0 to 60 °C
Current room air hum.	35 to 95 %
Mode of operation	Type 1
Height	122 mm
Width	122 mm
Depth	26 mm

Appendix

A Troubleshooting, maintenance message

A.1 Troubleshooting

Symptom	Possible cause	Measure
Display remains dark	Software error	<ol style="list-style-type: none"> 1. Press and hold the button on the top right of the system control for longer than five seconds in order to force a restart. 2. Switch off the mains switch on all heat generators for approx. 1 minute and then switch them on again. 3. If the fault message persists, inform the competent person.
No changes in the display can be made via the control elements	Software error	<ol style="list-style-type: none"> 1. Press and hold the button on the top right of the system control for longer than five seconds in order to force a restart. 2. Switch off the mains switch on all heat generators for approx. 1 minute and then switch them on again. 3. If the fault message persists, inform the competent person.
Display: Button lock activated , it is not possible to change the settings or values	Button lock is active	<ul style="list-style-type: none"> ▶ Press the button on the top right of the system control for approx one second in order to deactivate the button lock.
Display: F. Boiler fault , the specific fault code (e.g. F.33) with the specific boiler is shown in the display	Boiler fault	<ol style="list-style-type: none"> 1. Reset the boiler by first selecting Reset and then Yes. 2. If the fault message persists, inform the competent person.
Display: You do not understand the set language	Incorrect language set	<ol style="list-style-type: none"> 1. Press  twice. 2. Select the last menu item  SETTINGS and confirm by pressing . 3. Under  SETTINGS, select the second menu item and confirm by pressing . 4. Select the language that you understand and confirm by pressing .

A.2 Maintenance messages

#	Code/meaning	Description	Maintenance work	Interval	
1	Water deficiency: Follow the instructions in the heat gen.	The water pressure is too low in the heating installation.	Refer to the operating instructions for the relevant heat generator for information on filling with water	See the operating instructions for the heat generator	



B -- Troubleshooting, maintenance message

B.1 Troubleshooting

Symptom	Possible cause	Measure
Display remains dark	Software error	<ol style="list-style-type: none"> 1. Press and hold the button on the top right of the system control for longer than five seconds in order to force a restart. 2. Switch the mains switch on the heat generator that feeds the system control off and back on again.
	No power supply on the heat generator	▶ Re-establish the power supply to the heat generator; this is the same power supply that feeds the system control.
	The product is defective	▶ Replace the product.
No changes in the display can be made via the control elements	Software error	▶ Switch the mains switch on the heat generator that feeds the system control off and back on again.
	The product is defective	▶ Replace the product.
Heat generator continues to heat once the room temperature has been reached	Incorrect value in the Room temp. mod.: or Zone assignment: function	<ol style="list-style-type: none"> 1. In the Room temp. mod.: function, set the value Active or Expanded. 2. In the zone in which the system control is installed, assign the system control's address in the Zone assignment: function.
The heating installation remains in domestic hot water mode	Heat generator cannot reach the max. target flow temperature	▶ Reduce the set value in the Max. target flow temperature:°C function.
It is not possible to switch to the installer level	You do not know the code for the installer level	▶ Reset the system control to the factory setting. All set values will be lost.

B.2 Troubleshooting

Code/meaning	Possible cause	Measure
Outdoor temperature sensor signal invalid	Outdoor temperature sensor defective	▶ Replace the outdoor temperature sensor.
Heat generator 1 communication interrupted	The cable is defective	▶ Replace the cable.
	Incorrect plug connection	▶ Check the plug connection.
Remote control 1 missing	Missing remote control	▶ Connect the remote control.
Room temp. sensor signal on control invalid	Room temperature sensor defective	▶ Replace the control.
Room temp. sensor signal on remote control 1 invalid	Room temperature sensor defective	▶ Replace the remote control.
Assignment of remote control 1 missing	The assignment of remote control 1 to the zone is missing.	▶ Assign the correct address to the remote control in the Zone assignment: function.
Zone activation missing	A zone that is in use is not yet activated.	▶ In the Zone activated: function, select the value Yes .

B.3 Maintenance messages

#	Code/meaning	Description	Maintenance work	Interval	
1	Heat generator 1 requires maintenance	The heat generator requires maintenance work.	Refer to the operating or installation instructions for the relevant heat generator for information on the maintenance work required	See the operating or installation instructions for the heat generator	
2	Water deficiency: Follow the instructions in the heat gen.	The water pressure is too low in the heating installation.	Water deficiency: Follow the instructions in the heat generator	See the operating or installation instructions for the heat generator	
3	Maintenance Contact:	Date on which maintenance is due for the heating installation.	Carry out the required maintenance work	Date entered in the control	

Index

A

Article number 19

C

CE marking..... 19

Competent person 3

Control elements 6

D

Display..... 6

Disposal..... 19

Documents 18

F

Fault 18

Frost 4

I

Intended use..... 3

L

Lines, maximum length 15

Lines, minimum cross-section 15

Lines, selecting..... 15

M

Maintenance..... 18

O

Operating and display functions 8

P

Prerequisites for starting up the heating
installation 18

Prerequisites, start-up 18

Preventing a malfunction..... 6

Q

Qualification..... 3

R

Reading the article number 19

Reading the serial number 19

Recycling..... 19

Regulations 4

Running the installation assistants 18

S

Serial number 19

Setting the heat curve 6

Supplier

Vaillant Group UK LTD

Nottingham Road ■ Belper-Derbyshire ■ DE56 1JQ

Telephone 01773 824639 ■ Technical helpline 0330 100 7679

After sales service 0330 100 3142

www.glow-worm.co.uk



0020323636_00

Publisher/manufacture

Vaillant Group UK LTD

Nottingham Road ■ Belper-Derbyshire ■ DE56 1JQ

Telephone 01773 824639 ■ Technical helpline 0330 100 7679

After sales service 0330 100 3142

www.glow-worm.co.uk

© These instructions, or parts thereof, are protected by copyright and may be reproduced or distributed only with the manufacturer's written consent.

Subject to technical modifications.