

DOOR PANEL

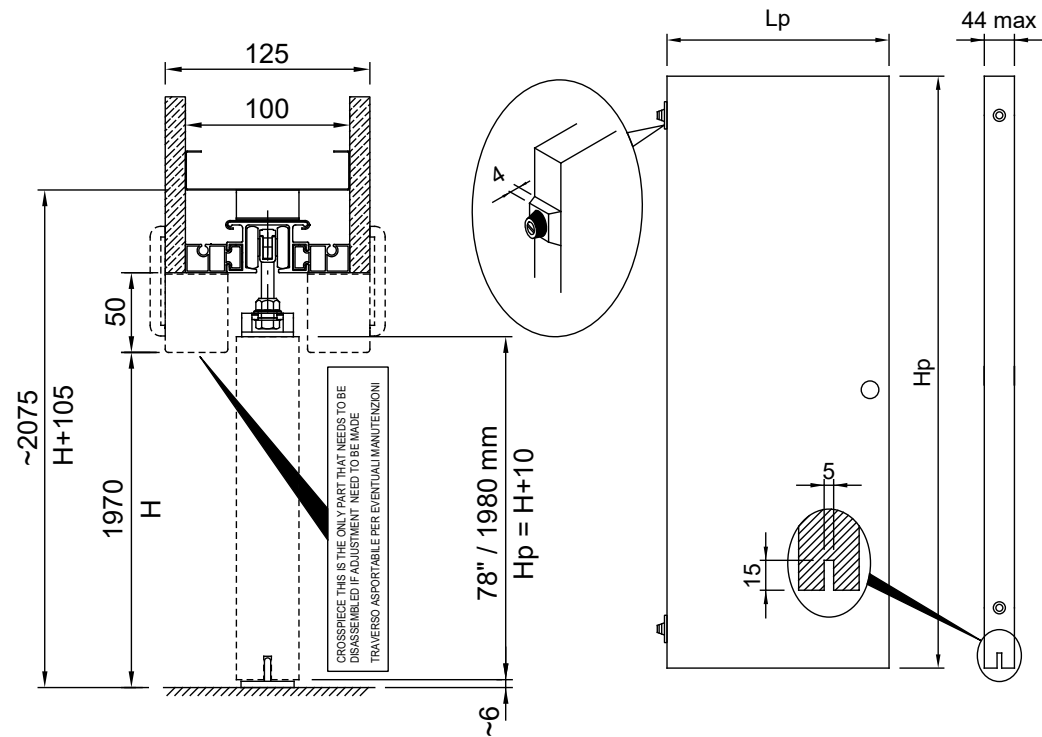

SINGLE DOOR

DOOR SIZE			OPENING SIZE	
Lp	Hp	n°	L	H
in / mm	in / mm		mm	mm
24" / 610	78" / 1980	1	580	1970
27" / 686		1	656	
30" / 762		1	732	
33" / 838		1	808	
36" / 914		1	884	

DOUBLE DOOR

DOOR SIZE			OPENING SIZE	
Lp	Hp	n°	L	H
in / mm	in / mm		mm	mm
24" / 610	78" / 1980	2	1160	1970
27" / 686		2	1312	
30" / 762		2	1464	
33" / 838		2	1616	
36" / 914		2	1768	

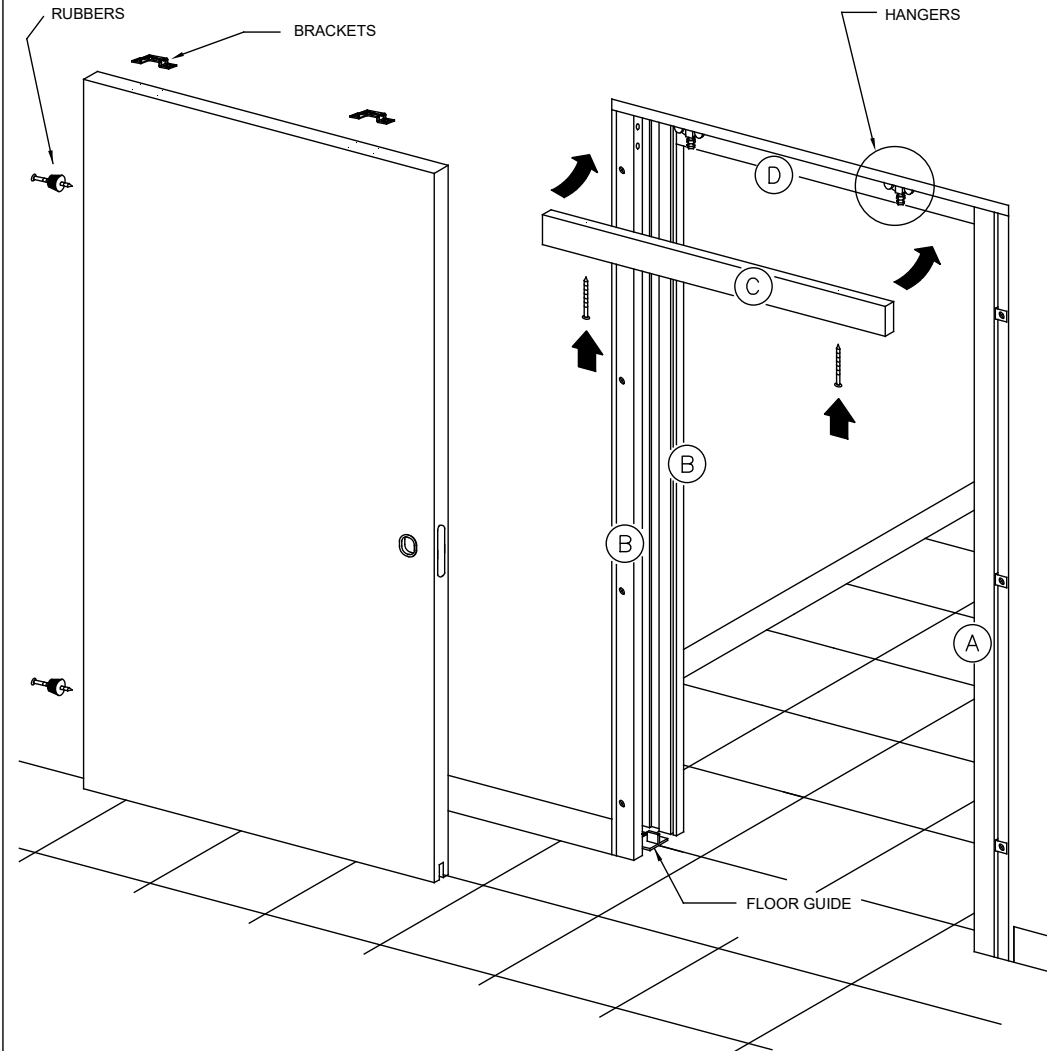
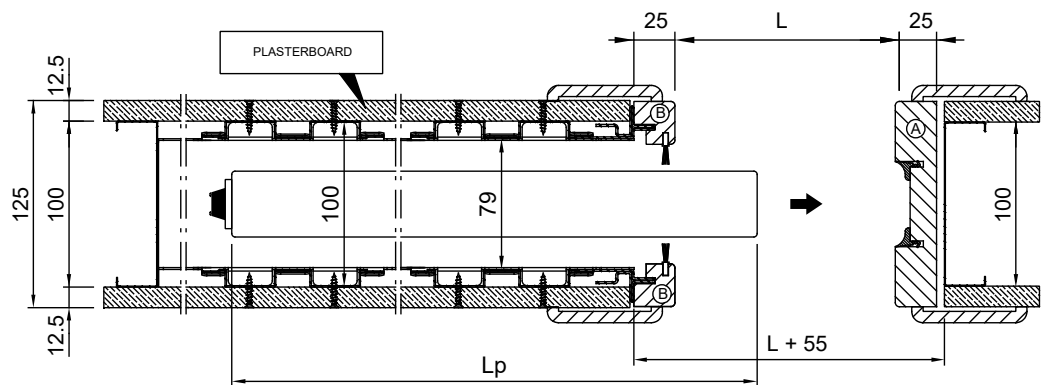

The information given in this document is for descriptive purposes only. SCRIGNO S.p.A. will not be held responsible for any inaccuracies caused by printing errors, transcription errors or for any other reason, and reserves the right to make modifications, without giving prior notice, for the improvement of its products. The reproduction, including the partial reproduction, of this document is severely prohibited within the terms of the Law.



Scigno SpA | scrigno.net
via Casale Sant'Ermete 975
47822 Santarcangelo di Romagna (RN)
ph. + 39 0541 757711
fax + 39 0541 757780
scrigno@scrigno.it

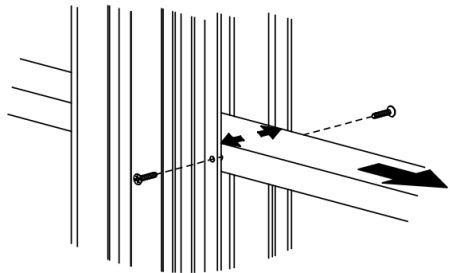

REMOVE THE SCREWS AND THE INSTALLATION SPACER.

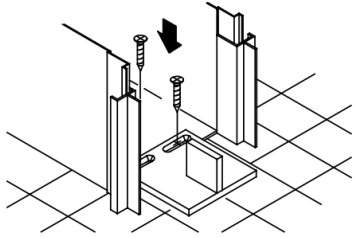

FIX FLOOR GUIDE USING SCREWS 4.2X9.5. IF THE FRAME IS NOT AT THE SAME LEVEL OF THE FLOOR USE THE SUPPLIED SPACER FOR THE FLOOR GUIDE AND IN THIS CASE USE SCREWS 4.2X19.

FIT JAMB "B" ON THE BOX FRAME AS SHOWN. IT IS HELPFUL TO DRILL THE METAL SHEET BEFORE SECURING WITH THE SELF TAPPING SCREWS.

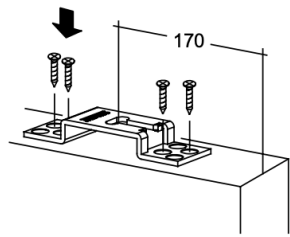
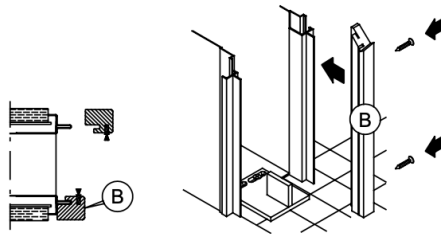

FIX THE BRACKETS, WHICH SUPPORT THE HANGERS, TO THE TOP OF THE DOOR AT 170 mm AS SHOWN IN THE DRAWING WITH 4.5X25 SCREWS. IT IS IMPORTANT THAT THE SLOT FOR HANGER HOOKING IS TOWARDS THE FRONT SIDE OF THE DOOR.

FIT THE RUBBER ON TO A 4 mm THICKNESSES ON THE REAR EDGE OF THE PANEL FOR A TOTAL DISAPPEARANCE OF THE DOOR. FOR A PARTIAL DISAPPEARANCE OF THE DOOR, FIX A TIMBER SPACER BETWEEN THE RUBBER AND THE EDGE OF THE DOOR, AS SHOWN.

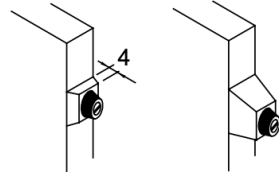

TOTAL DISAPPEARANCE PARTIAL DISAPPEARANCE

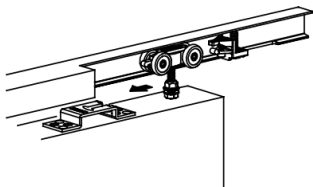

SLOT THE HANGERS INTO THE SLIDING TRACK AND THE RETAINING HOOK FIT THE DOOR PANELS TO THE HANGERS AND FIX THE SLIDING.

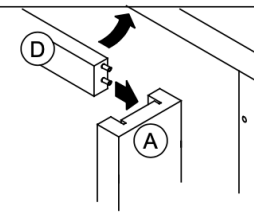

SLOT CROSS PIECE "D" TO THE ALREADY FITTED JAMB "B". FIX IN JAMB "A", CHECK HIS VERTICAL POSITIONS AND FASTEN TO THE FRAME.

125

UK

IMPERIAL

FIX THE REMAINING JAMB "B"

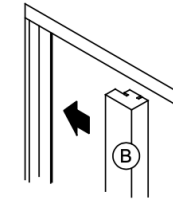

FIT CROSS PIECE "C" SO THAT IT CAN BE EASILY REMOVED FOR ADJUSTMENT OR ROUTINE MAINTENANCE PURPOSES.

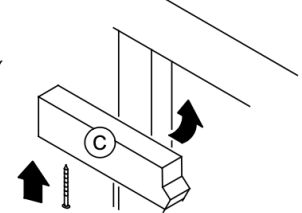

DOOR POSTS

SINGLE DOOR

DOOR SIZE			OPENING SIZE		END POSTS SIZE					
Lp x Hp			L x H		A		B		C / D	
in	mm	n°	mm	mm	mm	n°	mm	n°	mm	n°
24"	78"	610 x 1980	580	1970	2020	1	2020	2	580	1+1
27"	78"	686 x 1980	656	1970					656	
30"	78"	762 x 1980	732	1970	2020	1	2020	2	732	1+1
33"	78"	838 x 1980	808	1970					808	
36"	78"	914 x 1980	884	1970	2020	1	2020	2	884	1+1

DOUBLE DOOR

DOOR SIZE			OPENING SIZE		END POSTS SIZE					
Lp x Hp			L x H		B		C / D			
in	mm	n°	mm	mm	mm	n°	mm	n°	mm	n°
24"	78"	610 x 1980	1160	1970	2020	4	1464	1+1	1160	1+1
27"	78"	686 x 1980	1312	1970					1312	
30"	78"	762 x 1980	1464	1970	2020	4	1464	1+1	1464	1+1
33"	78"	838 x 1980	1616	1970					1616	
36"	78"	914 x 1980	1768	1970	2020	4	1768	1+1	1768	1+1

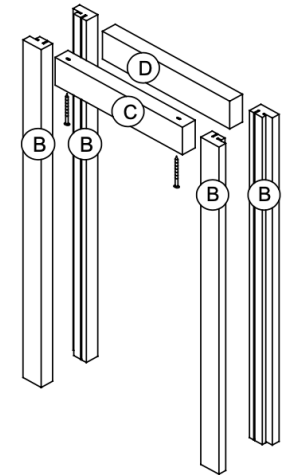
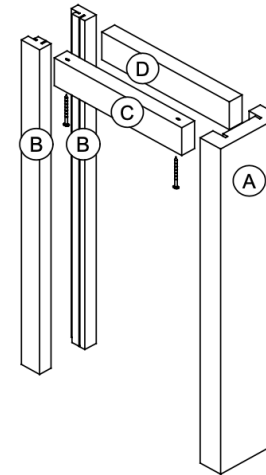

FINISHED WALL 125 mm

