

Before assembly

- We recommend that time is taken to read the instructions before starting assembly, then follow the easy step by step guide. The instruction sheet is only a guide to the assembly. Certain items may not be shown to scale.
- Check all components prior to assembly
- This product should be assembled by no less than two people
- Drill all components where indicated
- Gloves are recommended when handling components



Recommended tools for assembly

- Power Drill/Screwdriver
- Cross-head drill bit
- 3mm diameter drill bit
- 6mm diameter drill bit
- 12mm diameter drill bit
- Tape measure
- Hammer
- Sharp knife
- Spirit level
- Step ladder
- Silicon sealant

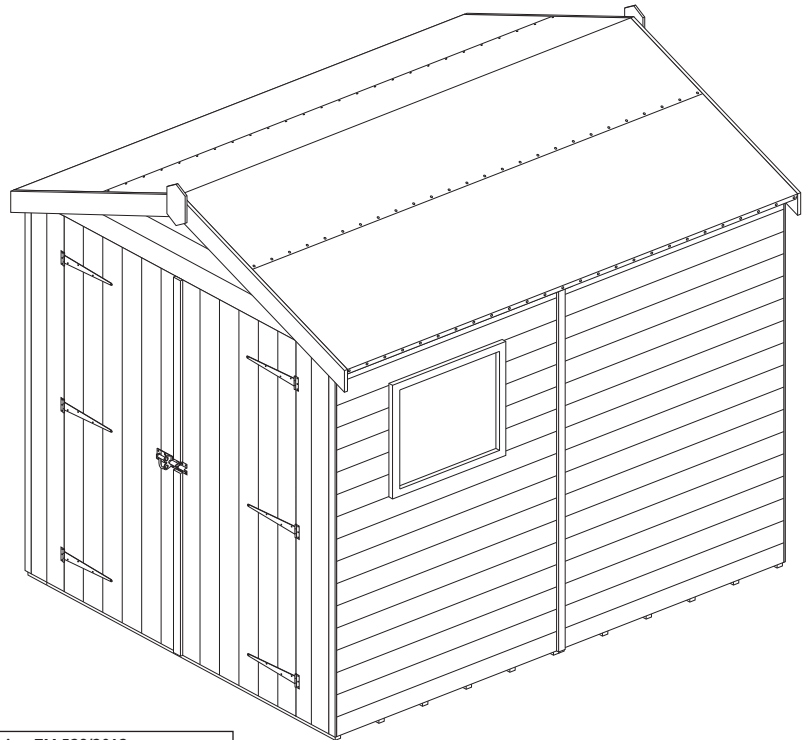

No.	Components	Qty.
1	Floor	2
2	Side wall panel (Width 1174mm)	3
3	Window panel (Width 1174mm)	1
4	Back wall panel (Width 860mm)	2
5	Front panel (Width 190mm)	2
6	Apex panel	2
7	Roof rafter	2
8	Roof rafter support block	2
9	Roof rafter brace	1
10	Roof rafter block (Length 150mm)	4
11	Roof purlin (Length 1174mm)	4
12	Felt batten (Length 1186mm)	4
13	Roof panel	4
14	Roof felt roll (5m)	1
15	Roof ridge felt roll (2.5m)	1
16	Door header rail (28x28x1340mm)	1
17	Door rebate strip (12x22x1685mm)	2
18	Left door (tower bolt mounting blocks)	1
19	Right door	1
20	Door weatherstrip (12x48x830mm)	2
21	Coverstrips (12x40x1715mm)	7
22	Window frame	1
23	Glazing (560x520mm)	1
24	Window beading (15x15x565mm)	2
25	Window beading (15x15x489mm)	2
26	Bargeboards	4
27	Finial	2

Biocidal Products Regulation EU 528/2012

Wolmanit® CX treated wood, is a treated article incorporating biocidal products: copper hydroxide carbonate, bis(N-cyclohexyl-diazonium-dioxy)-copper and Boric Acid. They protect wood against fungal decay, rot and insect attack. Wear gloves when handling freshly treated wood. Avoid breathing dust when cutting wood. Dispose of off-cuts responsibly.

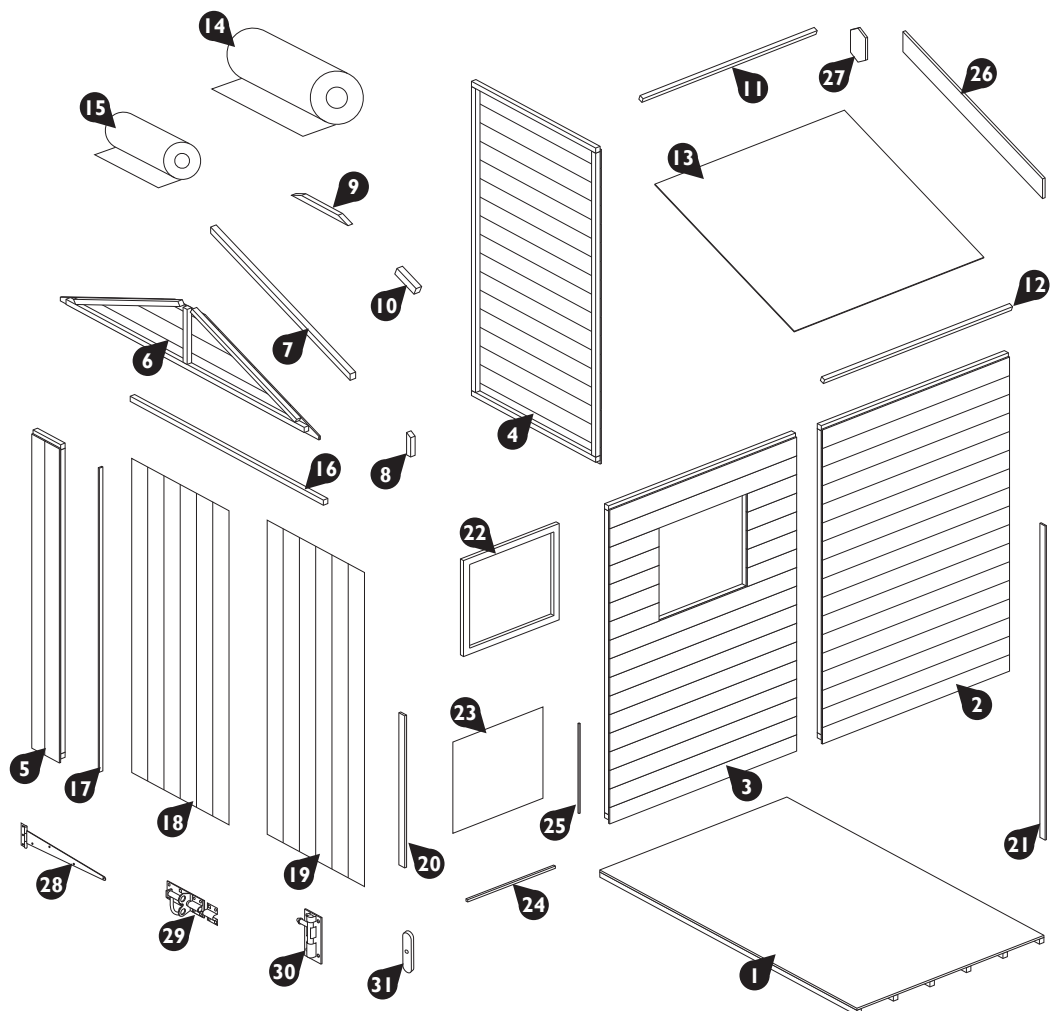

No.	Fixing Kit	Qty.
28	T-Hinge	6
29	Pad bolt	1
30	Tower bolt	2
31	Turn button	1
32	50mm coach bolt	4
33	Nut	4
34	Washer	4
35	60mm screws	14
36	50mm screws	48
37	40mm screws	4
38	32mm screws	44
39	25mm screws	49
40	20mm screws	6
41	19mm round head screws	12
42	30mm nails	65
43	25mm panel pins	12
44	10mm felt nails	128

1. Floor

! Important

Prepare a firm level area that is slightly larger than the floor, for the shed to sit. To protect the floor and validate the anti-rot guarantee, adequate provision must be made to ensure ground contact is avoided. The building must not be allowed to sit in pooled water during wet conditions and air must be able to circulate underneath the building. Recommended base options include either:

- Concrete pad
- Slabs
- Decking
- 50x50mm pressure treated timber bearers (minimum requirement)

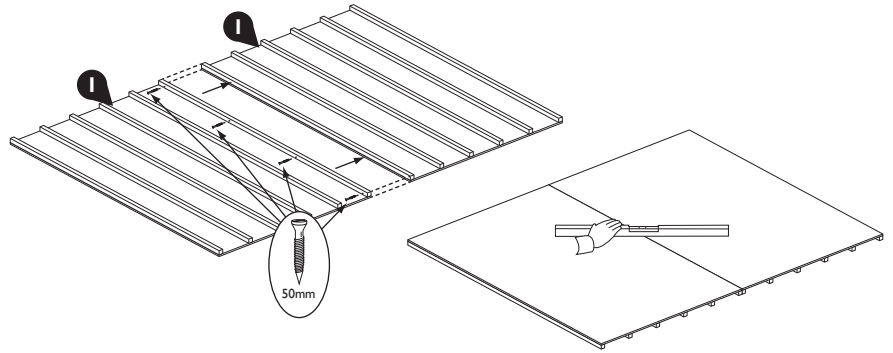

2. Wall Panels



Drill pilot holes with a 3mm drill for each screw in this section.

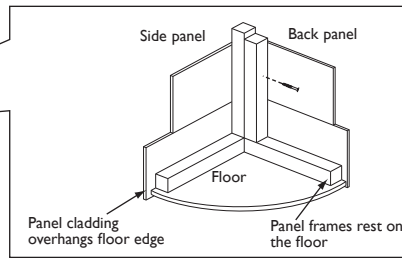
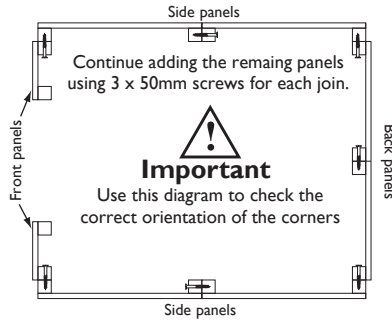
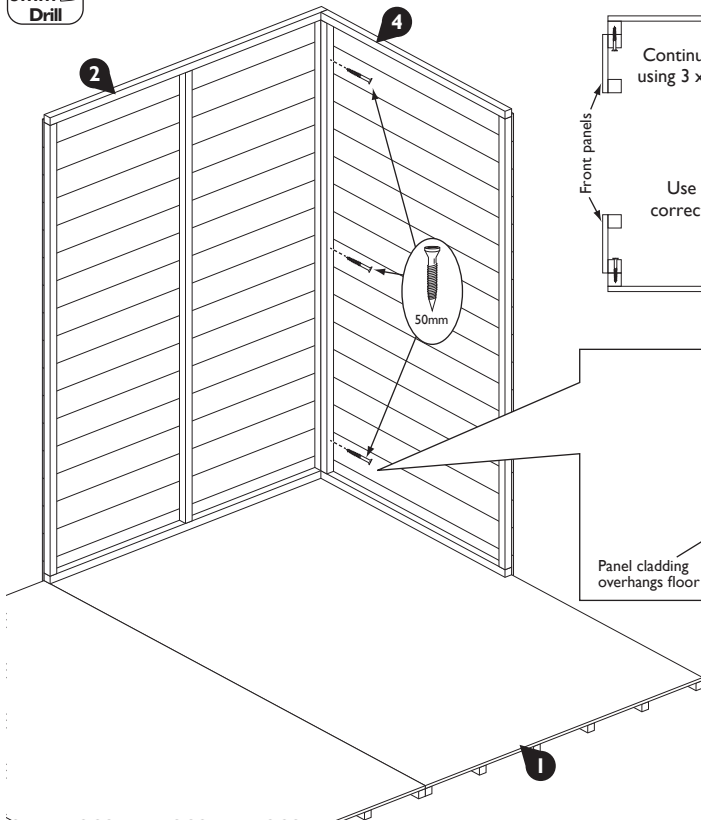

! Important

The window panel (5) can be swapped with any side wall panel (2).

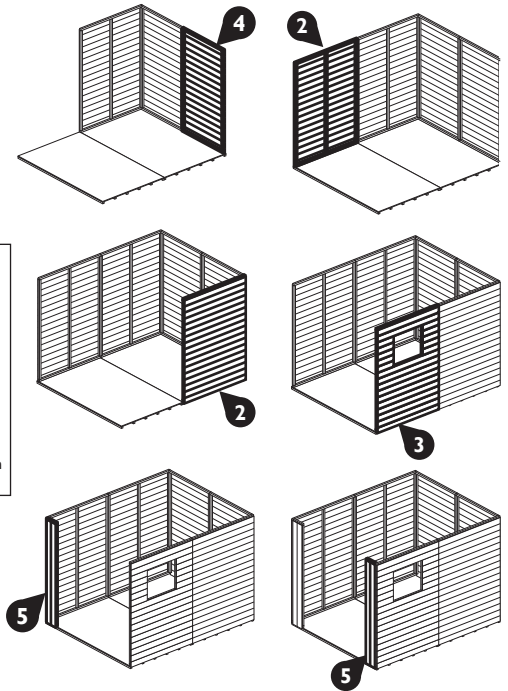

3. Apex Panels



Drill pilot holes with a 3mm drill for each screw in this section.

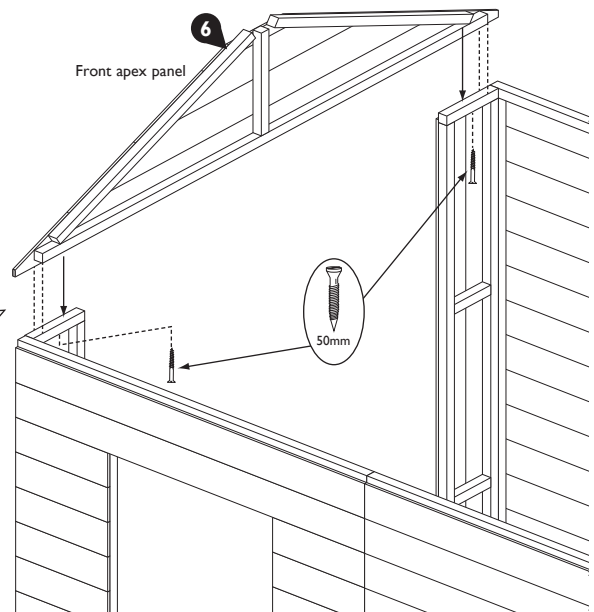
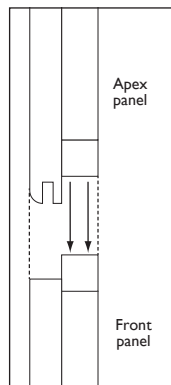
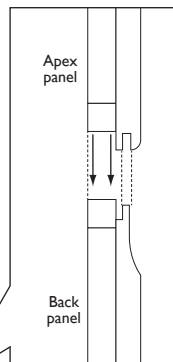
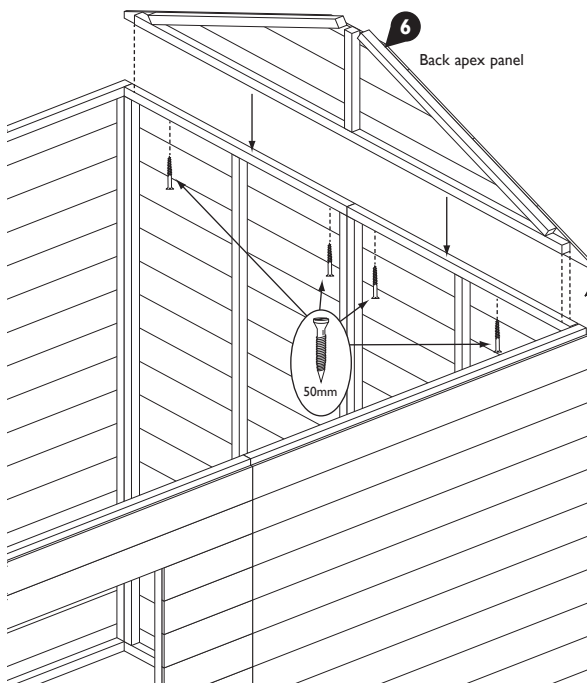

4. Door header Rail & Door Rebate Strips



Drill pilot holes with a 3mm drill for each screw in this section.

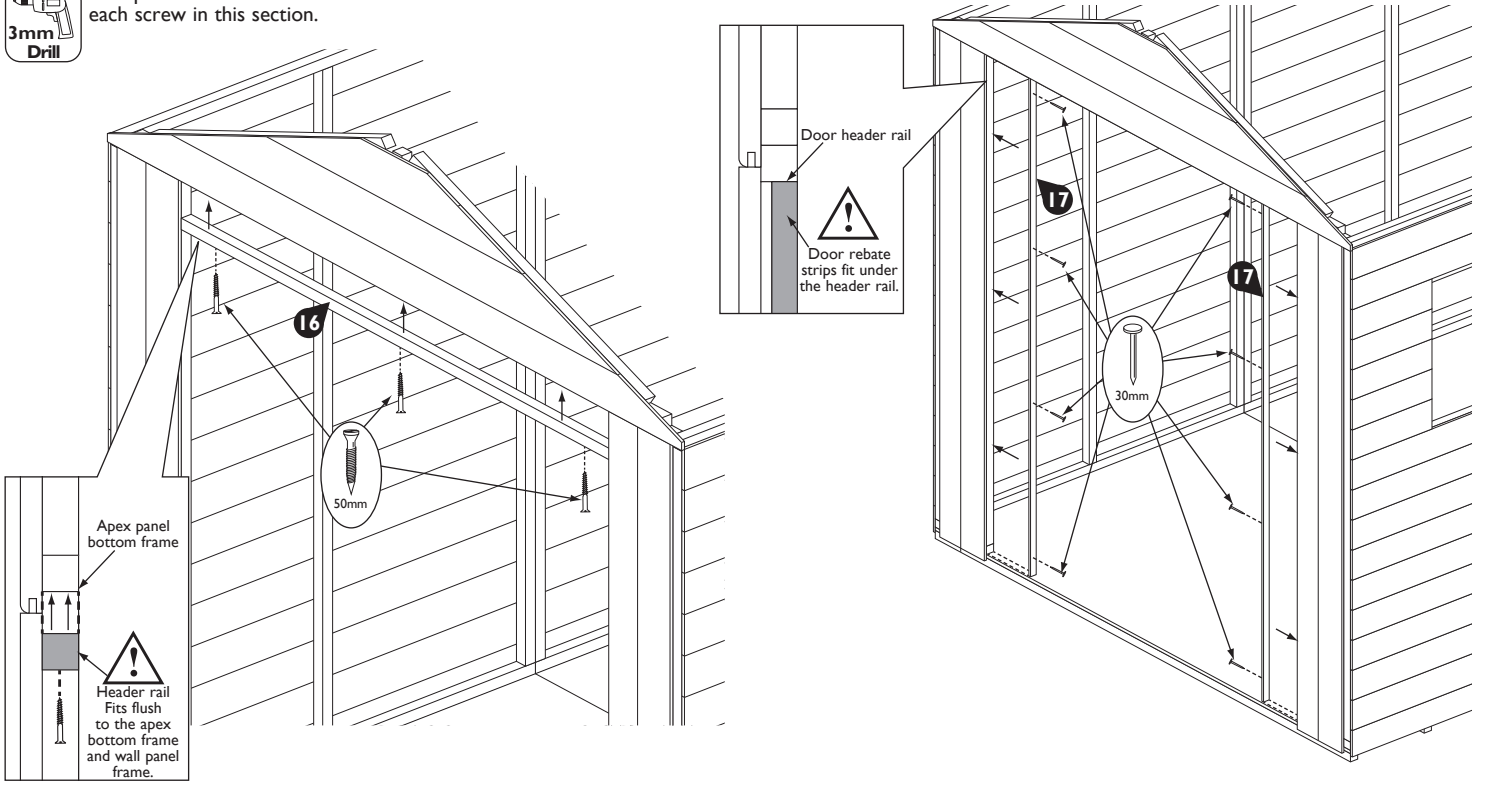

5. Roof Rafters



Drill pilot holes with a 3mm drill for each screw in this section.

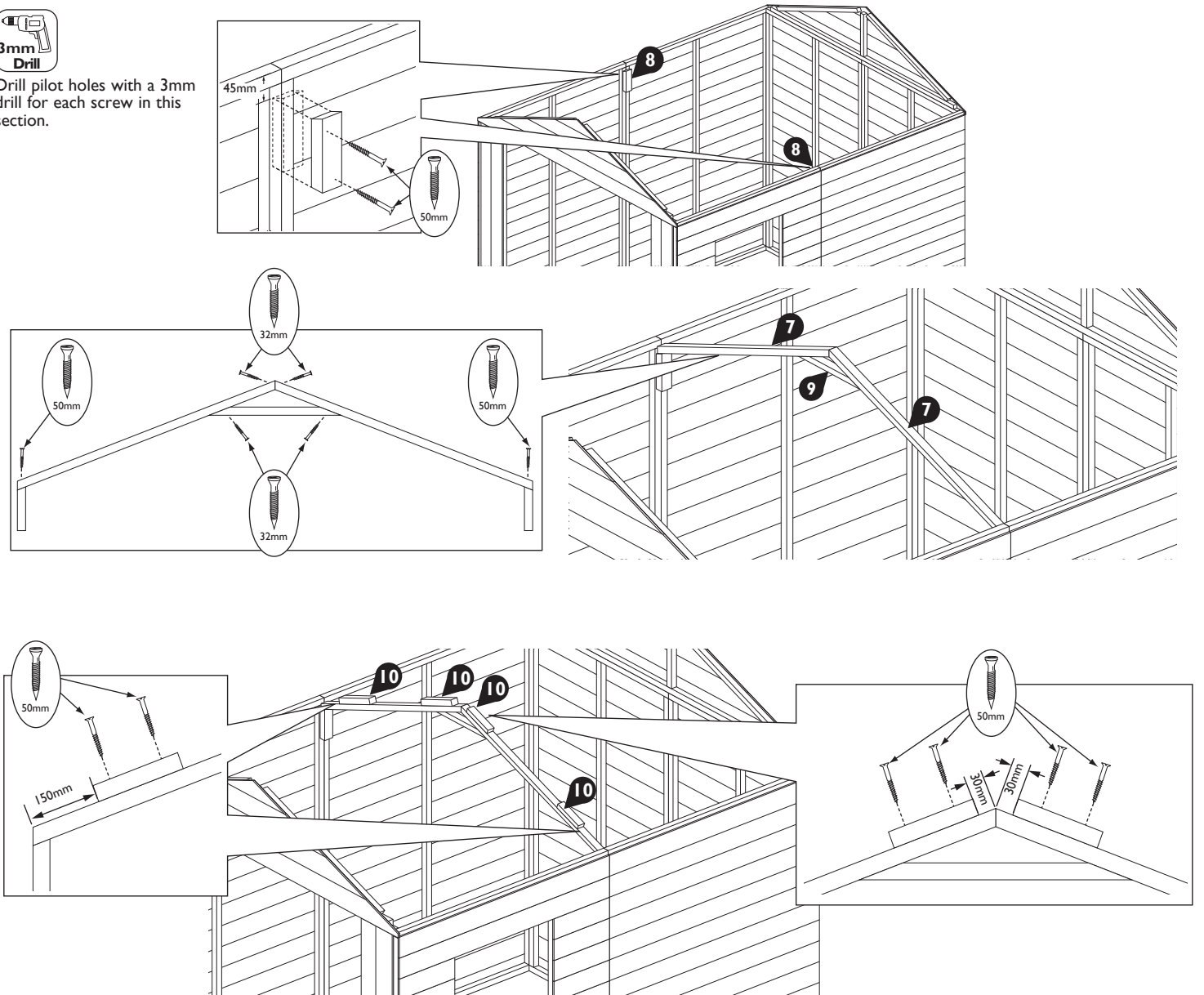

6. Roof Panel, Felt Battens & Purlins



Important

Construct 2 left-handed and
2 Right-handed roof panel assemblies

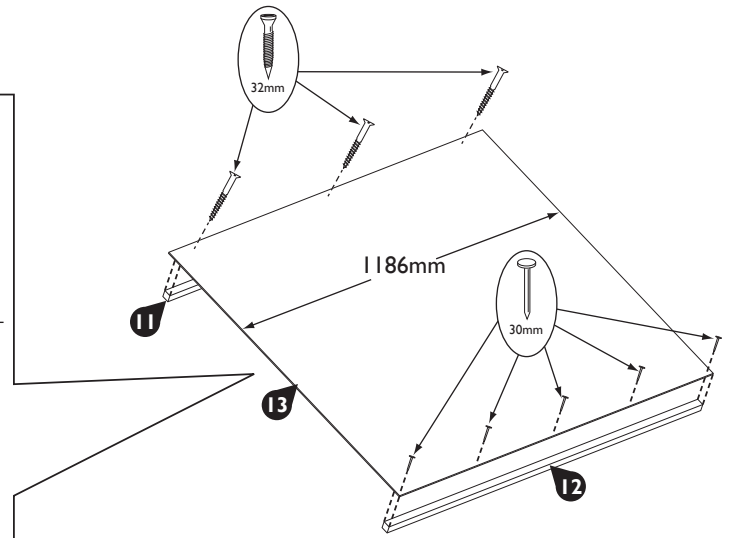
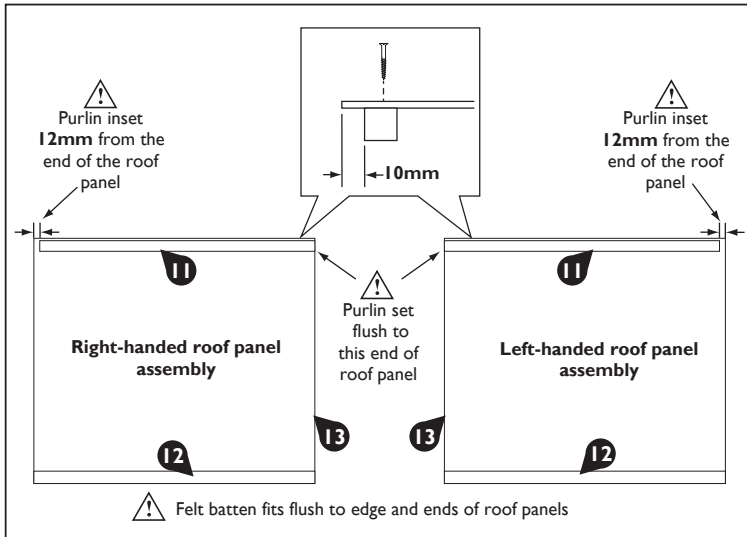

7. Attach Roof Panels



Hook the roof purlins on to
the apex and centre roof rafter.

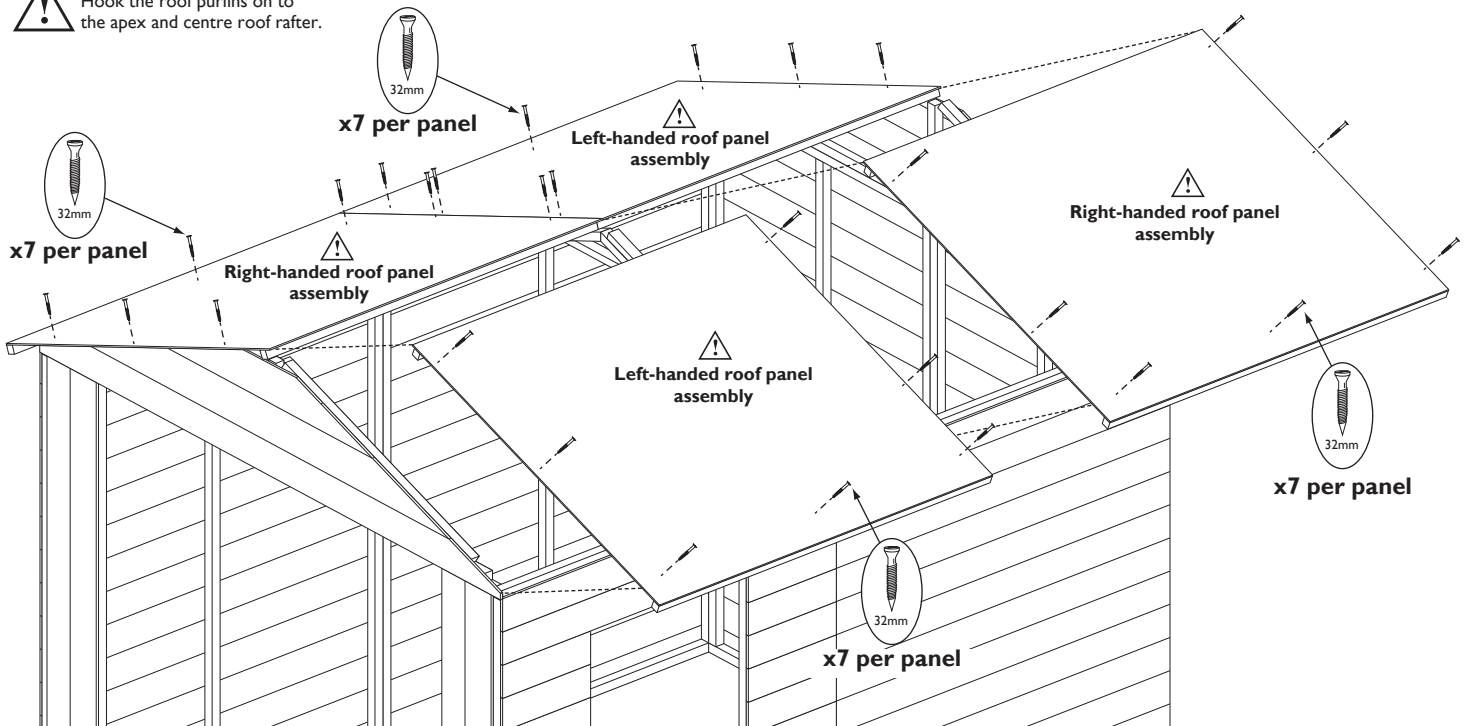

8. Secure Walls to Floor



Drill pilot holes with a
3mm drill for each screw
in this section.

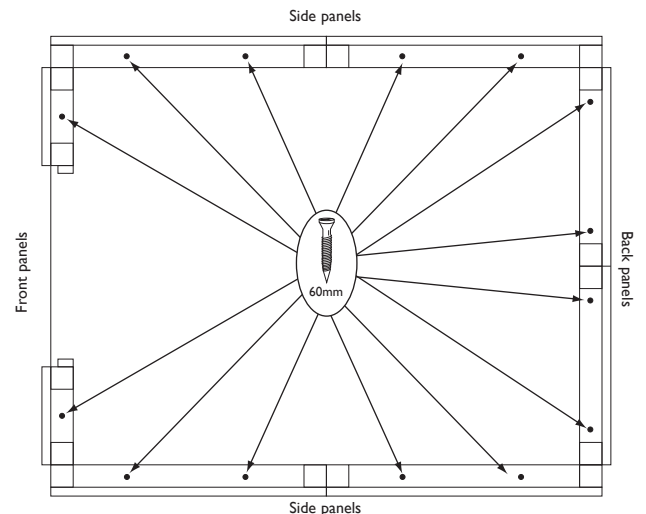
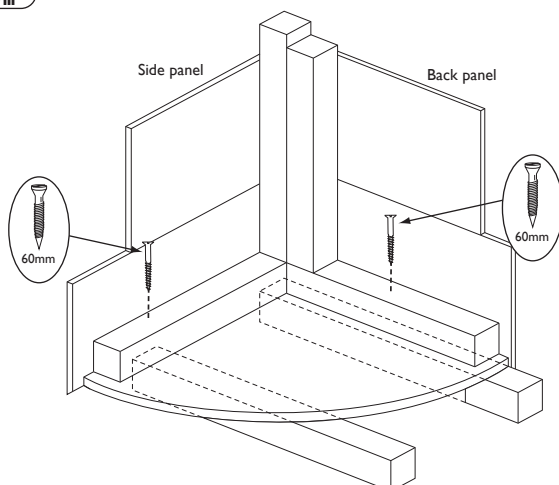

12. Roof Felt

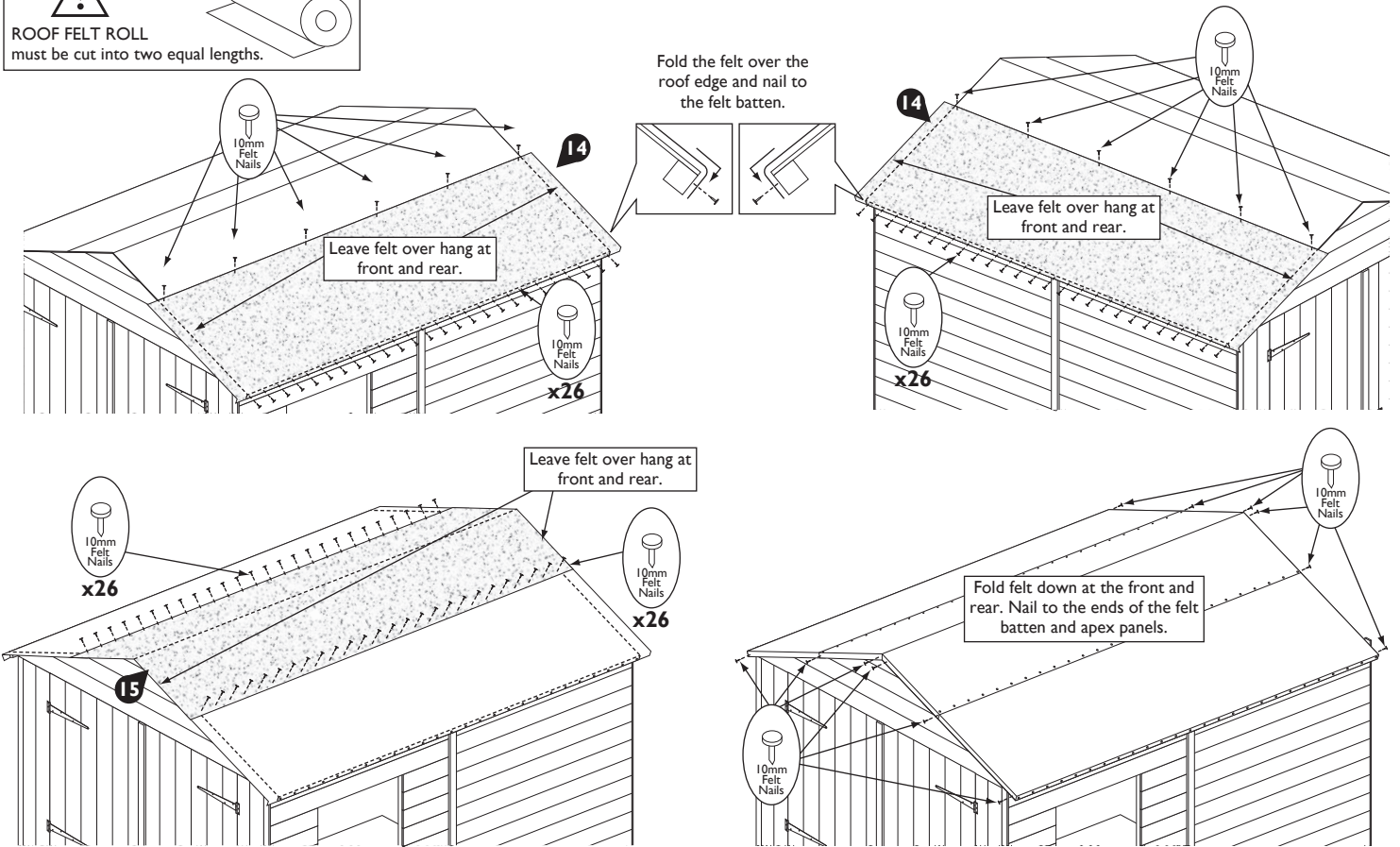
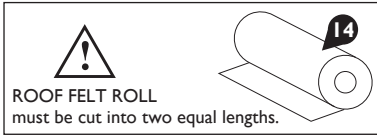

13. Bargeboards, Finials & Window

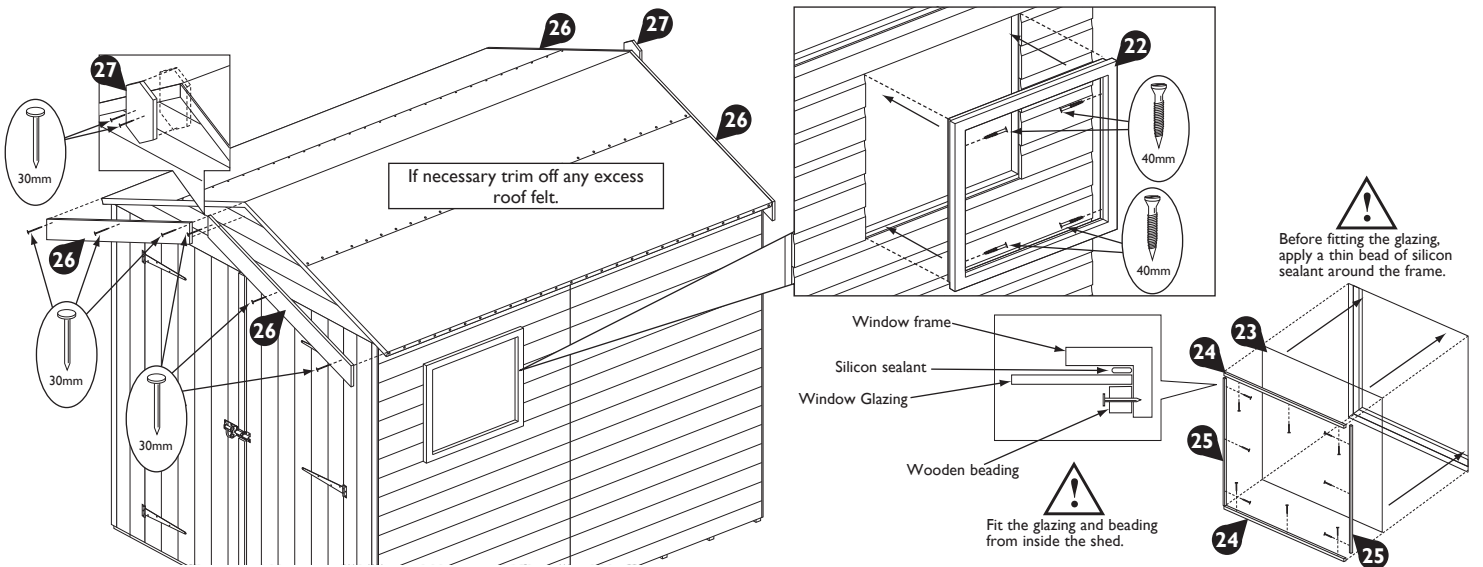

Important information - Retain For Future Reference

Please dispose of all packaging responsibly and recycle where possible in line with local authority requirements. Pressure treated Shiplap buildings require no further preservative treatment. However they can be painted or stained if required. To protect the floor and **validate the anti-rot guarantee**, adequate provision must be made to ensure ground contact is avoided. The building must not be allowed to sit in pooled water during wet conditions and air must be able to circulate underneath the building. Recommended base options include either concrete pad, slabs, decking. The minimum requirement is 50x50mm pressure treated timber bearers.

Timber Information.

As timber is a natural material, there are certain weather conditions that may affect the materials properties. In times of excessive dry spells the material may lose some of its internal moisture causing a certain degree of shrinkage on a panel and in periods of excessive rain there will be a certain amount of swelling throughout the wooden panels. This process can not be avoided. If you have problems with certain boards shrinking in dry spells try to decrease the amount of direct sunlight on the building or the amount of air passing over the building. During hot spells spray water directly onto the panels with the aid of a garden hose.

If in doubt of any aspect regarding the assembly, use or safety of your building please contact us:

Help Line: (Normal Office Hours) 01829 261 121

Email: support@rowgar.co.uk

ROWLINSON GARDEN PRODUCTS LIMITED
Green Lane
Wardle Nr. Nantwich
Cheshire
CW5 6BN
www.rowgar.co.uk

We constantly improve the quality of our products, occasionally the components may differ from the components shown and are only correct at time of printing. We reserve the right to change the specification of our products without prior notice.

2024 © Rowlinson Garden Products Ltd