



Installation and operating instructions

Air to water heat pump

**Compress 2000 AWF**

CS2000AWF 4-30 R-S/T

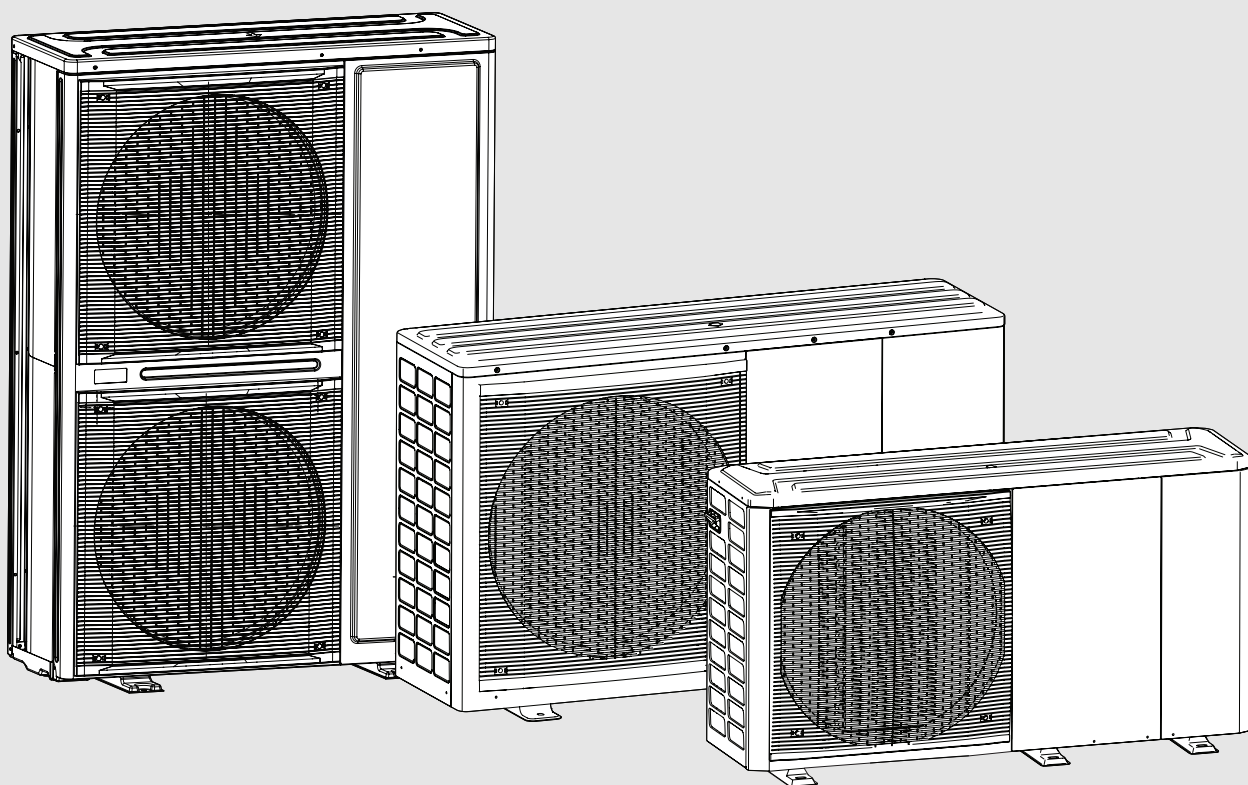

## Table of contents

<b>1</b>	<b>Explanation of symbols and safety instructions</b>	<b>4</b>	<b>6</b>	<b>Installation</b>	<b>36</b>
1.1	Explanation of symbols	4	6.1	General installation requirements	36
<b>2</b>	<b>Safety considerations</b>	<b>4</b>	6.2	Standard installation	36
2.1	General safety instructions	4	6.3	Installation in extreme weather conditions	37
2.2	Declaration of Conformity	4	6.3.1	Unit exposed to strong wind	37
2.3	Manual	4	6.3.2	Unit exposed to direct sunlight	38
2.4	Warning/risk situations	4	6.3.3	Unit exposed to heavy rain or snow	38
2.5	Intended use	4	6.4	Ground assembly	39
2.6	Installation	4	6.4.1	Dimensions for ground fixing	40
2.7	Maintenance	5	6.5	Wall assembly	41
2.8	Changes	5	6.6	Handling	43
2.9	Fault or malfunction	5	6.7	Access to internal parts of the unit	43
2.10	User training	5	6.7.1	DHW tank	44
2.11	Data updating	5	6.7.2	Tank provided by a third party	44
2.12	Information for the User	5	6.8	Condensate drain	44
2.12.1	Requirements to the installer	5	<b>7</b>	<b>Water connections</b>	<b>46</b>
2.12.2	Unit identification	5	7.1	Preliminary check	47
2.12.3	Serial number	5	7.1.1	Water circuit	47
2.12.4	Assistance request	5	7.1.2	Water characteristics	47
<b>3</b>	<b>Refrigerant information</b>	<b>5</b>	7.1.3	Water quality in the heating system	47
<b>4</b>	<b>Description of the system</b>	<b>6</b>	7.1.4	Water quality for potable water (DHW)	48
4.1	Main components	6	7.2	General system requirements (to be provided by the customer)	48
4.1.1	Scope of delivery	6	7.2.1	Air vent valves	48
4.1.2	Sizes CS2000AWF 4 R-S to CS2000AWF 6 R-S	6	7.2.2	Water filter on Domestic Hot Water side	48
4.1.3	Sizes CS2000AWF 8 R-S to CS2000AWF 10 R-S	7	7.2.3	System side water filter	48
4.1.4	Sizes CS2000AWF 12 R-S/CS2000AWF 12 R-T to CS2000AWF 16 R-S/CS2000AWF 16 R-T	8	7.3	Water pipes	48
4.1.5	Sizes CS2000AWF 18 R-T to CS2000AWF 30 R-T	9	7.3.1	General instructions for piping	48
4.2	Hydraulic module	10	7.3.2	Installing a water filter	48
4.2.1	Sizes CS2000AWF 4 R-S to CS2000AWF 6 R-S	10	7.3.3	Magnetic dirt separator filter	49
4.2.2	Sizes CS2000AWF 8 R-S to CS2000AWF 16 R-S/CS2000AWF 16 R-T	11	7.3.4	Installation in new systems	49
4.2.3	Sizes CS2000AWF 18 R-T to CS2000AWF 30 R-T	12	7.3.5	Installation in existing systems	49
4.3	Technical data	13	7.4	Water circuit frost protection	49
4.3.1	Technical specifications	13	7.4.1	Using an antifreeze liquid	49
4.3.2	Operating range	14	7.4.2	Using automatic frost protection valves	50
4.3.3	Capacity curve of the circulation pump	15	7.4.3	Protection of flow switch against frost	50
4.3.4	System solutions	16	7.4.4	Protection of Domestic Hot Water storage tank	51
4.3.5	Explanation of symbols	30	7.5	Pipe insulation	51
<b>5</b>	<b>Before installation</b>	<b>31</b>	7.6	Water volume, system pressure and expansion tank control	51
5.1	Warnings	31	7.6.1	System pressure and expansion tank control	51
5.2	Reception	31	7.6.2	Sizes CS2000AWF 4 R-S to CS2000AWF 16 R-S/CS2000AWF 16 R-T	51
5.3	Storage	31	7.6.3	Sizes CS2000AWF 18 R-T to CS2000AWF 30 R-T	51
5.4	Handling	31	7.7	Filling / topping up with water	52
5.5	Lifting	32	<b>8</b>	<b>Electrical connections</b>	<b>53</b>
5.6	Removing packaging	33	8.1	Precautions for electrical connections	53
5.7	Removing the transport bracket	33	8.2	General diagram	54
5.8	Dimensions and weights	34	8.3	Control box	55
5.8.1	Sizes CS2000AWF 4 R-S to CS2000AWF 6 R-S	34	8.3.1	Sizes CS2000AWF 4 R-S to CS2000AWF 16 R-S/CS2000AWF 16 R-T	55
5.8.2	Sizes CS2000AWF 8 R-S to CS2000AWF 16 R-S/CS2000AWF 16 R-T	34	8.3.2	Sizes CS2000AWF 18 R-T to CS2000AWF 30 R-T	55
5.8.3	Sizes CS2000AWF 18 R-T to CS2000AWF 30 R-T	35	8.4	Location of connections	55
			8.4.1	Sizes CS2000AWF 4 R-S to CS2000AWF 6 R-S	55
			8.4.2	Sizes CS2000AWF 8 R-S to CS2000AWF 16 R-S/CS2000AWF 16 R-T	56

8.4.3	Sizes CS2000AWF 18 R-T to CS2000AWF 30 R-T	56	10.9	Temperature control	102
8.5	Electrical connections	57	10.10	Select operation mode	103
8.5.1	Precautions when connecting to the power supply	57	10.11	DEFAULT TEMPERATURES	103
8.5.2	Electrical connection specifications	59	10.12	CLIMATE TEMP. SET. (Climate temperature setting)	104
8.5.3	Connection Terminal Block	60	10.13	ECO MODE	105
8.6	Terminal block connection specifications	62	10.14	Domestic hot water (DHW)	106
8.6.1	Terminal block CN11	62	10.14.1	DISINFECT (anti-legionella)	106
8.6.2	Terminal block CN7	63	10.14.2	FAST DHW	107
8.7	SMART GRID - Photovoltaic management	64	10.14.3	TANK HEAT	107
8.8	Dip-switch setting	65	10.14.4	DHW PUMP (recirculation) if present	108
8.9	User interface	66	10.15	Time schedule	109
8.9.1	User interface installation requirements	66	10.15.1	TIMER	109
8.10	Zone thermostat	70	10.15.2	WEEKLY SCHEDULE	110
8.11	Units connected in cascade	71	10.15.3	SCHEDULE CHECK	111
8.11.1	Water connections	71	10.15.4	CANCEL TIMER	111
8.11.2	Electrical connections	71	10.16	Options	112
8.11.3	Backup master unit	71	10.16.1	SILENT MODE	112
8.11.4	Configuration	72	10.16.2	HOLIDAY AWAY	113
<b>9</b>	<b>Start-up - initial settings and functions</b>	<b>72</b>	10.16.3	HOLIDAY AT HOME	114
9.1	User interface	72	10.16.4	BACKUP HEATER	115
9.1.1	Keypad	72	10.16.5	CHILD LOCK	115
9.1.2	Display and icons	73	10.16.6	ENERGY ANALYSIS	117
9.1.3	First switch-on and language selection	75	10.17	Service information	119
9.1.4	Menu structure	75	10.17.1	SERVICE INFORMATION	119
9.1.5	Functions reserved for the Technician	75	10.17.2	SERVICE CALL	119
9.1.6	Terminology used	76	10.17.3	ERROR CODE	119
9.2	Initial unit setting (requires a specialised Technician)	77	10.17.4	PARAMETER	120
9.2.1	DHW (Domestic Hot Water) mode settings	77	10.17.5	DISPLAY	120
9.2.2	Cooling mode settings	80	10.18	OPERATION PARAMETER	120
9.2.3	Heating mode settings	81	<b>11</b>	<b>MODBUS registers</b>	<b>122</b>
9.2.4	Automatic mode settings	82	11.1	Controls	122
9.2.5	Control settings	82	11.2	States	123
9.2.6	Zone thermostat settings	84	11.3	States of units in cascade	124
9.2.7	Additional heating source settings	84	11.4	Alarms	126
9.2.8	Holiday away function settings	87	11.5	Password-protected unit parameters	127
9.2.9	Serviceman contact settings	87	<b>12</b>	<b>Maintenance</b>	<b>130</b>
9.2.10	Restore factory settings	87	<b>13</b>	<b>Troubleshooting</b>	<b>131</b>
9.2.11	Test mode settings	87	13.1	General problems	131
9.2.12	Special function settings	89	13.2	Error codes	133
9.2.13	Automatic restart settings	90	<b>14</b>	<b>Environmental protection and disposal</b>	<b>137</b>
9.2.14	Unit's power supply limitation settings	90	<b>15</b>	<b>Data Protection Notice</b>	<b>137</b>
9.2.15	Unit input signal settings	91			
9.2.16	Cascade system settings	91			
9.2.17	Other HMI settings	91			
9.2.18	Climate curve setting	91			
<b>10</b>	<b>Control</b>	<b>95</b>			
10.1	Explanation of buttons	95			
10.2	Explanation of the display	96			
10.3	Menu structure	97			
10.4	Home page	98			
10.5	Menu structure	99			
10.6	Unlocking the keypad	99			
10.7	Unit ON/OFF	100			
10.8	Controls OFF/ON	100			

# 1 Explanation of symbols and safety instructions

## 1.1 Explanation of symbols

### Warnings

In warnings, signal words at the beginning of a warning are used to indicate the type and seriousness of the ensuing risk if measures for minimising danger are not taken.

The following signal words are defined and can be used in this document:

**DANGER**  
**DANGER** indicates that severe or life-threatening personal injury will occur.

**WARNING**  
**WARNING** indicates that severe to life-threatening personal injury may occur.

**CAUTION**  
**CAUTION** indicates that minor to medium personal injury may occur.

**NOTICE**  
**NOTICE** indicates that material damage may occur.

### Important information

The info symbol indicates important information where there is no risk to people or property.

### Additional symbols

Symbol	Meaning
▶	a step in an action sequence
→	a reference to a related part in the document
•	a list entry
–	a list entry (second level)

Table 1

## 2 Safety considerations

### 2.1 General safety instructions

This manual provides the correct procedure for installation, use and maintenance of the unit. It is mandatory to read the manual carefully so it will save time during operations and avoid causing damages to things and injure people.

Pay particular attention to warnings, prohibitions and danger signs that indicate important operations or informations; operations that cannot be done, that compromise the functionality of the unit or which may cause damage to things or persons.

Operate in compliance with the safety regulations in force.

To perform the operations use the following protective equipment:

- gloves
- goggles

- helmet
- headphones
- protective footwear
- protective knee pads

All operations must be carried out by professional and authorized contractors, trained on possible risks of general nature, electrical and deriving from operating with equipment under pressure. Only professional and authorized contractors can operate on the unit, as required by the current regulations.

Before any intervention, read chapter 7, page 46.

### 2.2 Declaration of Conformity

The design and operating characteristics of this product comply with the British, European and supplementary national requirements.

The UKCA and CE markings declare that the product complies with all the applicable British and European legislation, which is stipulated by attaching these markings.

You can request the complete text of the Declaration of Conformity from the UK address indicated in this document.

### 2.3 Manual

The manual ensures proper installation, use and maintenance of the unit. It is advisable to read this carefully so as to save time during the various operations.

- ▶ Follow the instructions given to prevent damage to persons or property.

### 2.4 Warning/risk situations

The units have been designed and created to prevent injuries to people. During designing it is not possible to plan and operate on all risky situations.

Installations, starting, maintenance and repair requires specific knowledge; if these processes are carried out by inexperienced personnel, they may cause damages to things and injuries to people.

The manufacturer accepts no responsibility if the equipment is used for any purpose other than the intended use.

Use the unit only:

- to cool or heat water or a glycol water mix for heating and air-conditioning.
- to keep the limits foreseen in the technical schedule and in this manual.

### 2.5 Intended use

The unit is intended only:

- for heating or cooling of water or water-glycol.
- within the limits defined in the technical data sheet and in this manual.

### 2.6 Installation

Outdoor installation

The location, the water, refrigeration and electrical systems must be determined by the system designer according to local regulations in force.

- ▶ Follow local safety regulations throughout all operations.
- ▶ Verify that the power network characteristics are in compliance with data indicated on the serial number label of the unit.

**2.7 Maintenance**

Schedule periodic inspections and maintenance work in order to prevent or reduce repair costs.

- ▶ Disconnect voltage before any operation and wait 10 minutes before any action on electrical components.

**2.8 Changes**

All modifications to the unit will invalidate the warranty and void the manufacturer's liability.

**2.9 Fault or malfunction**

- ▶ Disable the unit immediately if there is a fault or malfunction.
- ▶ Contact a service centre authorised by the manufacturer.
- ▶ Request the use of original spare parts.

Using the unit when there is a fault or malfunction:

- voids the warranty
- may compromise the safety of the unit
- can increase repair costs and times

**2.10 User training**

The installer is to train the user on:

- Switch on/off
- Change setpoint
- Standby mode
- Maintenance
- What to do/not do in case of failure

**2.11 Data updating**

The continual improvements to the product may result in changes to the data shown in this manual.

- ▶ Visit the manufacturer's website for up-to-date data.

**2.12 Information for the User**

- ▶ Keep this manual together with the wiring diagram in an accessible place for the operator.
- ▶ Make a note of the unit's identification data so that they can be provided to the service centre in the event of a service request (→ chapter 11.4, page 126).
- ▶ Provide a logbook dedicated to the unit in which any interventions carried out on the unit can be noted and tracked, making it easier to suitably record the various operations and facilitate troubleshooting.

**2.12.1 Requirements to the installer**

Ensure the installer is trained in:

- Switch on/off
- Change setpoint
- Standby mode
- Maintenance
- What to do/not do in case of failure

**2.12.2 Unit identification**

The serial number label is positioned on the unit to identify all the features of the unit.

The serial number label bears the information required by the regulations, such as:

- the type of unit
- the serial number (12 characters)
- year of manufacture
- wiring diagram number
- electrical data
- type of refrigerant
- refrigerant charge
- manufacturer's logo and address

The serial number label is not to be removed for any reason.



Tampering, removal, lack of identification labels or anything else that does not allow safe product identification, makes any installation and maintenance operation difficult.

**2.12.3 Serial number**

Uniquely identifies each unit. Allows the specific spare parts for the unit to be identified.

**2.12.4 Assistance request**

- ▶ Note down the characteristic data from the serial number label and record them in a table so that they are easily available when needed.

Series	Compress 2000 AWF
Size	
Serial number	
Year of manufacture	
Wiring diagram number	

**3 Refrigerant information**



**CAUTION**

**Greenhouse gases!**

This product contains fluorinated greenhouse gases covered by the Kyoto protocol.

- ▶ Limit any leaks, otherwise it will be a major contributor to the anthropogenic greenhouse effect.
- ▶ Do not discharge gas into the atmosphere.

**Type of refrigerant: R-32**

The refrigerant quantity is indicated on the unit plate.

Quantity of refrigerant charged at the factory and tons of equivalent CO<sub>2</sub>:

Size	Volume of refrigerant charged at the factory	
	Refrigerant / kg	Tons of equivalent CO <sub>2</sub>
CS2000AWF 4 R-S	1.40	0.95
CS2000AWF 6 R-S	1.40	0.95
CS2000AWF 8 R-S	1.40	0.95
CS2000AWF 10 R-S	1.40	0.95
CS2000AWF 12 R-S/ CS2000AWF 12 R-T	1.75	1.18
CS2000AWF 14 R-S/ CS2000AWF 14 R-T	1.75	1.18
CS2000AWF 16 R-S/ CS2000AWF 16 R-T	1.75	1.18
CS2000AWF 18 R-T	5.00	3.38
CS2000AWF 22 R-T	5.00	3.38
CS2000AWF 26 R-T	5.00	3.38
CS2000AWF 30 R-T	5.00	3.38

Table 2 Volume of refrigerant charged at the factory

Physical characteristics of R-32 refrigerant		
Safety class (ISO 817)	A2L	
GWP (Global Warming Potential)	675	t CO <sub>2</sub> eq. 100yr
LFL Low flammability limit	14.4% v/v	kg/ m <sup>3</sup> @atm, 23 °C
BV Burning velocity	6.7	cm/s
Normal boiling point	-51.7	°C
Self-ignition temperature	648	°C

Table 3 Physical characteristics of R-32 refrigerant

**WARNING**
**Flammable material!**

The refrigerant used inside this unit is flammable. A refrigerant leak that is exposed to an external ignition source can create fire risks.

## 4 Description of the system

### 4.1 Main components

#### 4.1.1 Scope of delivery

Description	Quantity
Technical documentation	1
Y filter	1
User interface	1
Water temperature probe (for T5/T1/Tw2/Tbt1 /Tsolar)	1
Condensate drain fitting	1
Cable tie	3
Termination heater for connecting M/S units in cascade	1

Table 4 Scope of delivery

#### 4.1.2 Sizes CS2000AWF 4 R-S to CS2000AWF 6 R-S

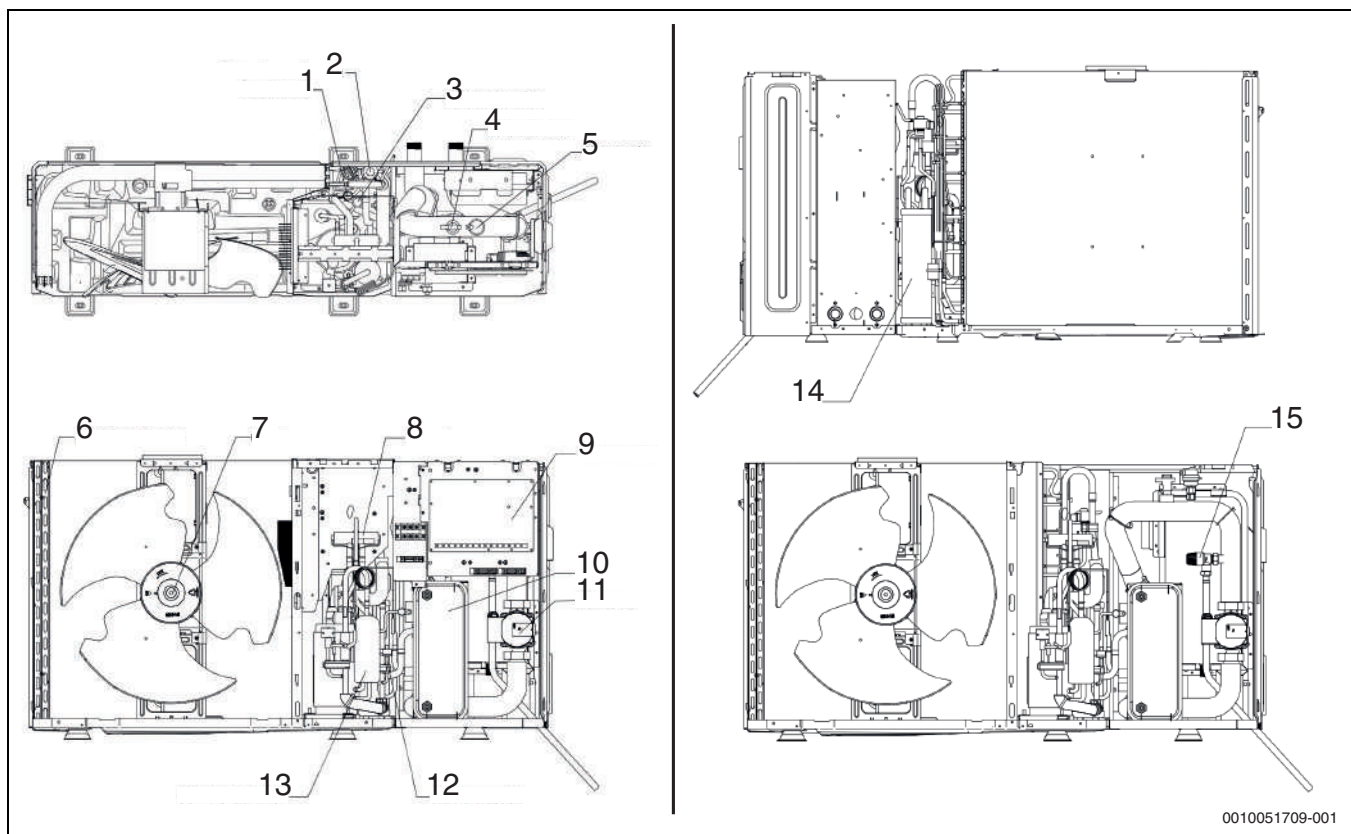

Fig. 1 Sizes CS2000AWF 4 R-S to CS2000AWF 6 R-S

- [1] Pressure sensor
- [2] Electronic expansion valve
- [3] HP pressure switch
- [4] Water flow switch
- [5] Air vent valve
- [6] Source exchanger: finned coil
- [7] Fan
- [8] 4-way valve
- [9] Main board
- [10] Water side heat exchanger
- [11] Water circulator
- [12] LP pressure switch
- [13] Compressor inverter
- [14] Gas-liquid separator
- [15] Water pressure relief valve

**4.1.3 Sizes CS2000AWF 8 R-S to CS2000AWF 10 R-S**

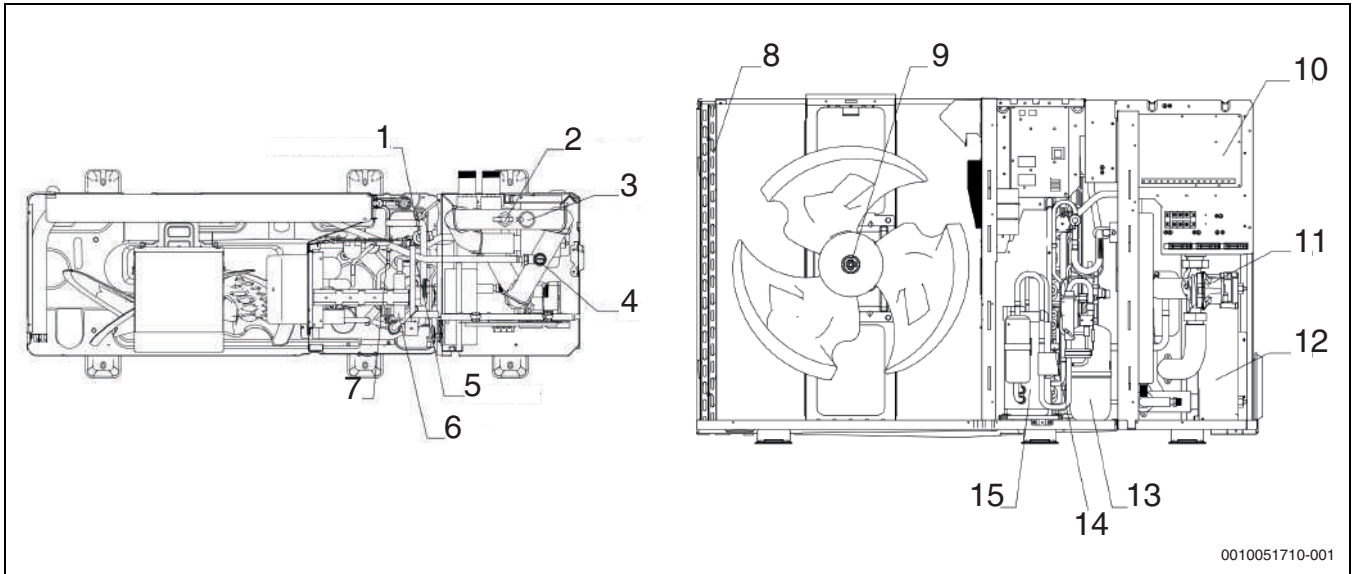

Fig. 2 Sizes CS2000AWF 8 R-S to CS2000AWF 10 R-S

- [1] Electronic expansion valve
- [2] Water flow switch
- [3] Air vent valve
- [4] Water pressure relief valve
- [5] Pressure sensor
- [6] 4-way valve
- [7] HP pressure switch
- [8] Source exchanger: finned coil
- [9] Fan motor
- [10] Main board
- [11] Water circulator
- [12] Water side heat exchanger
- [13] Gas-liquid separator
- [14] LP pressure switch
- [15] Compressor inverter

**4.1.4 Sizes CS2000AWF 12 R-S/CS2000AWF 12 R-T to CS2000AWF 16 R-S/CS2000AWF 16 R-T**

Fig. 3 Sizes CS2000AWF 12 R-S/CS2000AWF 12 R-T to CS2000AWF 16 R-S/CS2000AWF 16 R-T

- [1] HP pressure switch
- [2] 4-way valve
- [3] Pressure sensor
- [4] Electronic expansion valve
- [5] Gas-liquid separator
- [6] Water flow switch
- [7] Air vent valve
- [8] Water pressure relief valve
- [9] Source exchanger: finned coil
- [10] Fan motor
- [11] Main board
- [12] Water circulator
- [13] Water side heat exchanger
- [14] LP pressure switch
- [15] Compressor inverter

**4.1.5 Sizes CS2000AWF 18 R-T to CS2000AWF 30 R-T**

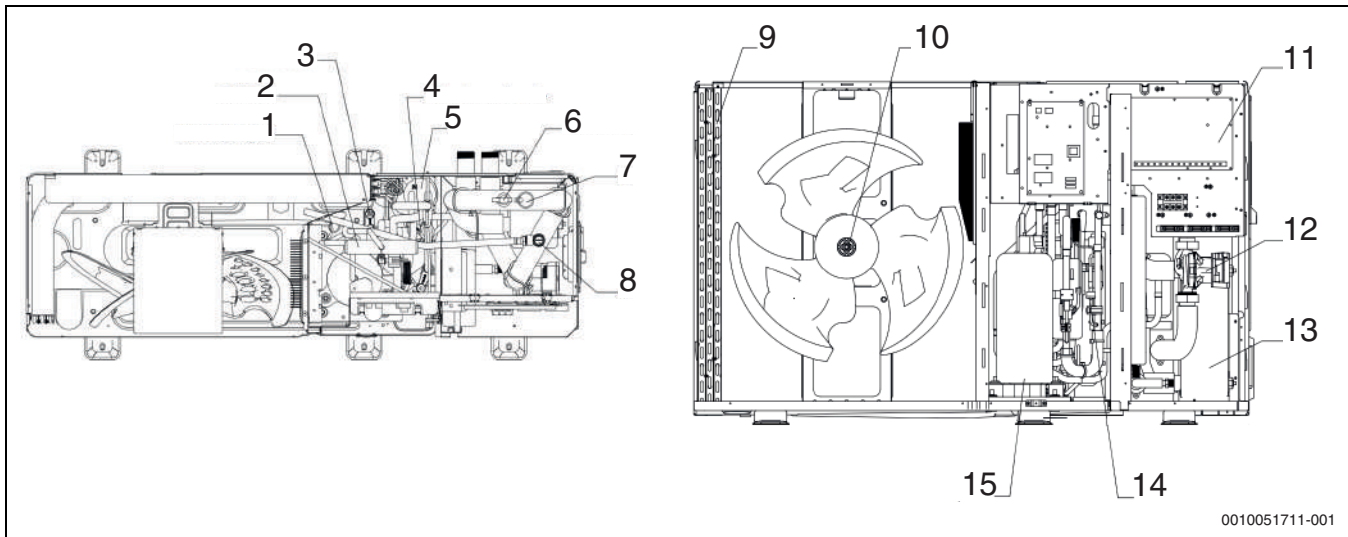
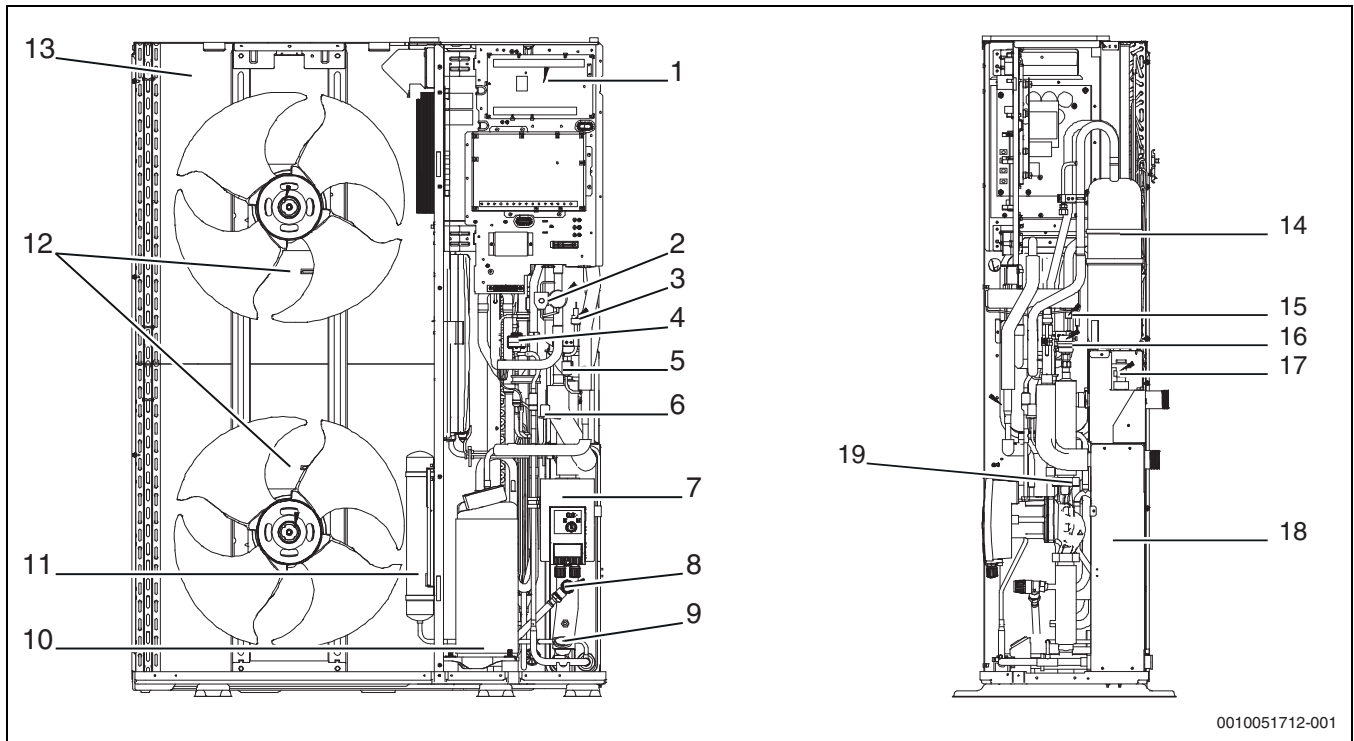

0010051712-001

Fig. 4 Sizes CS2000AWF 18 R-T to CS2000AWF 30 R-T

- [1] Main board
- [2] 4-way valve
- [3] Pressure sensor
- [4] Electronic expansion valve
- [5] HP pressure switch
- [6] LP pressure switch
- [7] Water circulator
- [8] Water pressure relief valve
- [9] Pressure gauge
- [10] Compressor inverter
- [11] Gas-liquid separator
- [12] Fan motor
- [13] Source exchanger: finned coil
- [14] Liquid receiver
- [15] Non-return valve
- [16] Air vent valve
- [17] Water flow switch
- [18] Water side heat exchanger
- [19] Expansion tank



The pictures in this manual are provided for illustrative purposes only. The appearance of your appliance may differ slightly from the illustrations shown here. Refer to the actual characteristics of the unit.

## 4.2 Hydraulic module

### 4.2.1 Sizes CS2000AWF 4 R-S to CS2000AWF 6 R-S

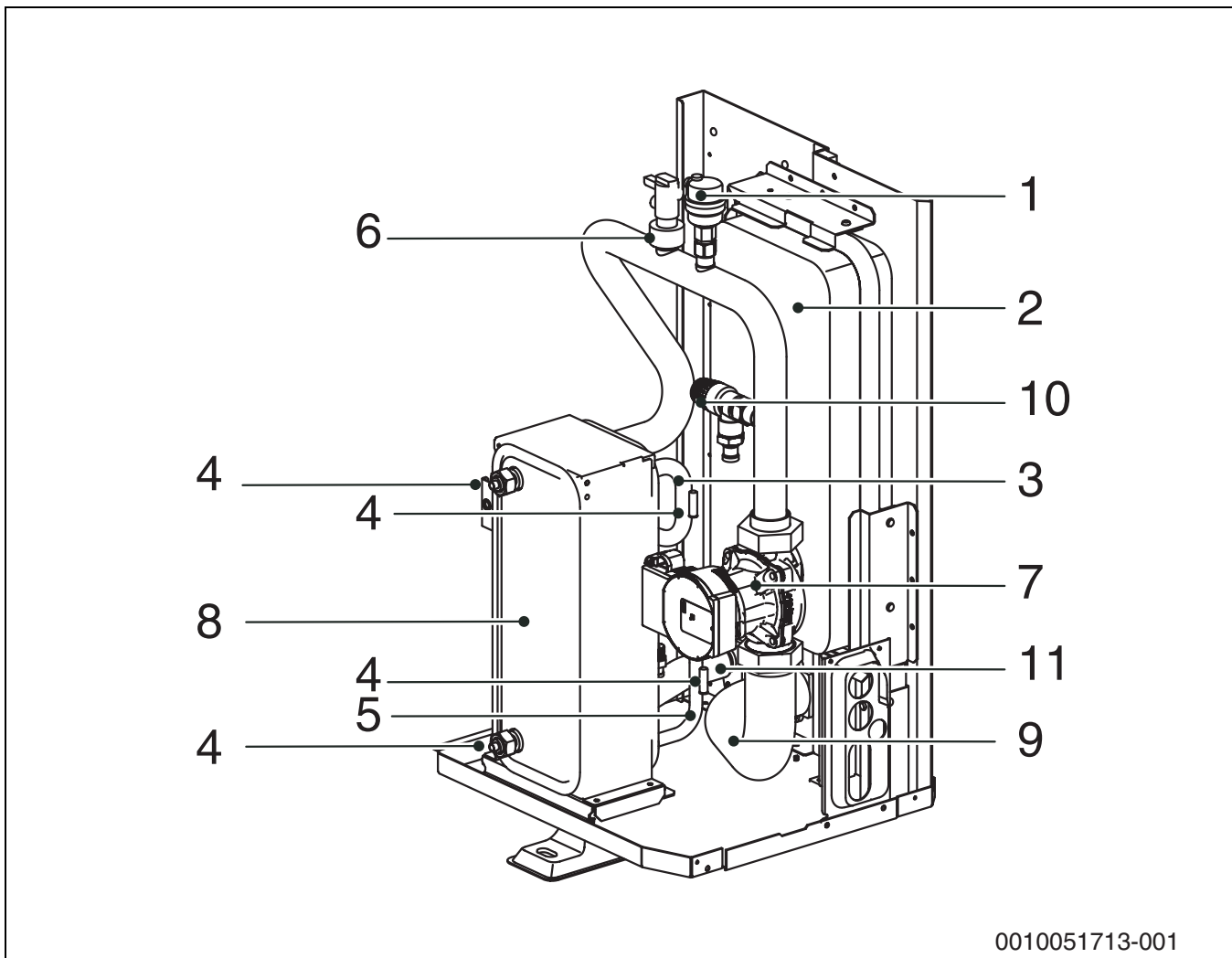

0010051713-001

Fig. 5 Sizes CS2000AWF 4 R-S to CS2000AWF 6 R-S

- [1] Automatic air vent valve
- [2] Expansion tank
- [3] Refrigerant gas pipe
- [4] Temperature sensors
- [5] Refrigerant pipe
- [6] Flow switch
- [7] Pump
- [8] Plate heat exchanger
- [9] Water outlet pipe
- [10] Pressure relief valve
- [11] Water inlet pipe

4.2.2 Sizes CS2000AWF 8 R-S to CS2000AWF 16 R-S/CS2000AWF 16 R-T

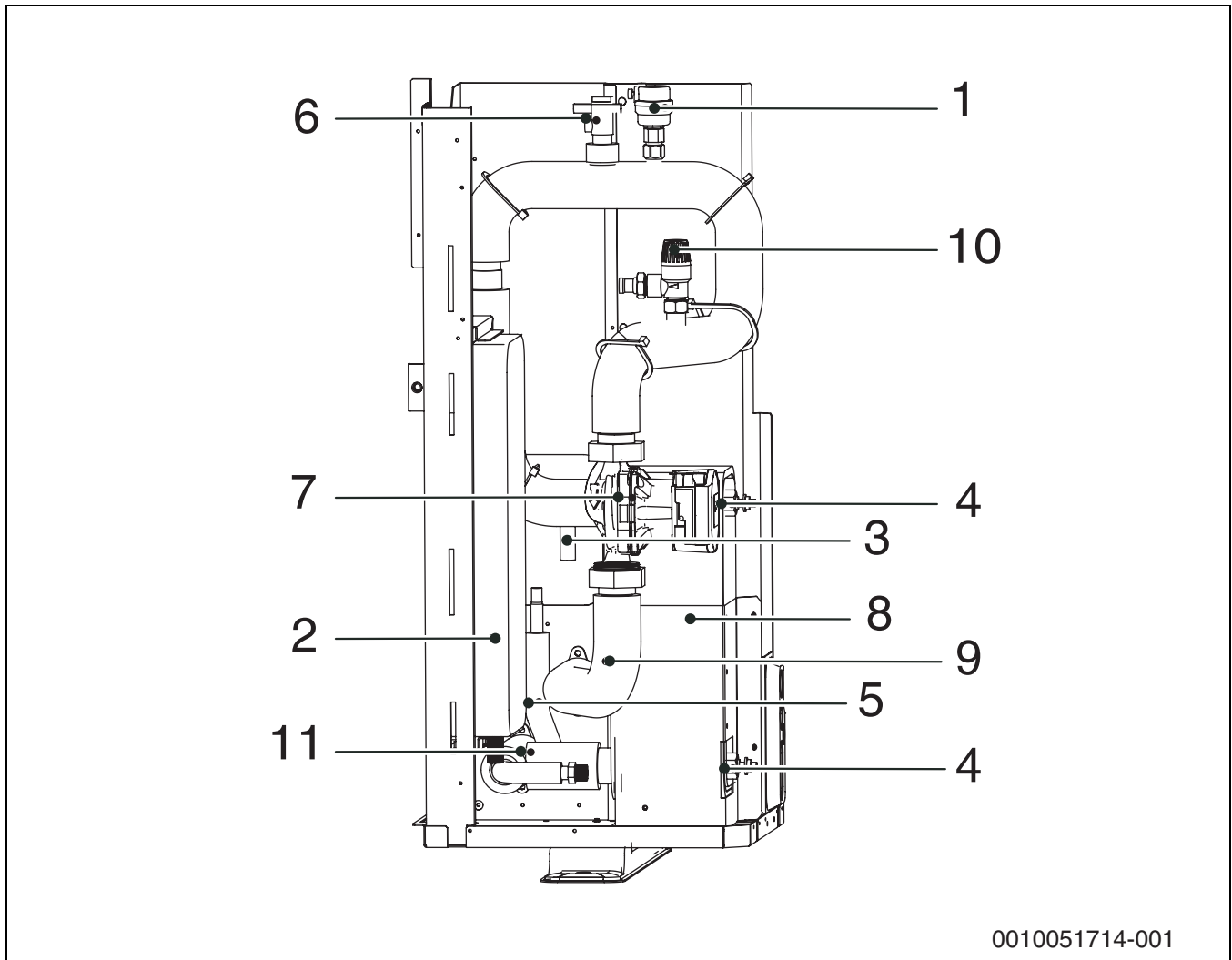

0010051714-001

Fig. 6 Sizes CS2000AWF 8 R-S to CS2000AWF 16 R-S/CS2000AWF 16 R-T

- [1] Automatic air vent valve
- [2] Expansion tank
- [3] Refrigerant gas pipe
- [4] Temperature sensors
- [5] Refrigerant pipe
- [6] Flow switch
- [7] Pump
- [8] Plate heat exchanger
- [9] Water outlet pipe
- [10] Pressure relief valve
- [11] Water inlet pipe

#### 4.2.3 Sizes CS2000AWF 18 R-T to CS2000AWF 30 R-T

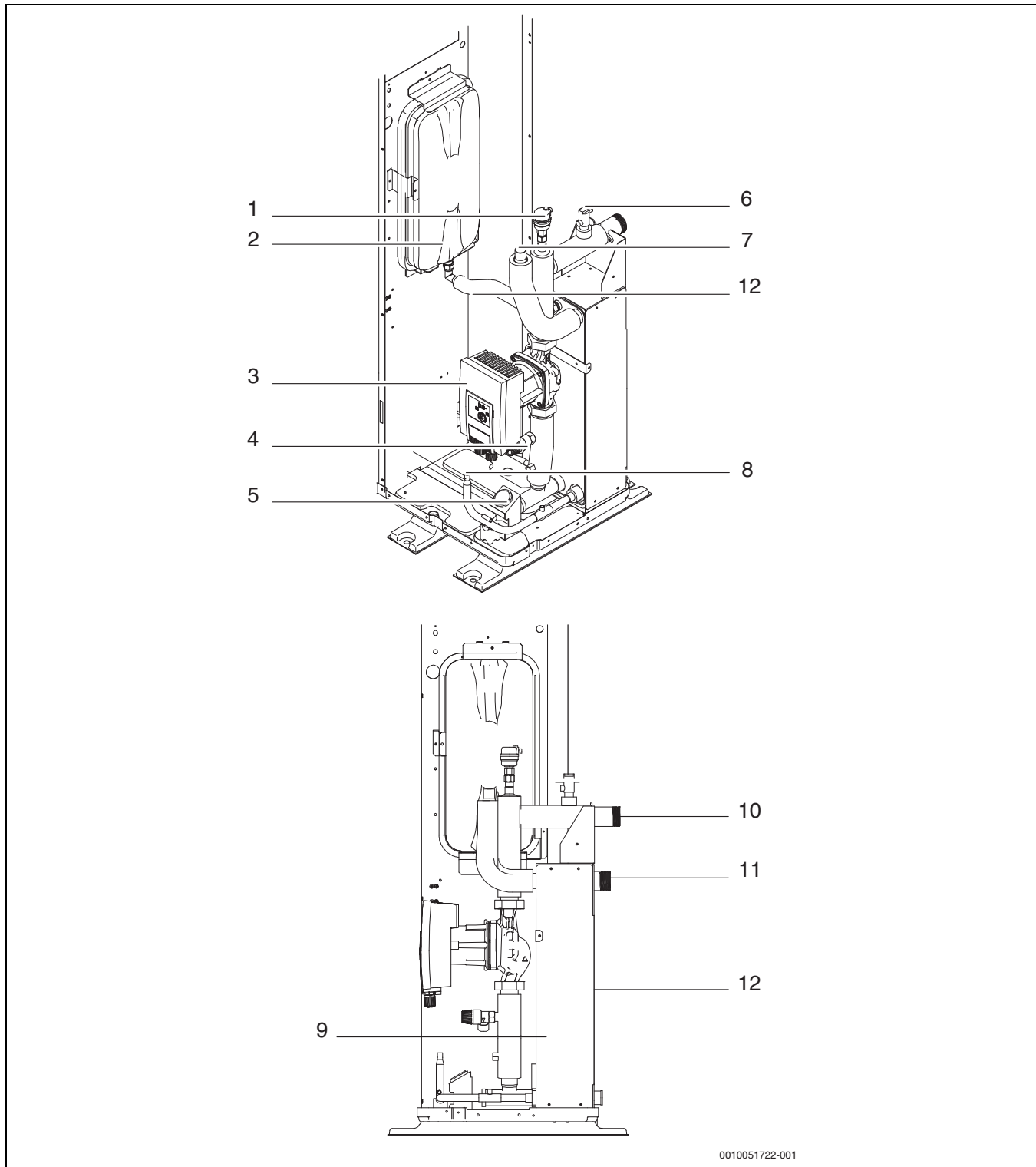

Fig. 7 Sizes CS2000AWF 18 R-T to CS2000AWF 30 R-T

- [1] Automatic air vent valve
- [2] Expansion tank
- [3] Circulation pump
- [4] Pressure relief valve
- [5] Pressure gauge
- [6] Flow switch
- [7] Refrigerant gas pipe
- [8] Refrigerant pipe
- [9] Plate heat exchanger
- [10] Water outlet pipe
- [11] Water inlet pipe
- [12] Electric heating tape

### 4.3 Technical data

#### 4.3.1 Technical specifications

	Unit	CS2000 AWF 4 R-S	CS2000 AWF 6 R-S	CS2000 AWF 8 R-S	CS2000 AWF 10 R-S	CS2000 AWF 12 R-S/T	CS2000 AWF 14 R-S/T	CS2000 AWF 16 R-S/T	CS2000 AWF 18 R-T	CS2000 AWF 22 R-T	CS2000 AWF 26 R-T	CS2000 AWF 30 R-T
<b>Rating according to EN 14511</b>												
Power output with A -7/W35, 100% compressor speed	kW	4.99	6.21	7.27	8.31	11.00	12.70	13.90	19.91	21.28	23.46	23.26
Power output with A -7/W35, rated output	kW	4.70	6.00	7.00	8.00	10.00	12.00	13.1	18.0	21.00	22.00	23.00
COP with A -7/W35, rated output		3.10	3.00	3.20	30.5	3.00	2.85	2.70	2.70	2.60	2.50	2.45
Power output with A +2/W35, 100% compressor speed	kW	5.33	6.56	8.71	9.78	12.64	13.16	15.02	20.23	23.24	25.44	26.02
Power output with A +2/W35, rated output	kW	4.40	5.50	7.10	8.20	9.20	11.00	13.00	18.00	22.00	24.00	26.00
COP with A +2/W35, rated output		4.00	3.90	4.10	4.00	3.90	3.60	3.45	3.38	3.10	2.88	2.80
Power output with A +7/W35, 100% compressor speed	kW	6.26	7.41	9.11	10.30	14.60	15.50	16.80	20.74	24.93	29.08	31.75
Power output with A +7/W35, rated output	kW	4.20	6.35	8.40	10.00	12.10	14.50	15.90	18.00	22.00	26.00	30.10
COP with A +7/W35, rated output		5.10	4.95	5.15	4.95	4.95	4.60	4.50	4.70	4.40	40.8	3.91
Cooling capacity with A 35/W7, rated output	kW	4.70	7.00	7.45	8.20	11.50	12.40	14.00	17.00	21.00	26.00	29.5
EER with A 35/W7, rated output		3.45	3.00	3.35	3.25	2.75	2.50	2.50	3.05	2.95	2.70	2.55
Cooling capacity with A 35/W18, rated output	kW	4.50	6.50	8.30	9.90	12.00	13.50	14.20	18.50	23.00	27.00	31.00
EER with A 35/W18, rated output		5.50	4.80	5.05	4.55	3.95	3.61	3.61	4.75	4.60	4.30	4.00
<b>Performance data according to EN 14825</b>												
SCOP for low temperature heating system (35 °C), average climate		4.85	4.95	5.22	5.20	4.81	4.72	4.62	4.60	4.53	4.5	4.2
Seasonal energy efficiency of the room heating ( $\eta_s$ ) for low temperature heating system (35 °C), average climate	%	191	195	205	205	189	186	182	181	179	177	165
SCOP for average temperature heating system (55 °C), average climate		3.31	3.52	3.37	3.47	3.45	3.47	3.41	3.20	3.23	3.15	3.15
Seasonal energy efficiency of the room heating ( $\eta_s$ ) for average temperature heating system (55 °C), average climate	%	129	138	131	137	135	135	133	125	126	123	123

Table 5 Technical specifications - heat pump

	Unit	CS20 00AW F 4 R-S	CS20 00AW F 6 R-S	CS20 00AW F 8 R-S	CS20 00AW F 10 R-S	CS20 00AW F 12 R-S	CS20 00AW F 14 R-S	CS20 00AW F 16 R-S	CS20 00AW F 12 R-T	CS20 00AW F 14 R-T	CS20 00AW F 16 R-T	CS20 00AW F 18 R-T	CS20 00AW F 22 R-T	CS20 00AW F 26 R-T	CS20 00AW F 30 R-T
<b>Electrical details</b>															
Power supply		230 V 1 N AC 50 Hz						400 V 3 N AC, 50 Hz							
IP rating		IP24													
Fuse rating for supplying the heat pump directly via the building connection <sup>1)</sup>	A	18	18	19	19	30	14	30	14	30	14	18	21	24	28

	Unit	CS20 00AW F 4 R-S	CS20 00AW F 6 R-S	CS20 00AW F 8 R-S	CS20 00AW F 10 R-S	CS20 00AW F 12 R-S	CS20 00AW F 14 R-S	CS20 00AW F 16 R-S	CS20 00AW F 12 R-T	CS20 00AW F 14 R-T	CS20 00AW F 16 R-T	CS20 00AW F 18 R-T	CS20 00AW F 22 R-T	CS20 00AW F 26 R-T	CS20 00AW F 30 R-T	
Maximum power consumption	kW	2.3	2.7	3.4	3.7	5.5	5.8	6.2	5.5	5.8	6.2	10.6	12.5	13.8	14.5	
Heat pump soft start		Yes														
Soft start type		Inverter														
<b>Air and noise generation</b>																
Sound pressure level at a distance of 1 m	dB(A)	41	44	45	46	50	50	50	50	53	53	50	50	53	55	
Sound Power <sup>2)</sup>	dB(A)	55	58	59	60	65	65	65	65	68	68	65	65	68	70	
<b>General details</b>																
Refrigerant <sup>3)</sup>		R32														
Refrigerant charge	kg	1.40	1.40	1.40	1.40	1.75	1.75	1.75	1.75	1.75	1.75	5.00	5.00	5.00	5.00	
CO <sub>2</sub> (e)	Tonne	945	945	945	945	1181	1181	1181	1181	1181	1181	3375	3375	3375	3375	
Minimum water flow rate	l/s	0.11	0.11	0.11	0.11	0.20	0.20	0.20	0.20	0.20	0.20	0.50	0.50	0.50	0.50	
Installation altitude above sea level		Up to 2000 m above sea level														
Dimensions (W x H x D)	mm	1295x717x42 6			1385x864x523						1120x1557x528					
Weight	kg	86	86	105	105	129	129	129	144	144	144	177	177	177	177	

1) Fuse class gL/C

2) Sound power level according to EN 12102

3) GWP100 = 675

Table 6 Technical specifications - heat pump

#### 4.3.2 Operating range

##### Ambient temperature ranges

Models CS2000AWF 4 R-S ~ CS2000AWF 16 R-S/ CS2000AWF 16 R-T cooling mode	-5 °C to 43 °C
Models CS2000AWF 18 R-T ~CS2000AWF 30 R-T cooling mode	-5 °C to 46 °C
Heating mode	-25 °C to 35 °C
DHW production	-25 °C to 43 °C

Table 7 Units according to ambient temperature ranges



In the case of larger distances, contact the supplier for information on possible risks and suggestions to limit them.

#### Heating / DHW

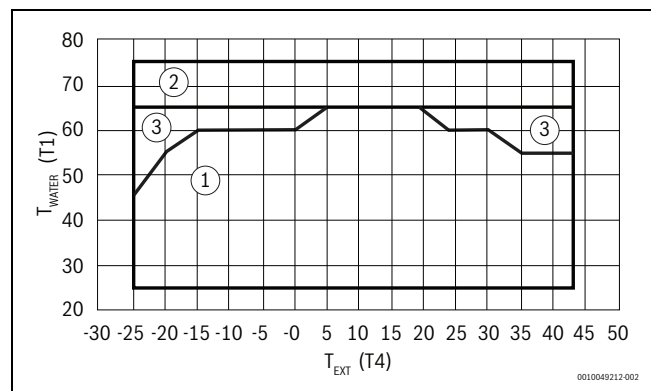

Fig. 8 CS2000AWF 4-6 R-S, CS2000AWF 8-10 R-S, CS2000AWF 12-16 R-S/T

- [1] Heating / DHW in heat pump only
- [2] Back-up / additional with boiler
- [3] Back-up / additional with electric heater

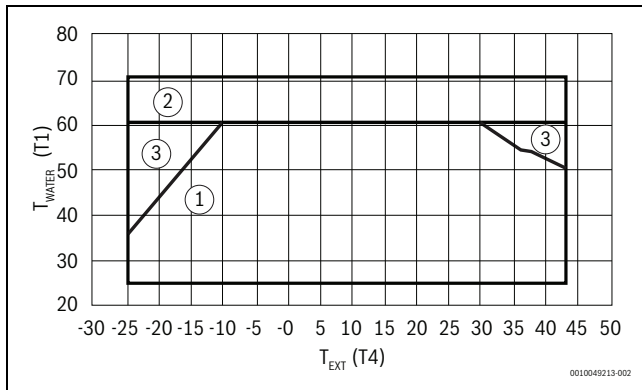

Fig. 9 CS2000AWF 18-30 R-T

- [1] Heating / DHW in heat pump only
- [2] Back-up / additional with boiler
- [3] Back-up / additional with electric heater

**Cooling**

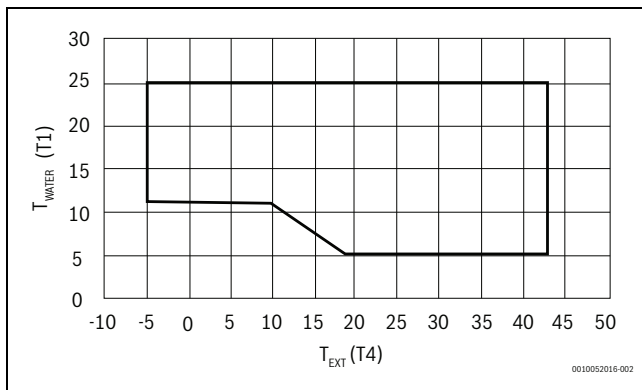

Fig. 10 CS2000AWF 4-6 R-S, CS2000AWF 8-10 R-S, CS2000AWF 12-16 R-S/T

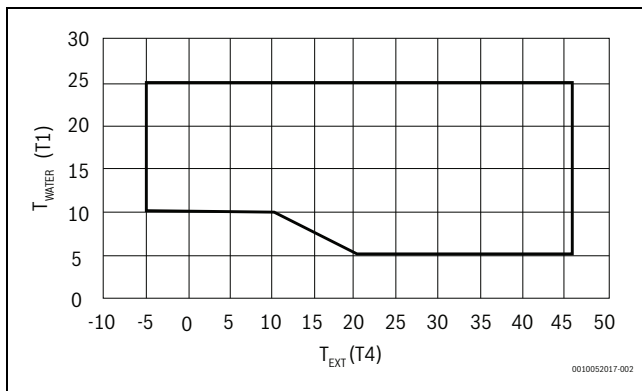

Fig. 11 CS2000AWF 18-30 R-T

**Maximum temperatures of components not supplied**

System	75 °C
DHW	95 °C

Table 8 Maximum temperatures of components not supplied

**4.3.3 Capacity curve of the circulation pump**

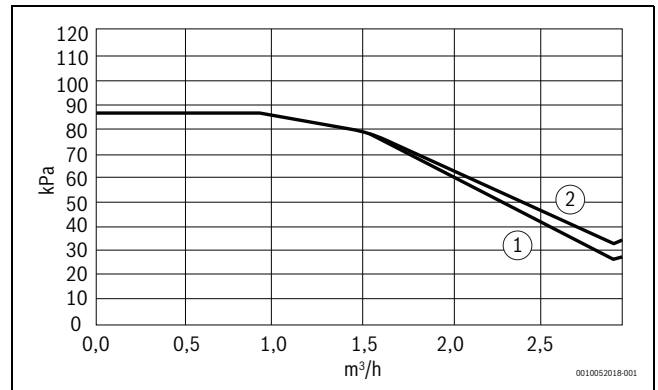

Fig. 12 CS2000AWF 4-6 R-S

- [1] CS2000AWF 4-6 R-S, CS2000AWF 8-10 R-S
- [2] CS2000AWF 12-16 R-S/T

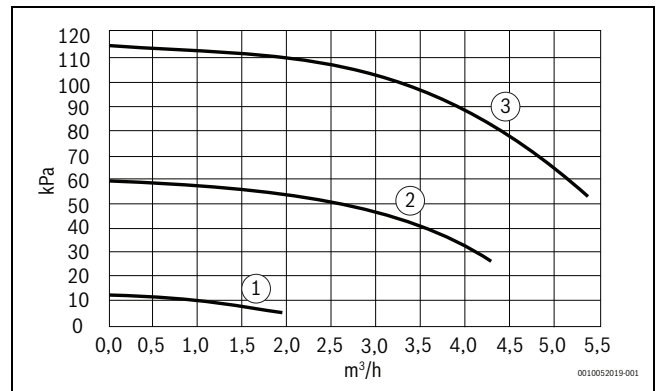

Fig. 13 CS2000AWF 18-30 R-T

- [1] Min
- [2] Mid
- [3] Max

#### 4.3.4 System solutions

Some system configurations require accessories (buffer cylinder, 3-way valve, mixing valve, DHW circulation pump).



The outdoor unit and the indoor unit may only be installed according to the manufacturer's official system solutions.

Deviating system solutions are impermissible. Warranty may be voided in the case of damage and problems resulting from impermissible installation.

#### System with heating circuit, electric backup heater, DHW and solar

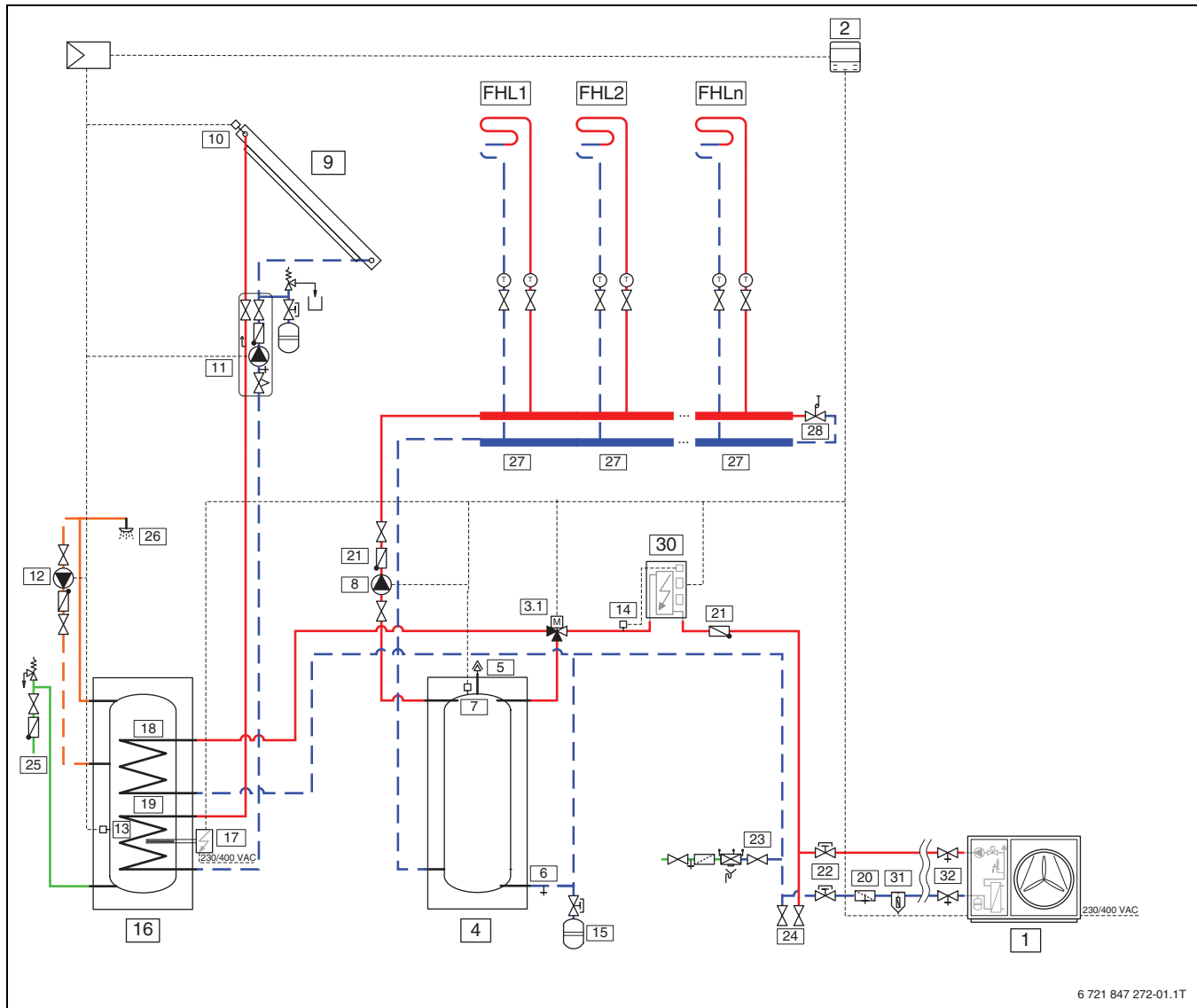
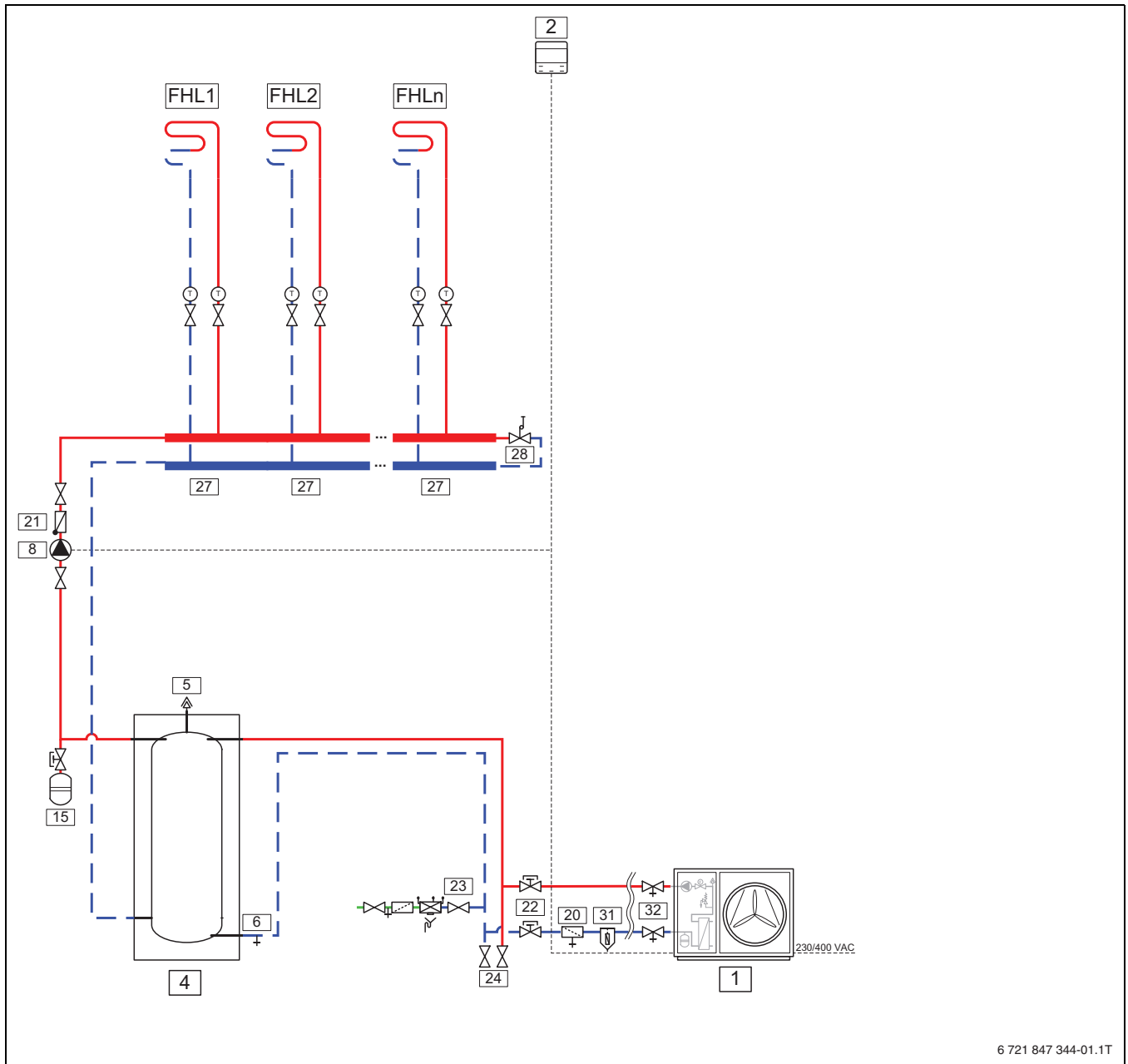

Fig. 14 Outdoor unit with one or many heating circuits, electric backup heater, DHW tank and solar (CS2000AWF 4-6 R-S, CS2000AWF 8-10 R-S, CS2000AWF 12-16 R-S/T)

**System with heating circuit**



6 721 847 344-01.1T

Fig. 15 Outdoor unit with one or many heating circuits (CS2000AWF 4-6 R-S, CS2000AWF 8-10 R-S, CS2000AWF 12-16 R-S/T)

**System with heating circuit with underfloor heating and fan coil (mode set)**

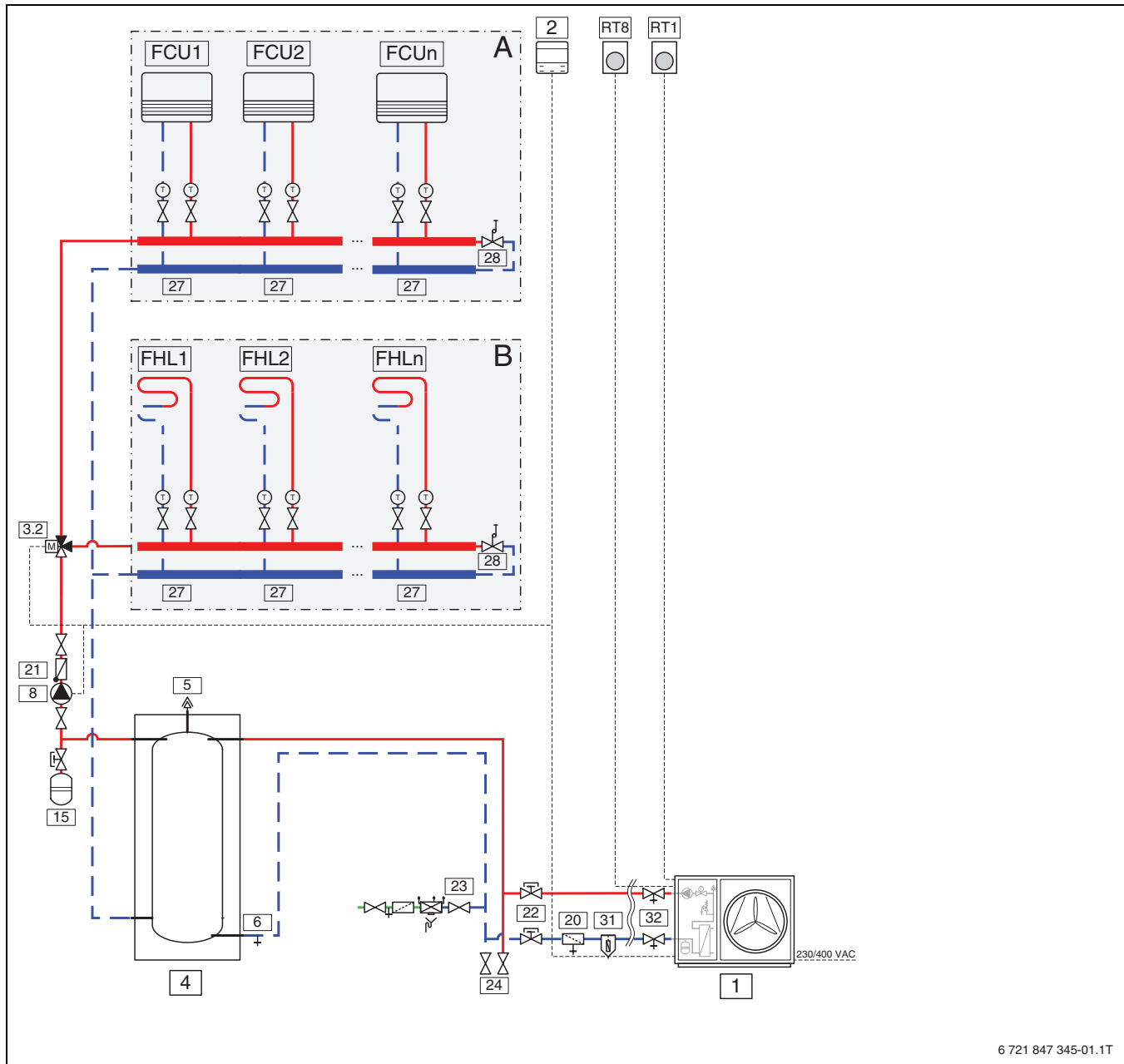

6 721 847 345-01.1T

Fig. 16 Outdoor unit with one or many heating circuits, underfloor heating and fan coil (CS2000AWF 4-6 R-S, CS2000AWF 8-10 R-S, CS2000AWF 12-16 R-S/T)

**System with heating circuit, underfloor heating and radiators (double zone)**

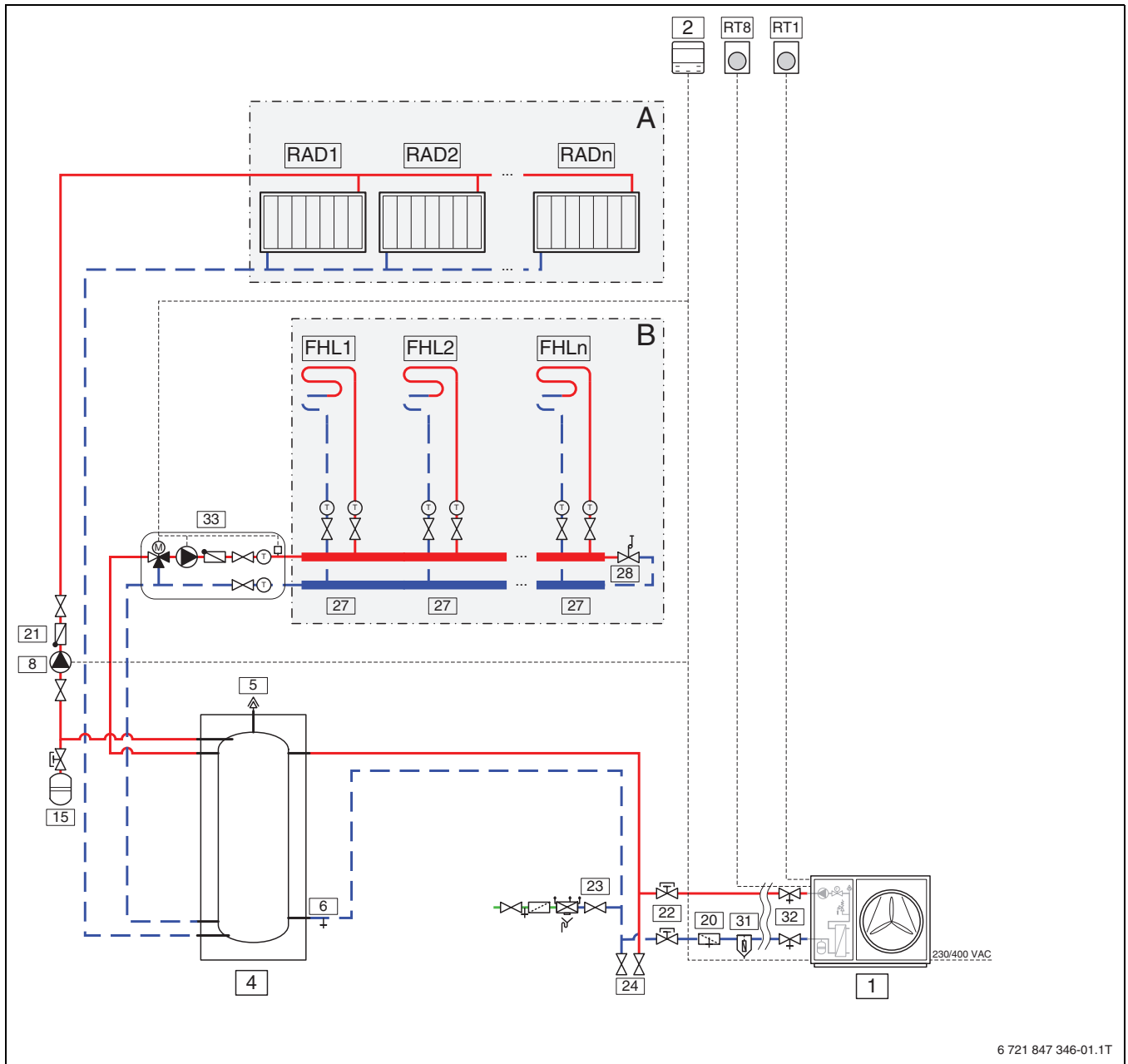

6 721 847 346-01.1T

Fig. 17 Outdoor unit with one or many heating circuits, underfloor heating and radiators (CS2000AWF 4-6 R-S, CS2000AWF 8-10 R-S, CS2000AWF 12-16 R-S/T)

**System with heating circuit**

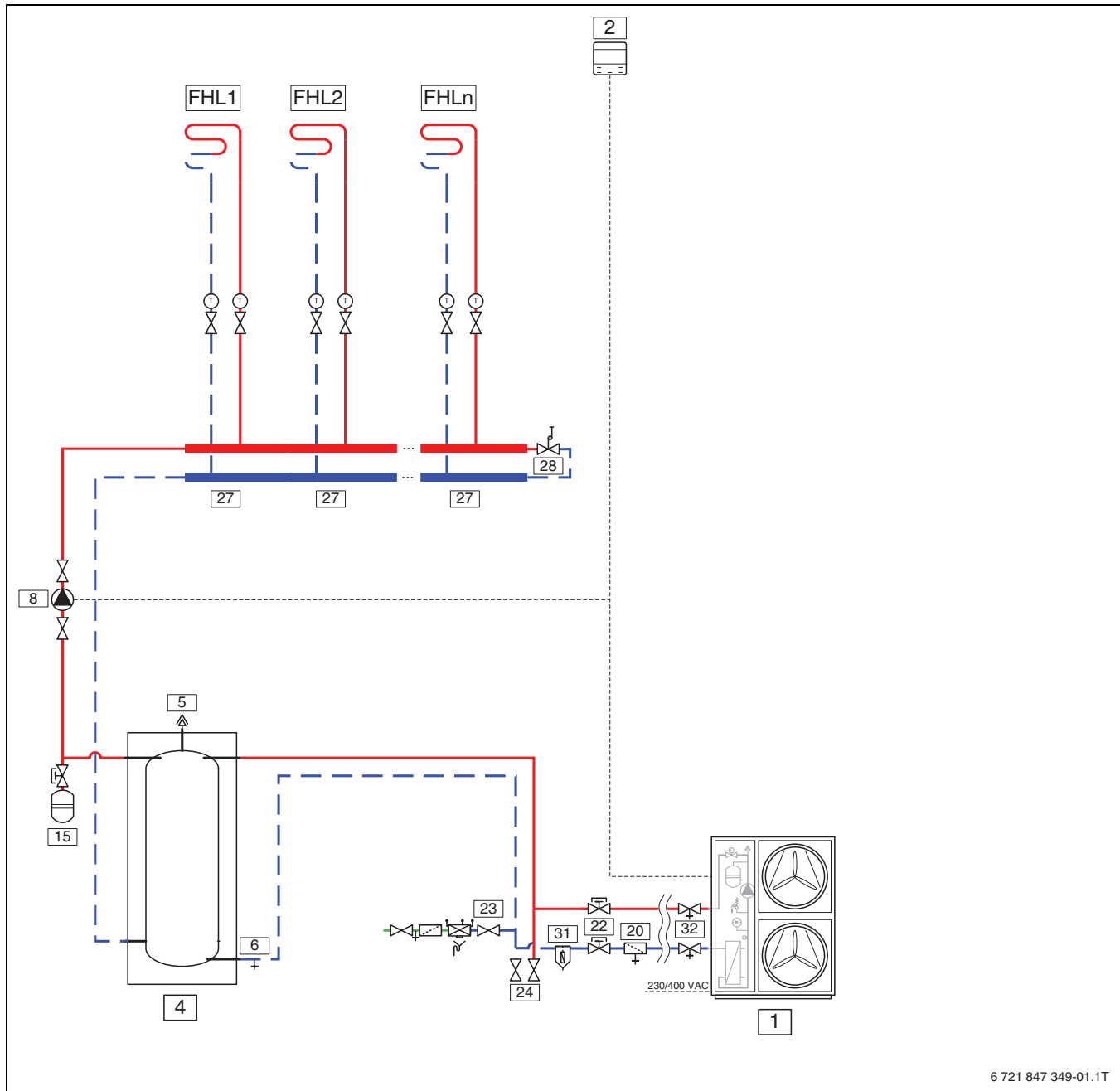

6 721 847 349-01.1T

Fig. 18 Outdoor unit with one or many heating circuits (CS2000AWF 18-30 R-T)

**System with heating circuit, DHW and solar**

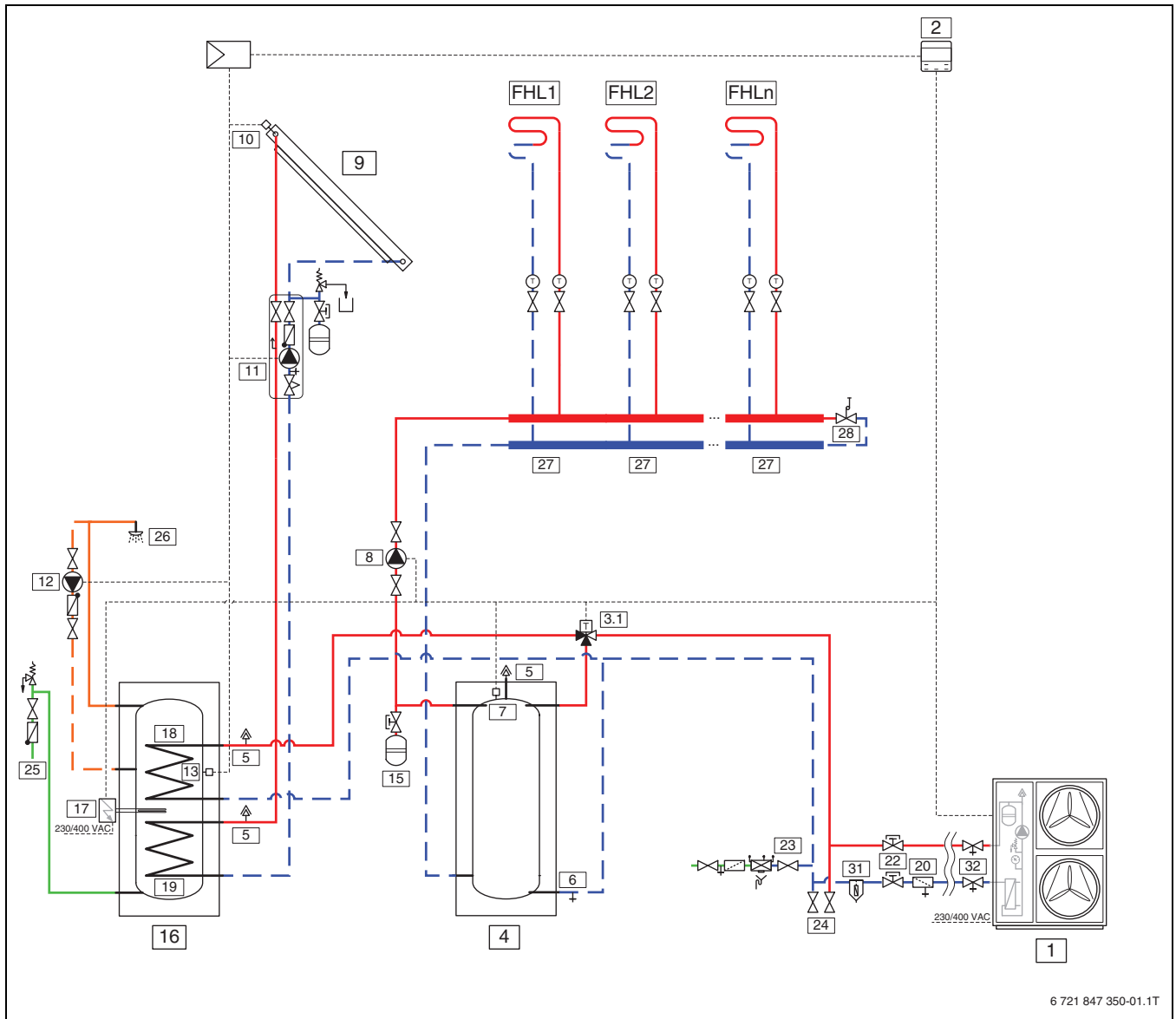
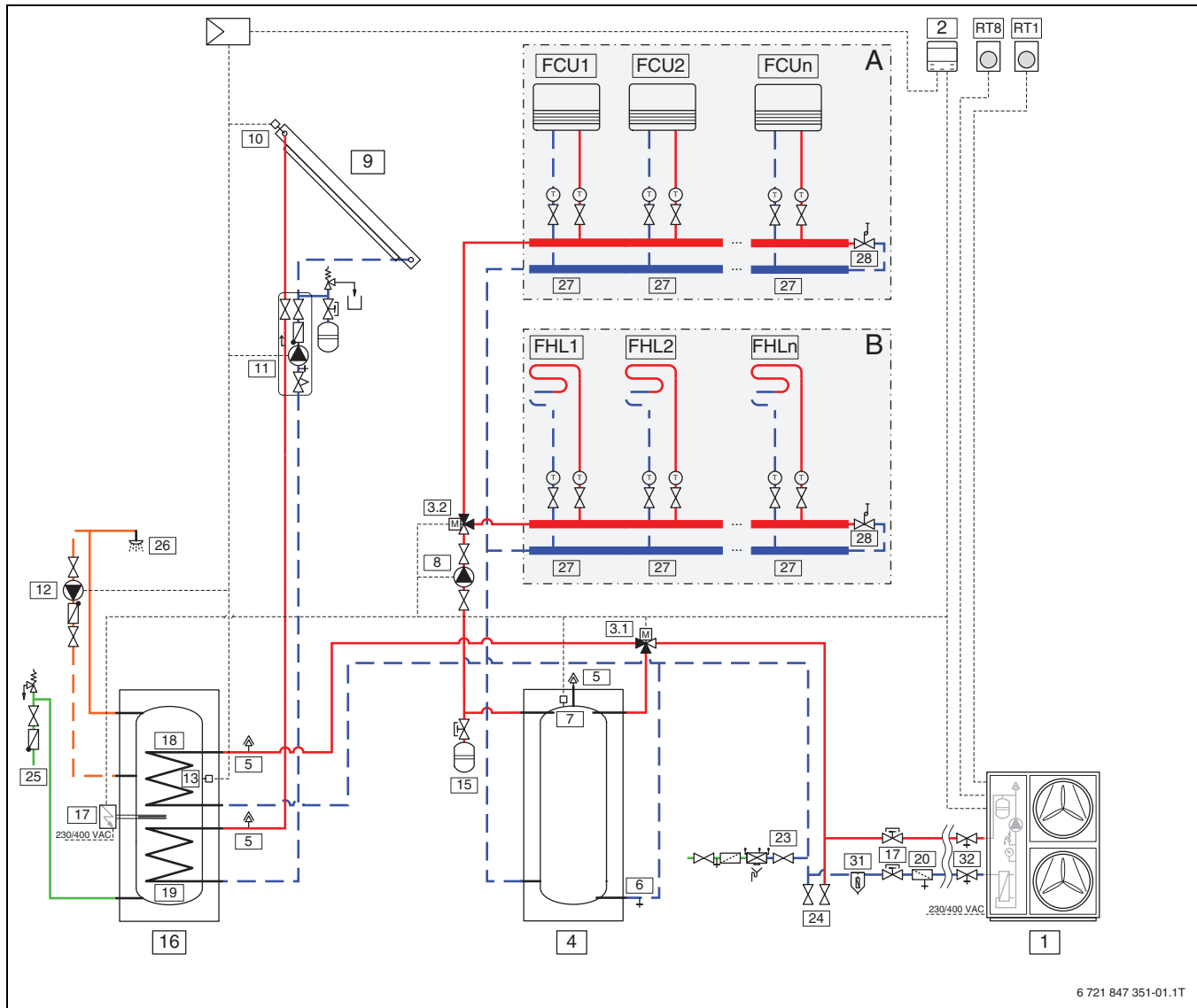

Fig. 19 Outdoor unit with on or many heating circuits, DHW tank and solar (CS2000AWF 18-30 R-T)

6 721 847 350-01.1T

**System with heating circuit, electric backup heater, DHW and solar (mode set)**



6 721 847 351-01.1T

Fig. 20 Outdoor unit with one or many heating circuits, electric backup heater, DHW tank and solar (CS2000AWF 18-30 R-T)

**System with heating circuit, external auxiliary heater, DHW and solar**

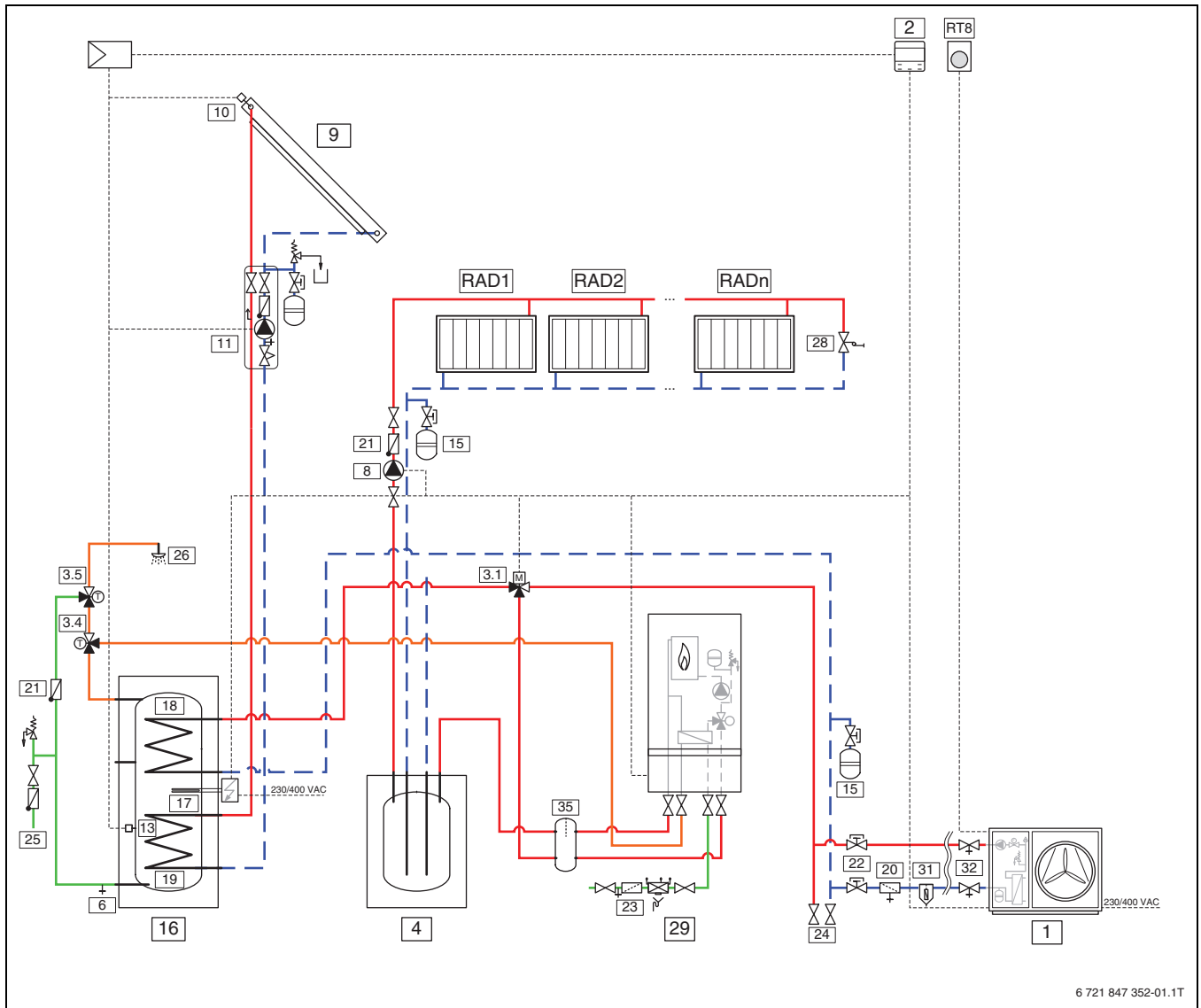

6 721 847 352-01.1T

Fig. 21 Outdoor unit with one or many heating circuits, external auxiliary heater, DHW tank and solar (CS2000AWF 4-6 R-S, CS2000AWF 8-10 R-S, CS2000AWF 12-16 R-S/T)

**System with heating circuit, external auxiliary heater and DHW**

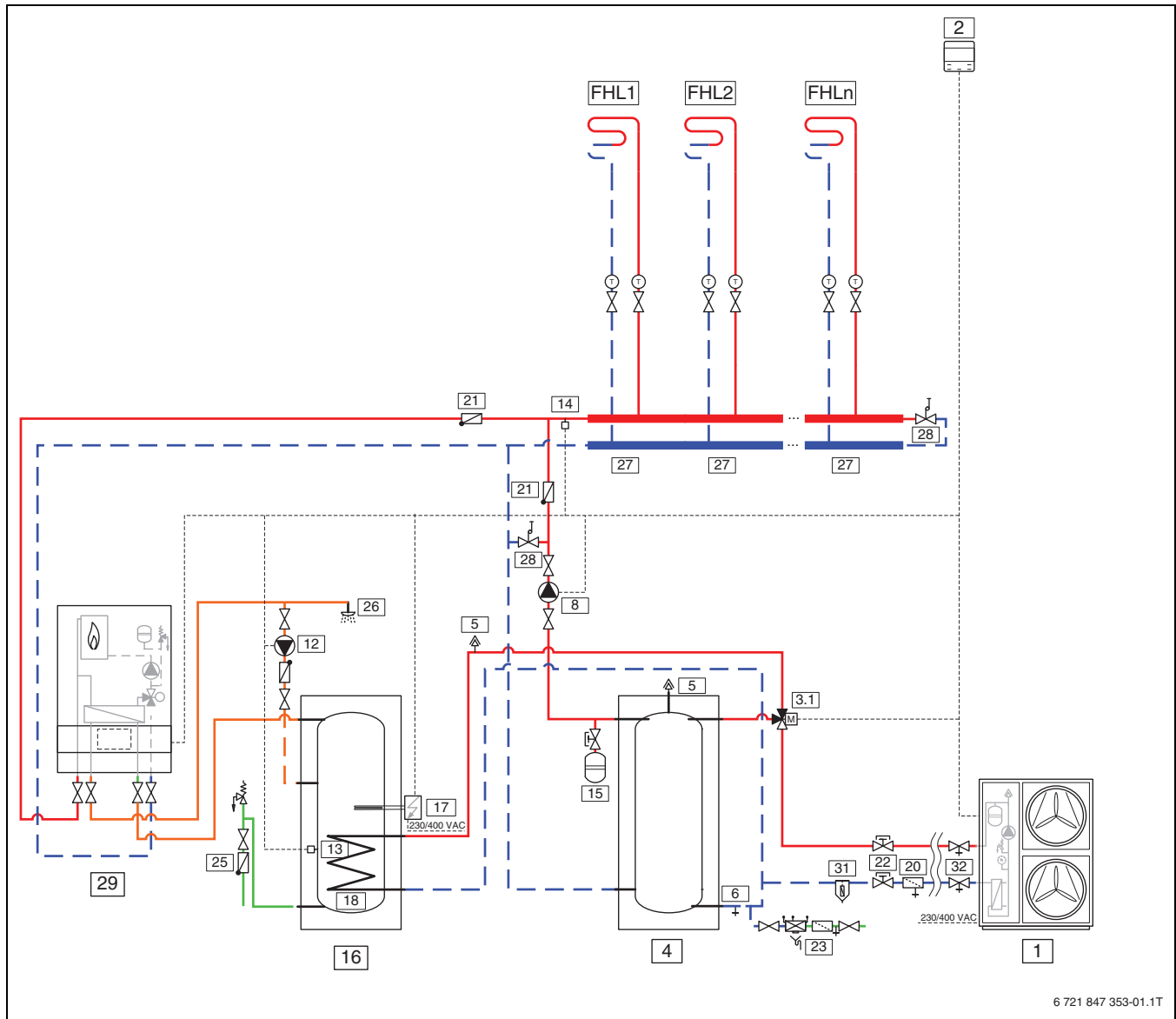

6 721 847 353-01.1T

Fig. 22 Outdoor unit with one or many heating circuits, external auxiliary heater and DHW tank (CS2000AWF 18-30 R-T)

**System with heating circuit, external auxiliary heater and DHW**

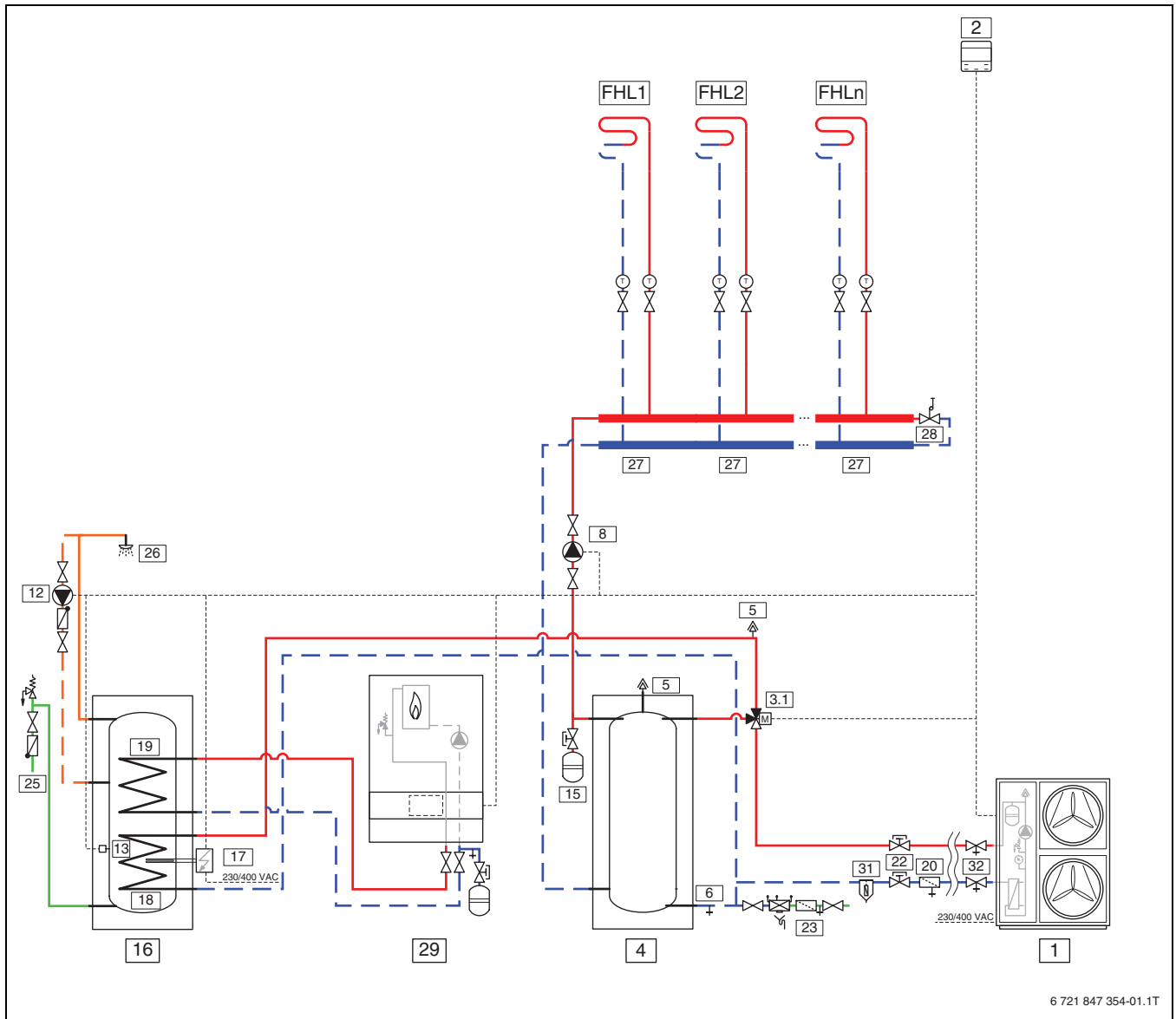

6 721 847 354-01.1T

Fig. 23 Outdoor unit with one or many heating circuits, external auxiliary heater and DHW tank (CS2000AWF 18-30 R-T)

**System with heating circuit, underfloor heating and radiators (double zone)**

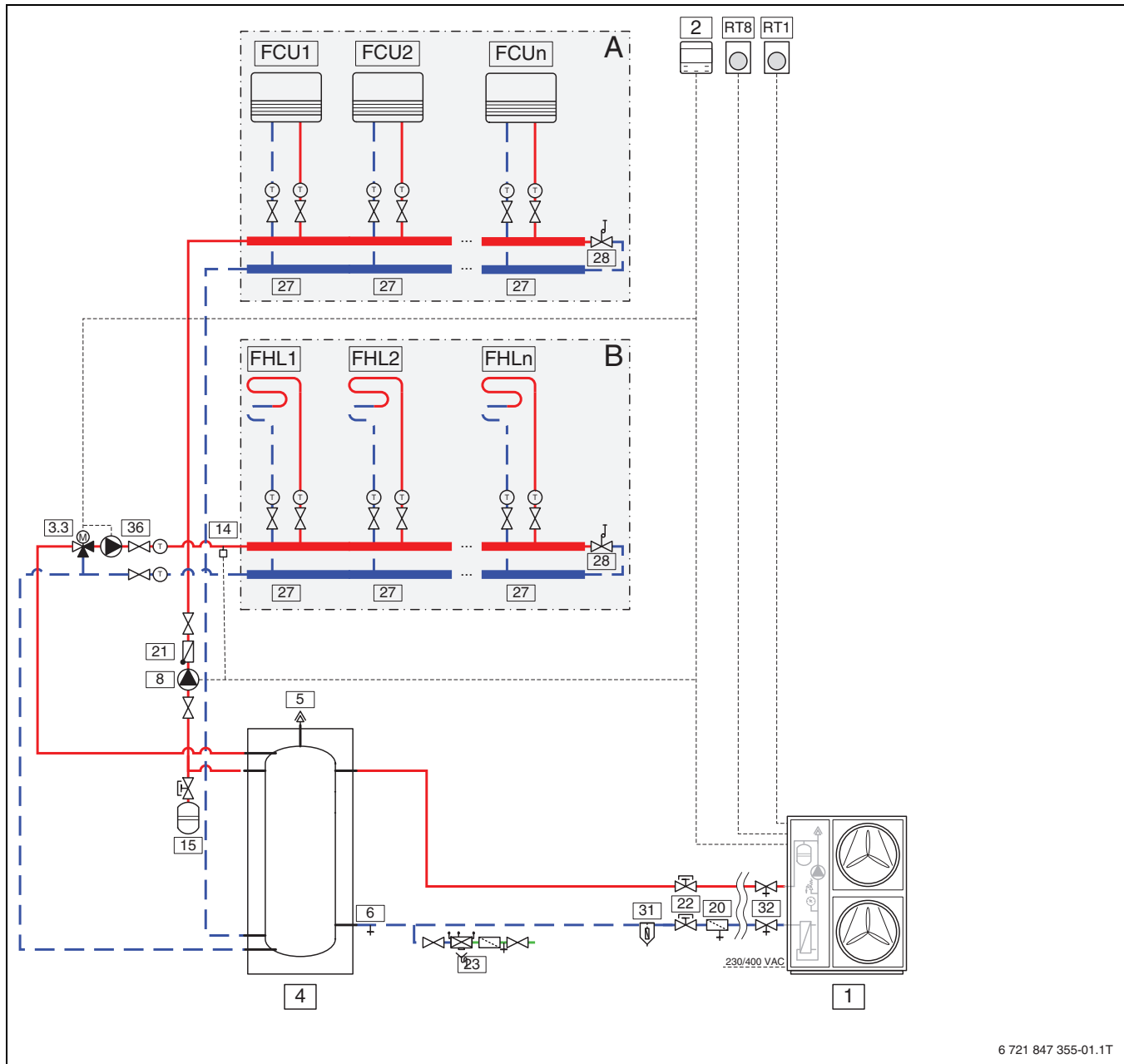

6 721 847 355-01.1T

Fig. 24 Outdoor unit with one or many heating circuits, underfloor heating and radiators (CS2000AWF 18 -30 R-T)

**System with heating circuit and external auxiliary heater**

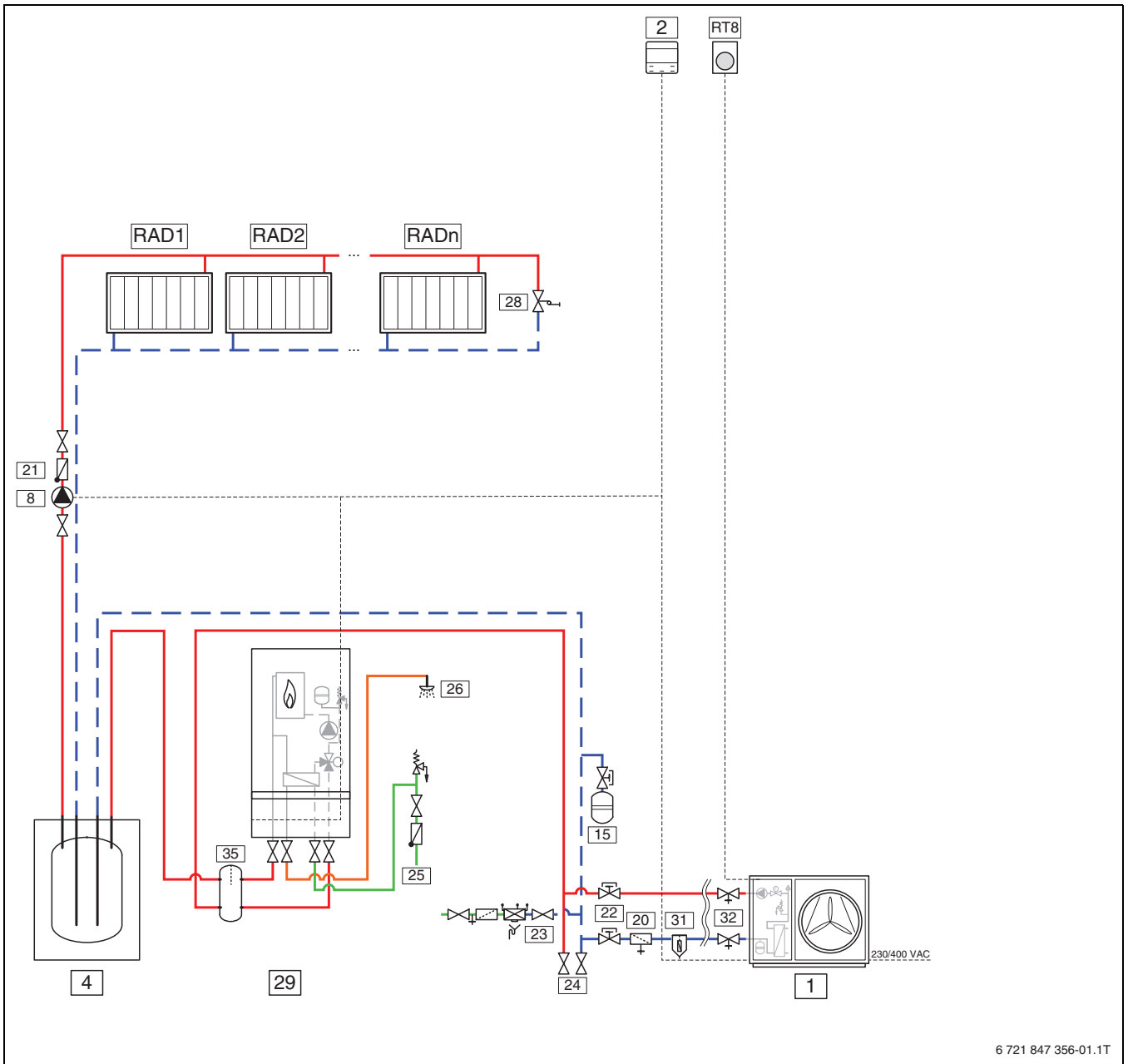

6 721 847 356-01.1T

Fig. 25 Outdoor unit with one or many heating circuits and external auxiliary heater (CS2000AWF 4-6 R-S, CS2000AWF 8-10 R-S, CS2000AWF 12-16 R-S/T)

**System with heating circuit, external auxiliary heater, DHW and cascading (double zone)**

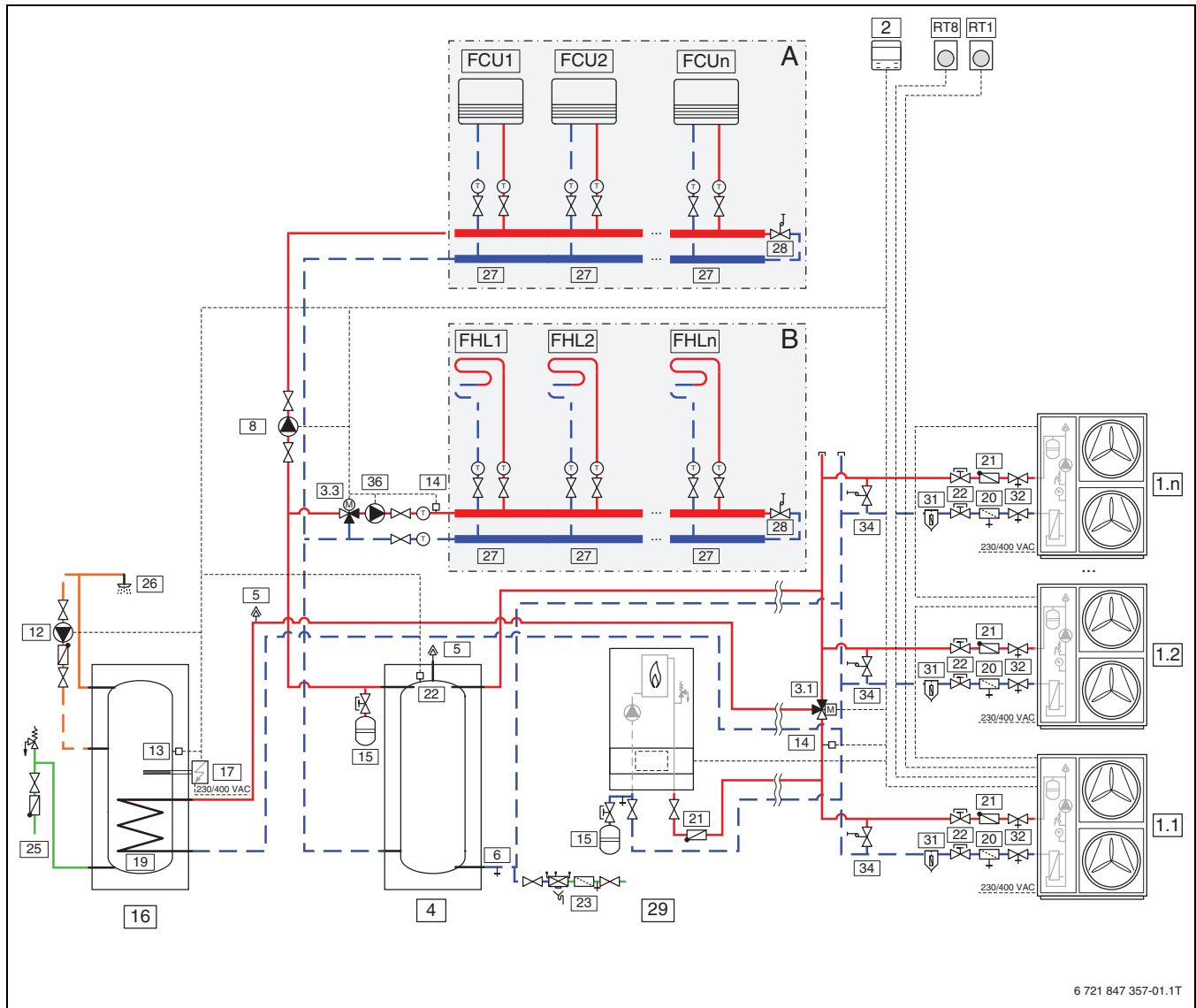

Fig. 26 Outdoor unit with one or many heating circuits, external auxiliary heater, DHW tank and cascading (CS2000AWF 18 -30 R-T)

en	Legend
[1]	Outdoor unit
[2]	User interface
[3.1]	SV1: 3-way switching valve (directs to DHW/central heating) <sup>1)</sup>
[3.2]	SV2: 3-way switching valve (directs to heating circuits 1/2) <sup>1)</sup>
[3.3]	SV3: 3-way mixing valve <sup>1)</sup>
[3.4]	3-way mixing valve (changeover) <sup>1)</sup>
[3.5]	DHW mixer (thermostatic) <sup>1)</sup>
[4]	Buffer tank <sup>1)</sup>
[5]	Purger <sup>1)</sup>
[6]	Drainage valve <sup>1)</sup>
[7]	Tbt1: Buffer tank upper temperature sensor <sup>1)</sup>
[8]	P_o: Circulation pump zone 1 <sup>1)</sup>
[9]	Solar panel <sup>1)</sup>
[10]	Tsolar: Solar temperature sensor <sup>1)</sup>
[11]	P_s: Solar pump <sup>1)</sup>
[12]	P_d: DHW pipe pump <sup>1)</sup>
[13]	T5: DHW tank temperature sensor <sup>1)</sup>
[14]	T1: Water flow temperature sensor
[15]	Expansion vessel <sup>1)</sup>
[16]	DHW tank <sup>1)</sup>
[17]	TBH: DHW tank electric auxiliary heater <sup>1)</sup>
[18]	Coil 1: heat exchanger heat pump <sup>1)</sup>
[19]	Coil 2: heat exchanger solar / external auxiliary heater <sup>1)</sup>
[20]	Filter
[21]	Check valve <sup>1)</sup>
[22]	Shut-off valve <sup>1)</sup>
[23]	Filling valve <sup>1)</sup>
[24]	Drainage valve <sup>1)</sup>
[25]	Tap water inlet pipe <sup>1)</sup>
[26]	Hot water tap <sup>1)</sup>
[27]	Collector/distributor <sup>1)</sup>
[28]	Bypass valve <sup>1)</sup>
[29]	AHS: External auxiliary heater <sup>1)</sup>
[30]	IBH: Electric Backup heater <sup>1)</sup>
[31]	Magnetite filter <sup>1)</sup>
[32]	Anti-freeze valve <sup>1)</sup>
[33]	Hydraulic kit for double zone <sup>1)</sup>
[34]	Differential pressure control valve <sup>1)</sup>
[35]	Low-loss header <sup>1)</sup>
[36]	P_c: Circulation pump zone 2 <sup>1)</sup>
[FHL]	Floor heating loop (no. 1...n) <sup>1)</sup>
[FCU]	Fan coil unit (no. 1...n) <sup>1)</sup>
[RAD]	Radiator (no. 1...n) <sup>1)</sup>
[RT1]	Low voltage room thermostat <sup>1)</sup>
[RT8]	High voltage room thermostat <sup>1)</sup>

1) Field supply

#### 4.3.5 Explanation of symbols



























































Symbol	Description	Symbol	Description	Symbol	Description
<b>Pipework/cables</b>					
	Flow - heating/solar		Brine circuit out		DHW circulation
	Return - heating/solar		Potable water		Electrical Wiring
	Brine flow		Hot water		Electrical wiring with break
<b>Mixing valves/valves/temperature sensors/pumps</b>					
	Valve		Differential pressure regulator		Pump
	Revision bypass		Water pressure relief valve		Non-return valve
	Flow regulating valve		Safety assembly		Temperature sensor / switch
	Overcurrent valve		3-way mixing valve (mixing/distribution)		High limit safety cut-out
	Filter shut-off valve		DHW mixer, thermostatic		Flue gas temperature sensor / switch
	Cap valve		3-way mixing valve (changeover)		Flue gas temperature limiter
	Valve, motorized		3-way mixing valve (change over, de-energised when closed to II)		Outdoor ambient temperature sensor
	Valve, thermal		3-way mixing valve (change over, de-energised when closed to A)		Wireless outside temperature sensor
	Shut-off valve, magnetically controlled		4-way mixing valve		...wireless...
<b>Miscellaneous</b>					
	Thermometer		Drain outlet with siphon		Low loss header with sensor
	Pressure gauge		System separation according to EN1717		heat exchanger
	Filling/draining		Expansion vessel with cap valve		Volumetric flow rate measuring device
	Water filter		Magnetite separator		Water sink
	Heat meter		Air separator		Heat. circ.
	DHW outlet		Automatic air vent valve		Underfloor heating circuit
	Relay		Expansion joint		Low-loss header
	Immersion heater				

Table 9 Hydraulic symbols

## 5 Before installation

### 5.1 Warnings

#### NOTICE

#### Risk of damaging the product!

- ▶ The indoor unit must not be installed in areas where it is exposed to water splashes.
- ▶ Do not install the indoor unit in bathrooms or exterior areas.



#### WARNING

#### Strong magnet!

Can be harmful to pacemaker wearers.

- ▶ Do not clean the filter or check the magnetite indicator if you are a pacemaker wearer.



Follow the instructions:

- ▶ The drain pipe of the pressure relief valve in the indoor unit must be installed so that it is protected against frost and the drain pipe must be routed to the drain.
- ▶ Run the connector pipes for the heating system and cold/domestic hot water in the building up to the installation location of the indoor unit.

### 5.2 Reception

It is important to check before accepting the delivery:

- If the unit hasn't been damaged during the transport.
- If the materials delivered correspond with that indicated on the transport document, comparing the data with the identification label positioned on the packaging.

In case of damage or anomaly identified:

- ▶ Write down on the transport document the damage found and quote this sentence: "Conditional acceptance clear evidence of deficiencies/damages during transport".
- ▶ Contact the supplier and the carrier through registered mail with advice of receipt.



Any disputes must be made within 8 days from the date of the delivery. Complaints after this period are invalid.

### 5.3 Storage

Respect the indications on the outside of the packaging, in particular:

- Minimum ambient temperature -30°C (possible components damages)
- Maximum room temperature +48°C (possible safety valve opening)
- Maximum relative humidity 95% (possible damages to electrical components)



Any disputes must be made within 8 days from the date of the delivery. Complaints after this period are invalid.

### 5.4 Handling

- ▶ Check if all the handling equipment complies with local safety regulations (crane, forklifts, ropes, hooks, etc.).

- ▶ Provide personnel with individual protective equipment suitable for the situation, such as the helmet, gloves accident prevention shoes, etc.
- ▶ Observe all safety procedures in order to guarantee the safety of the personnel present and of the material.

#### Handling with a Crane

- ▶ Pass the straps for slinging the unit through the holes provided on the wooden packing pallet.
- ▶ Lift carefully and avoid sudden movements.
- ▶ Position the unit close to the installation site.

#### Handling with a forklift truck

The unit can also be moved with a forklift truck using the holes provided on the base of the wooden pallet.

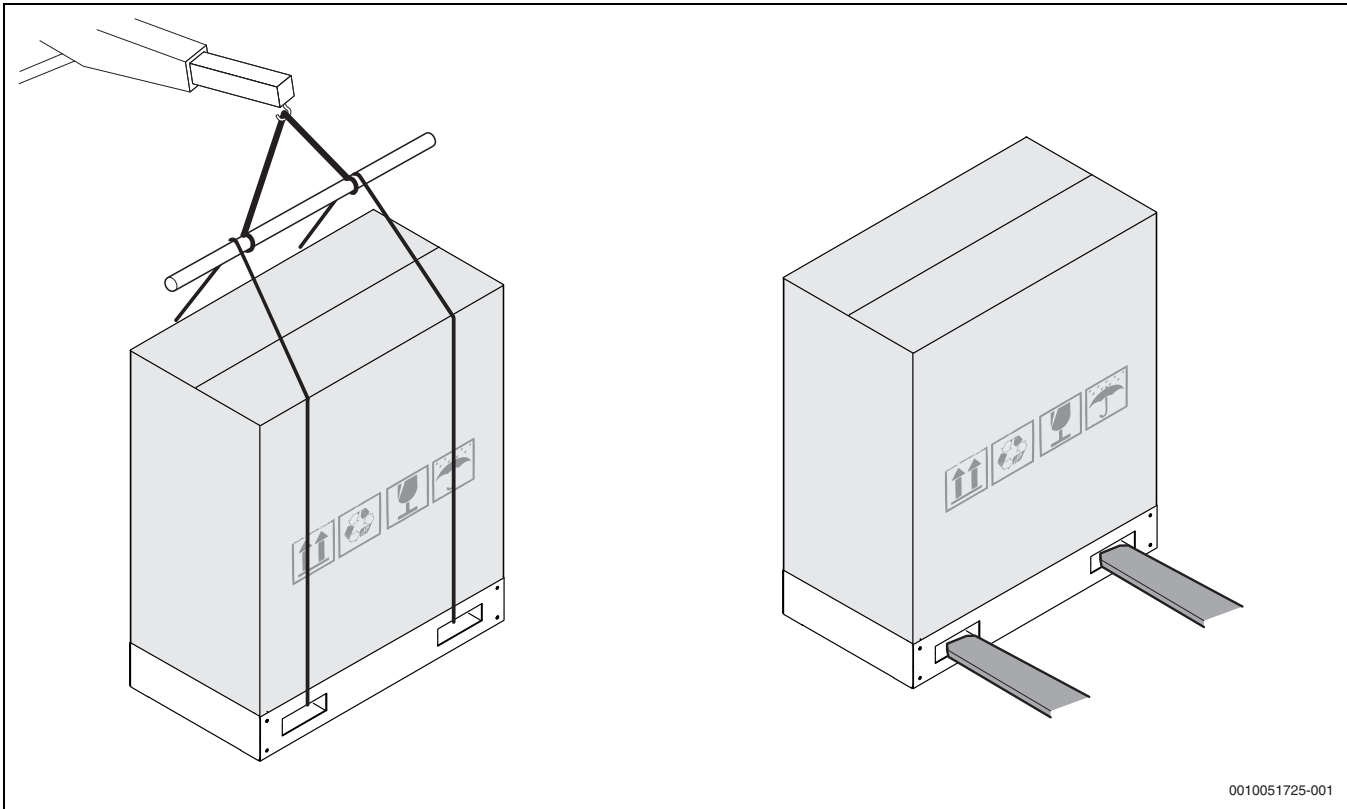

0010051725-001

Fig. 27 Handling with a forklift truck

- ▶ Identify critical points during handling (disconnected routes, flights, steps, doors).
- ▶ Protect the unit properly to prevent damage.

### 5.5 Lifting

- ▶ Verify the unit weight and the handling equipment lifting capacity.

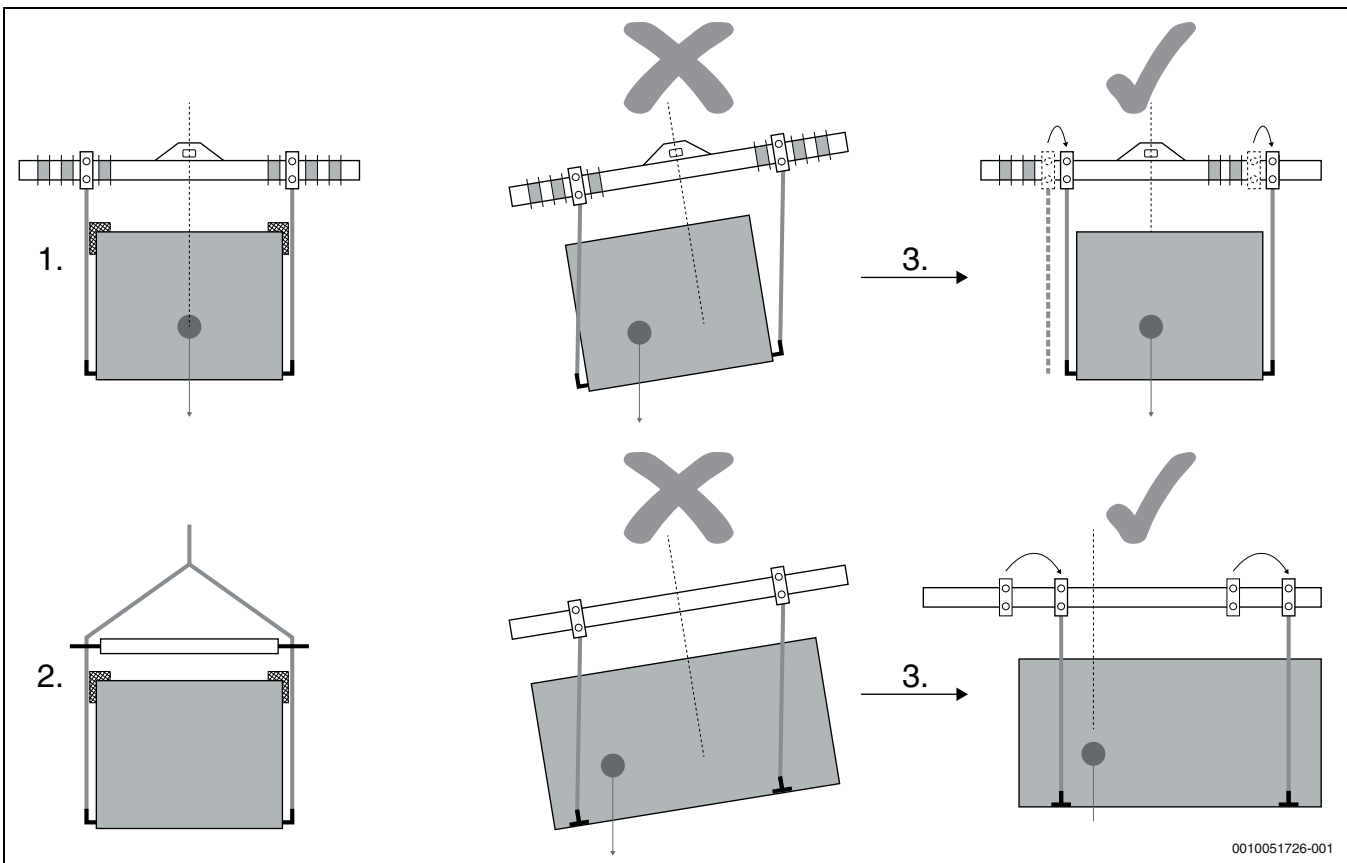

0010051726-001

Fig. 28 Lifting

- [1] Lifting with balance
- [2] Lifting with space bar
- [3] Aligning the barycenter to the lifting point

- ▶ Gradually bring the lifting belts under tension, making sure they are positioned correctly.
- ▶ Before starting the handling, make sure that the unit is stable.

**5.6 Removing packaging**

- ▶ Once you have reached the installation site, remove the wooden pallet by unscrewing the screws at the base of the unit, the packaging cardboard and the coil protection [1].

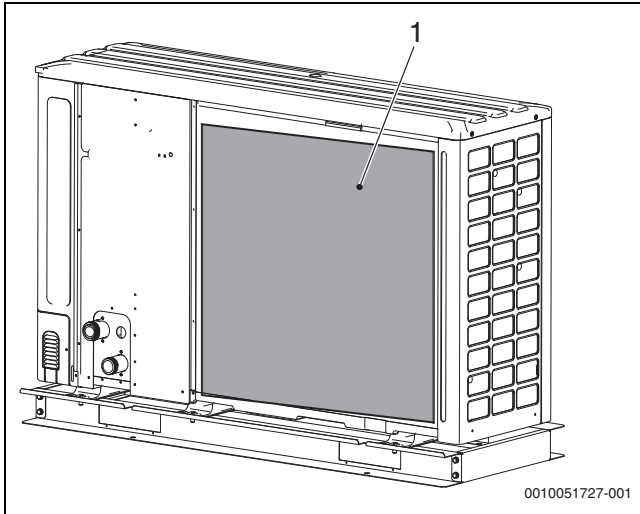

Fig. 29 Removing packaging

- [1] Coil protection

**5.7 Removing the transport bracket**

For models CS2000AWF 12 R-SC/CS2000AWF 12 R-T, CS2000AWF 14 R-S/CS2000AWF 14 R-T and CS2000AWF 16 R-S/CS2000AWF 16 R-T:

- ▶ Remove the front panel [1].
- ▶ Remove the screws [2].
- ▶ Remove the bracket [3] used during transport to avoid stressing the compressor.

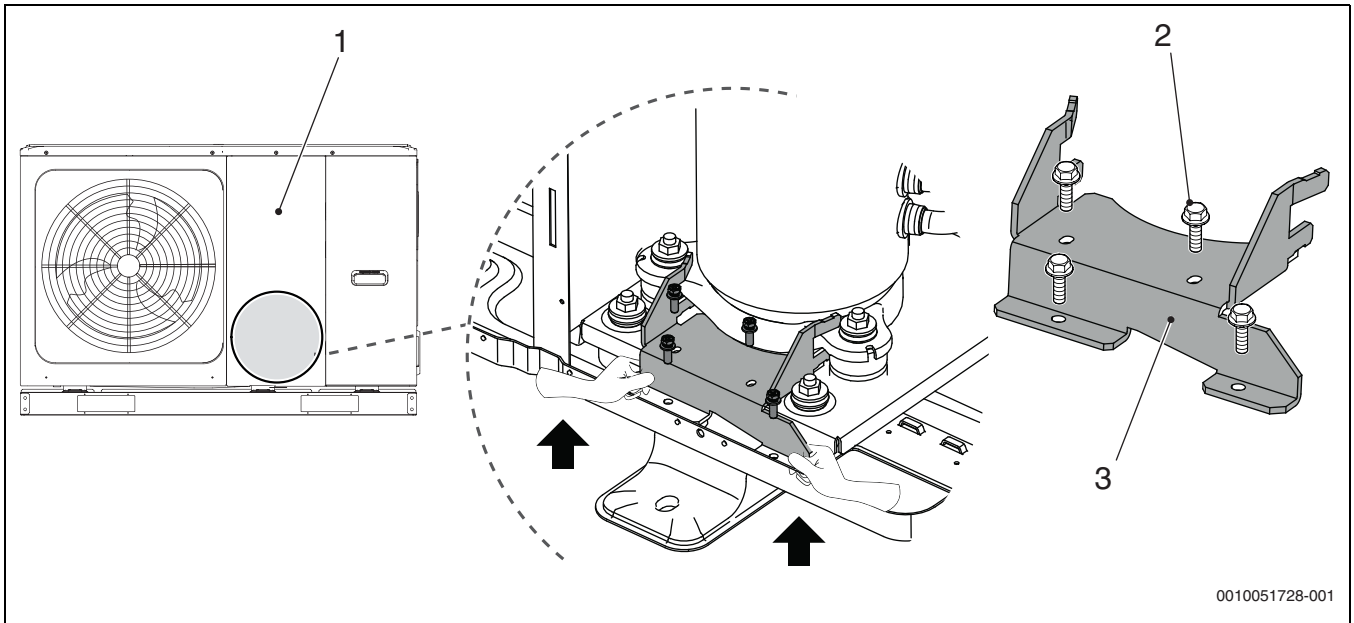

Fig. 30 Removing the transport bracket

- [1] Front panel
- [2] Screws
- [3] Bracket

**5.8 Dimensions and weights**

**5.8.1 Sizes CS2000AWF 4 R-S to CS2000AWF 6 R-S**

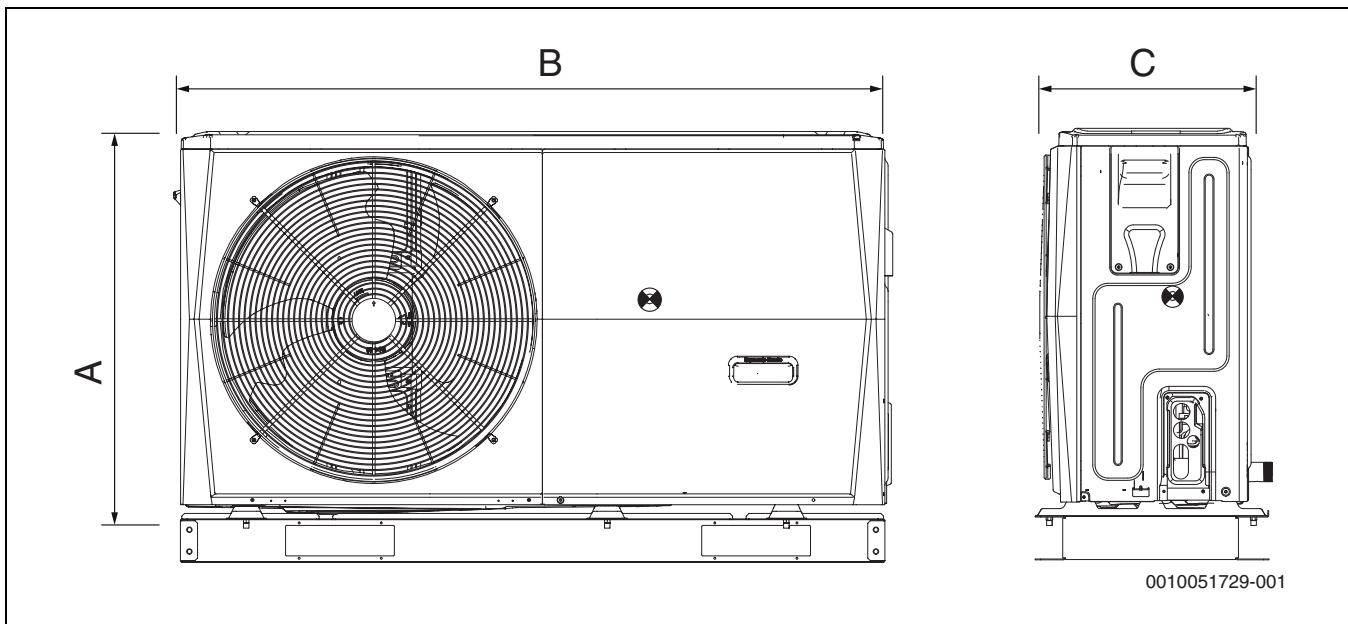

Fig. 31 Sizes CS2000AWF 4 R-S to CS2000AWF 6 R-S

		Size	
		CS2000AWF 4 R-S	CS2000AWF 6 R-S
Height [A]	mm	717	717
Width [B]	mm	1295	1295
Depth [C]	mm	400	400
Weight	kg	86	86

Table 10 Sizes CS2000AWF 4 R-S to CS2000AWF 6 R-S

**5.8.2 Sizes CS2000AWF 8 R-S to CS2000AWF 16 R-S/CS2000AWF 16 R-T**

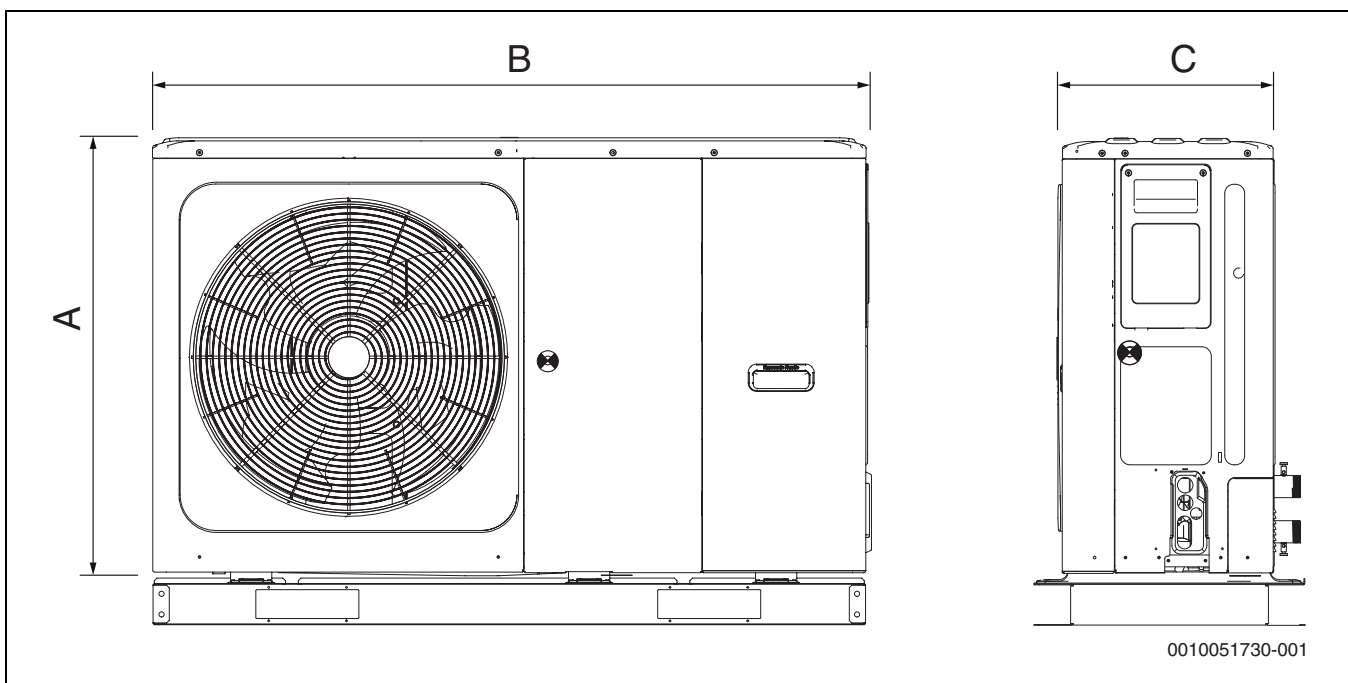

Fig. 32 Sizes CS2000AWF 8 R-S to CS2000AWF 16 R-S/CS2000AWF 16 R-T

		Size				
		CS2000AWF 8 R-S	CS2000AWF 10 R-S	CS2000AWF 12 R-S/ CS2000AWF 12 R-T	CS2000AWF 14 R-S/ CS2000AWF 14 R-T	CS2000AWF 16 R-S/ CS2000AWF 16 R-T
Height [A]	mm	864	864	864	864	864
Width [B]	mm	1385	1385	1385	1385	1385
Depth [C]	mm	445	445	445	445	445
Weight	kg	105	105	129	129	129

Table 11 Sizes CS2000AWF 8 R-S to CS2000AWF 16 R-S/CS2000AWF 16 R-T

**5.8.3 Sizes CS2000AWF 18 R-T to CS2000AWF 30 R-T**

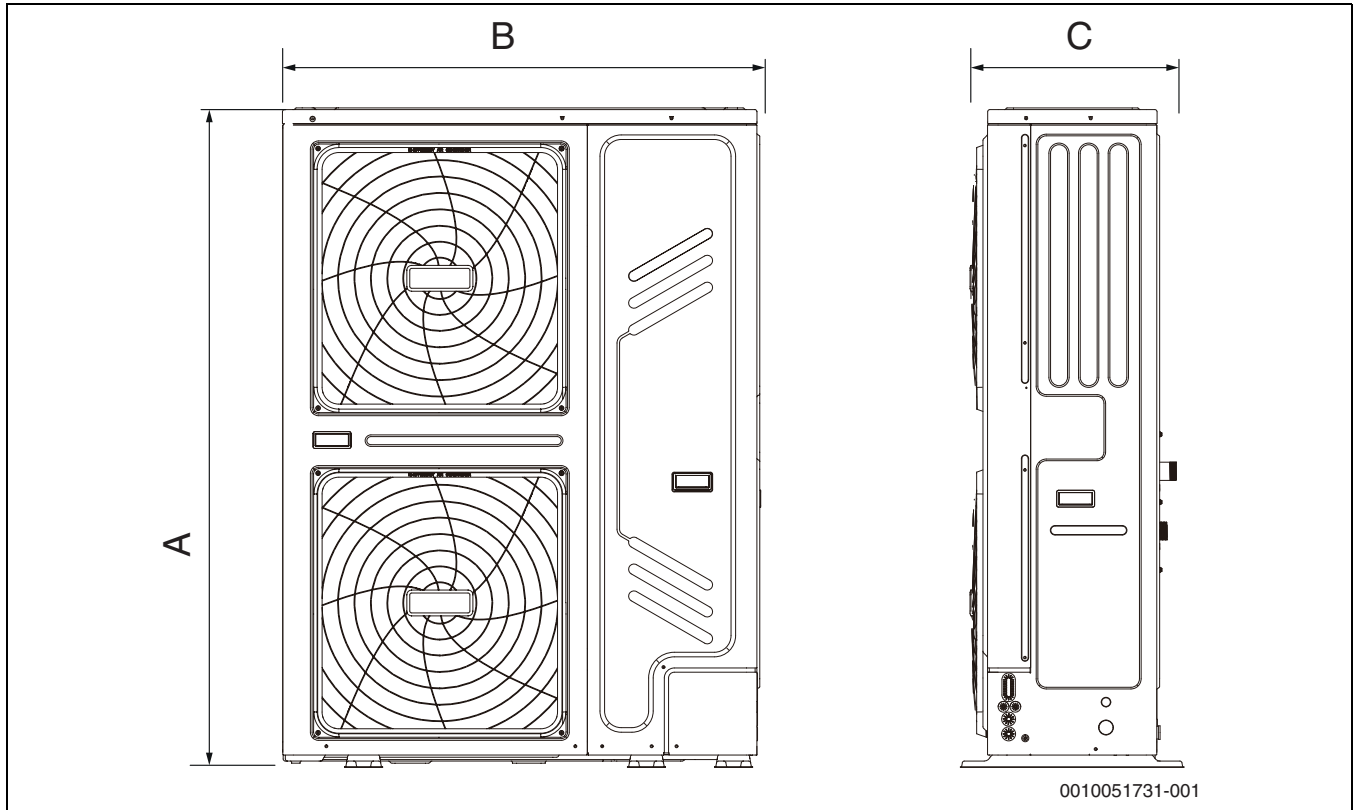

Fig. 33 Sizes CS2000AWF 18 R-T to CS2000AWF 30 R-T

		Size			
		CS2000AWF 18 R-T	CS2000AWF 22 R-T	CS2000AWF 26 R-T	CS2000AWF 30 R-T
Height [A]	mm	1557	1557	1557	1557
Width [B]	mm	1120	1120	1120	1120
Depth [C]	mm	400	400	400	400
Weight	kg	177	177	177	177

Table 12 Sizes CS2000AWF 18 R-T to CS2000AWF 30 R-T

## 6 Installation

### 6.1 General installation requirements

The installation site must fulfil the following conditions:

- Well-ventilated areas ensuring an exchange of treated air.
- Areas where the unit will not disturb neighbours.
- Safe areas that can withstand the weight and vibrations of the unit and where it can be installed on flat ground. The unit is designed for outdoor installation.
- Areas that are not exposed to flammable gas or product leaks.
- Areas free from potentially explosive atmospheres.
- Areas with adequate functional spaces including operating spaces and spaces required for extraordinary and routine maintenance.
- Areas that allow the maximum specified lengths for the unit's piping and electric cables to be adhered to.
- Areas where any water leaks from the unit cannot cause damage (e.g. if the drain pipe is blocked).
- Areas protected from prolonged exposure to sunlight or rain.
- Areas with adequate functional spaces including operating spaces and spaces required for extraordinary and routine maintenance.
- Areas protected from heat sources.
- Clean and protected areas so that the unit cannot be used as a refuge for small animals. Contact between these animals and electrical components can cause malfunctions or fires.

### 6.2 Standard installation

- The unit is designed for outdoor installation.

Be careful:

- ▶ Not to install the unit in areas that are frequently used as workspaces. In the event of construction work that produces large amounts of dust (e.g. grinding, etc.), the unit must be covered.
- ▶ Not to place any objects or equipment on the unit (on the top panel).
- ▶ Not to sit or stand on the unit.
- ▶ Not to install the unit in places with high salinity or in the presence of corrosive gases.
- ▶ Not to install the unit in places where it will be subjected to continuous vibration.
- ▶ To provide a water drain duct around the base to ensure the drainage of discharge water around the unit. If it is difficult to drain the water from the unit, place the unit on a raised base.
- ▶ The outdoor unit should be placed with a minimum distance to the sea of 500m. In France and Ireland a minimum distance of 1000m is recommended. It is recommended to place the appliance in a such a way that the evaporator does not face the sea wind.



In the event of refrigerant leaks, take sufficient precautions in accordance with applicable laws and regulations.

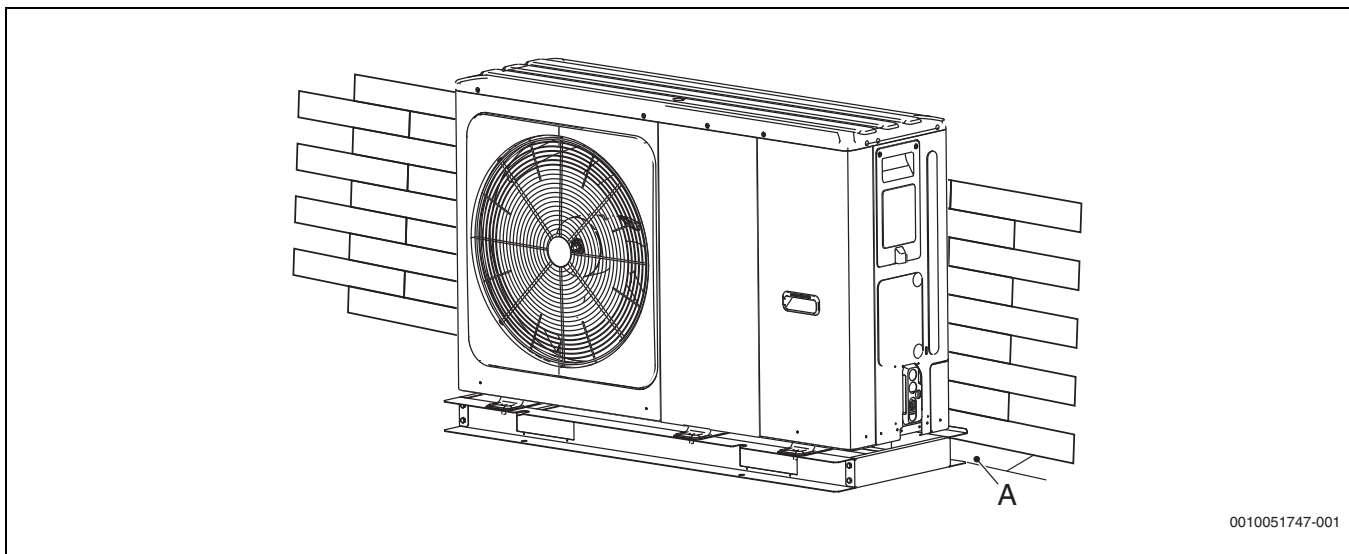

0010051747-001

Fig. 34 Standard installation for CS2000AWF 4 R-S ~ CS2000AWF 30 R-T

[A]  $\geq 300\text{mm}$

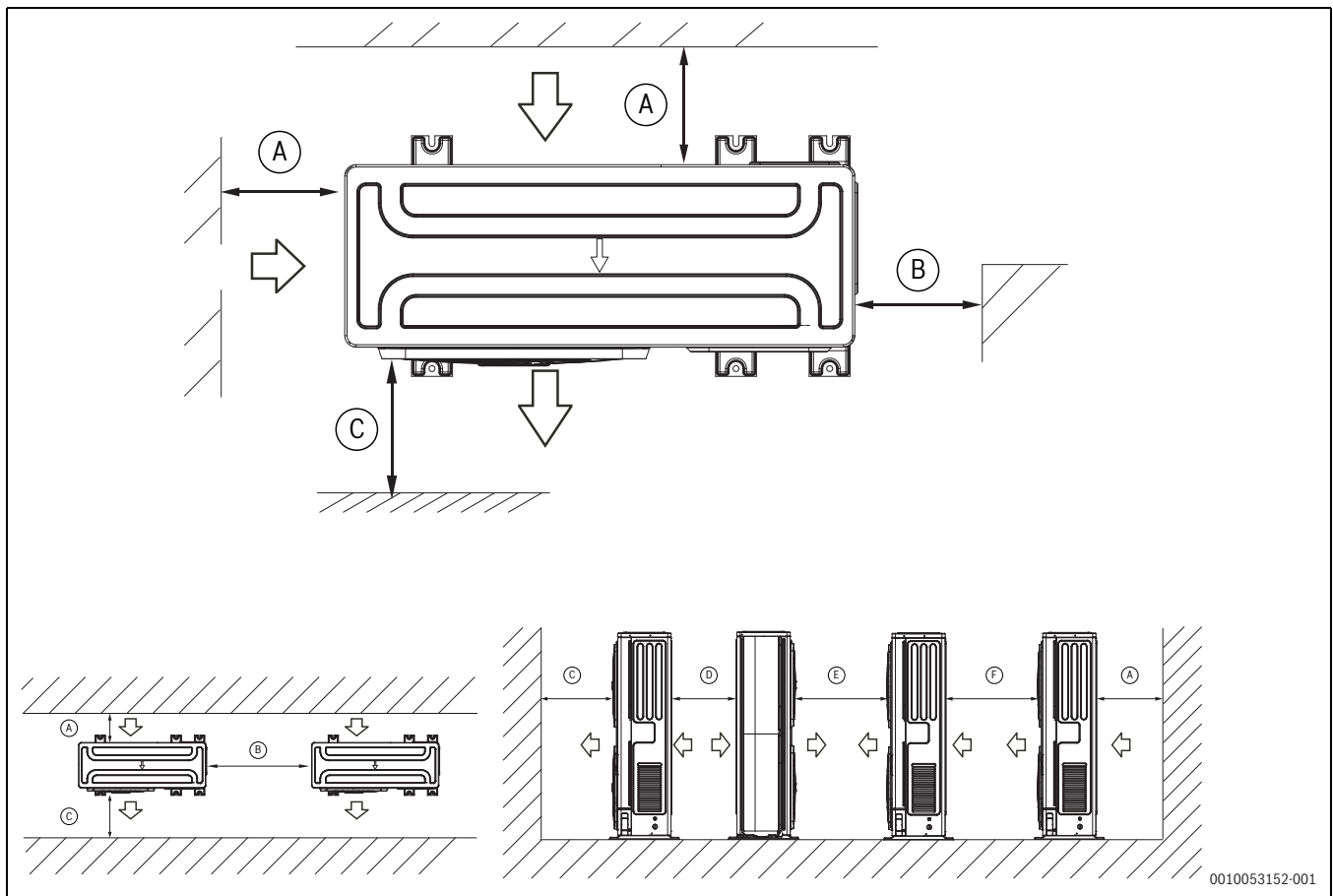

Fig. 35 Minimum clearances

Size	A	B	C	D	E	F
CS2000AWF 4 R-S ~	≥ 300	≥ 600	≥ 1000	≥ 1000	≥ 2000	≥ 2000
CS2000AWF 6 R-S						
CS2000AWF 8 R-S ~	≥ 300	≥ 600	≥ 1500	≥ 1000	≥ 3000	≥ 2500
CS2000AWF 30 R-T						

Table 13 Distance to wall, boundary element or building shield

### 6.3 Installation in extreme weather conditions

#### 6.3.1 Unit exposed to strong wind

- ▶ Do not install the unit in a location where the suction side may be directly exposed to wind.
- ▶ Install the unit so that the air outlet fan is 90° to the direction of the wind.
- ▶ If necessary, place a barrier (→ Figure 36, [A]) in front of the unit to protect it from particularly strong winds.
- ▶ Set the outlet side at right angles to the wind direction.

A wind speed of 5 m/sec. or more blowing against the unit's air outlet will cause a short circuit (exhaust air intake), the consequences of which may be as follows:

- Decrease in operational capacity.
- Frequent acceleration of ice formation.
- Interruption of operation due to high or low pressure alarm.

When a strong and continuous wind blows against the front of the unit, the fan may start to rotate very fast until it breaks.

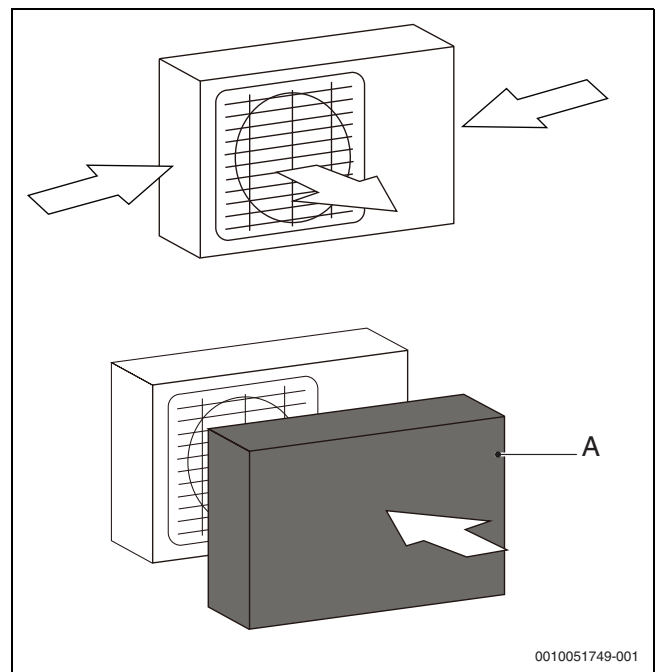

Fig. 36 Protect unit from particularly strong winds

[A] Barrier

- ▶ If the wind direction can be predicted, refer to the figures below for installation of the unit.

- ▶ Turn the air outlet side towards the wall, boundary element or building shield.

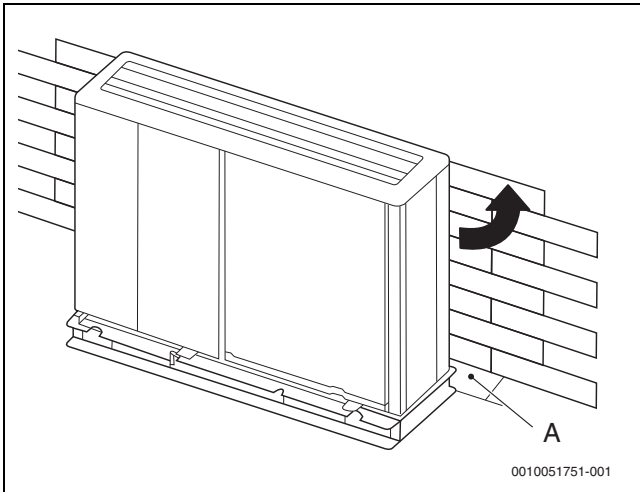

Fig. 37 Wind protection

[A] Barrier

**6.3.2 Unit exposed to direct sunlight**

Since the outdoor temperature is measured by the unit's thermistor, it is recommended to install the unit in a shady location or under a canopy to protect it from direct sunlight and heat.

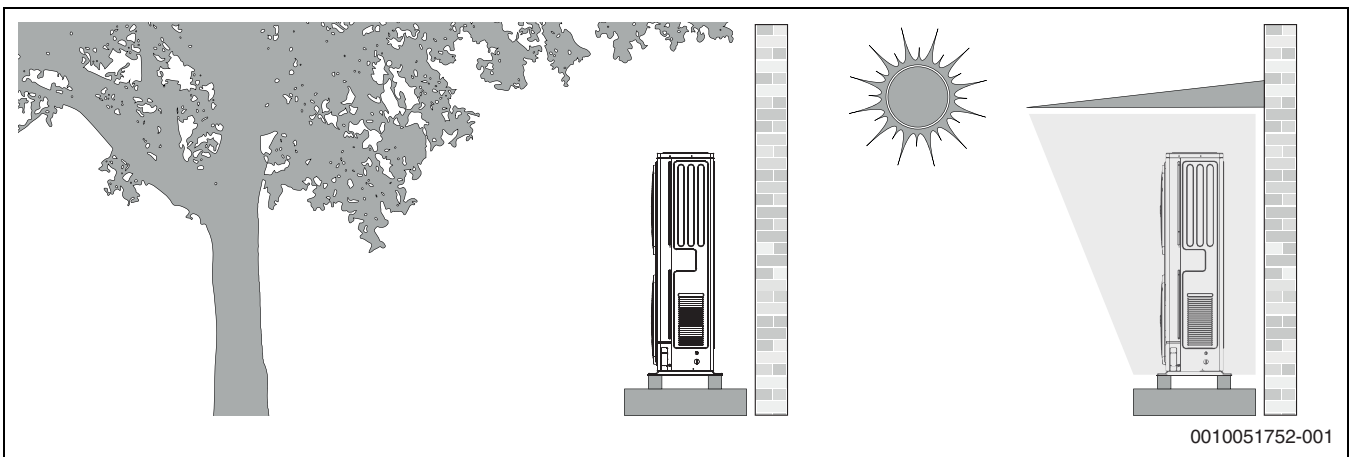

Fig. 38 Unit exposed to direct sunlight

**6.3.3 Unit exposed to heavy rain or snow**

- ▶ Install a canopy above the unit to protect it from rain or snow. Make sure the heat exchanger is not exposed to snow (if necessary, build a side canopy).
- ▶ Make sure the airflow around the unit is not obstructed.
- ▶ Provide a raised base on which to install the unit.



The base must be high enough to prevent the unit from being covered with snow. It is advisable to leave at least 100mm above the maximum height in the event of heavy snowfall.

Size	A [mm]
CS2000AWF 4 R-S ~ CS2000AWF 6 R-S	≥ 1000
CS2000AWF 8 R-S ~ CS2000AWF 16 R-S/ CS2000AWF 16 R-T	≥ 1500
CS2000AWF 18 R-T ~ CS2000AWF 30 R-T	≥ 1500

Table 14 Distance to wall, boundary element or building shield

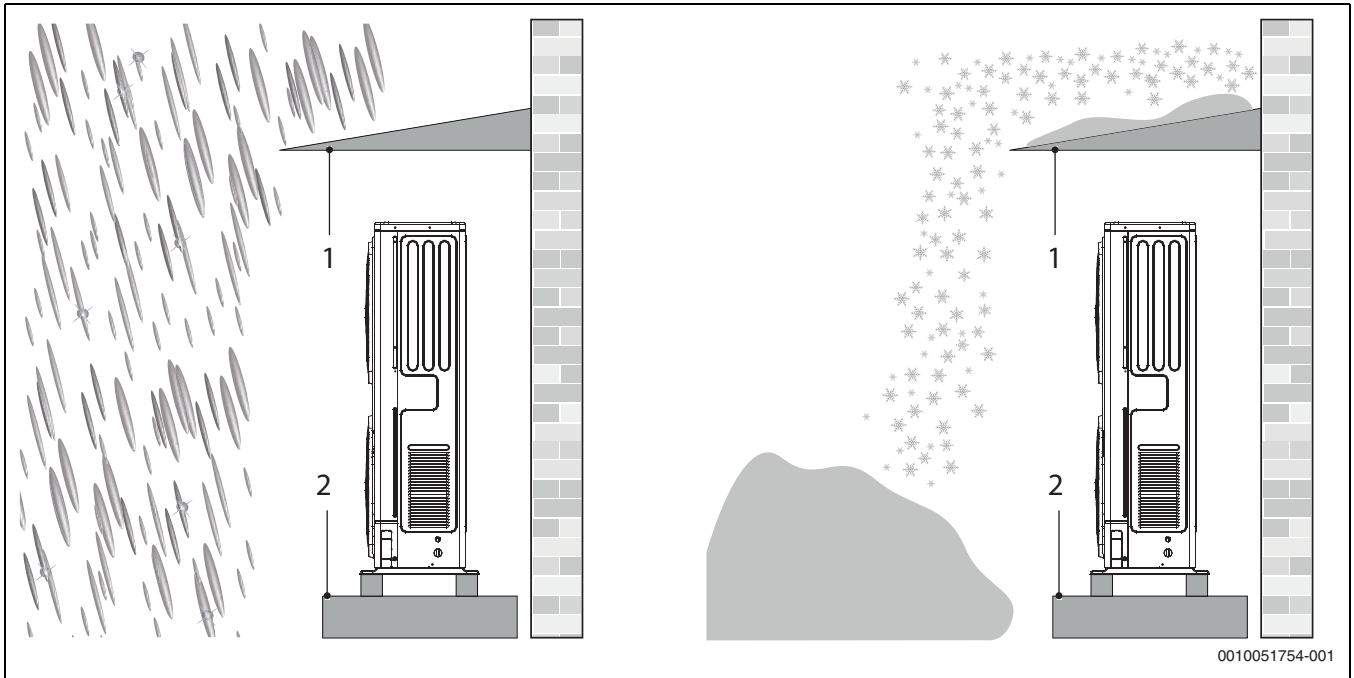

Fig. 39 Unit exposed to heavy rain or snow

- [1] Build a canopy
- [2] Build a raised base

**6.4 Ground assembly**

- ▶ Use 6 sets of M12 anchor bolts, nuts and washers to secure the unit to the base.
- ▶ Leave a space of at least 150 mm under the unit.

- ▶ Place the unit on suitable antivibration mounts sized according to the weight of the unit so as to effectively dampen vibrations.
- ▶ Use antivibration mounts provided by the supplier or equivalent.
- ▶ Rubber antivibration mounts, anti-seismic and for installation with inertial storage, with condensate drain tray or with brackets for wall installation, are available.

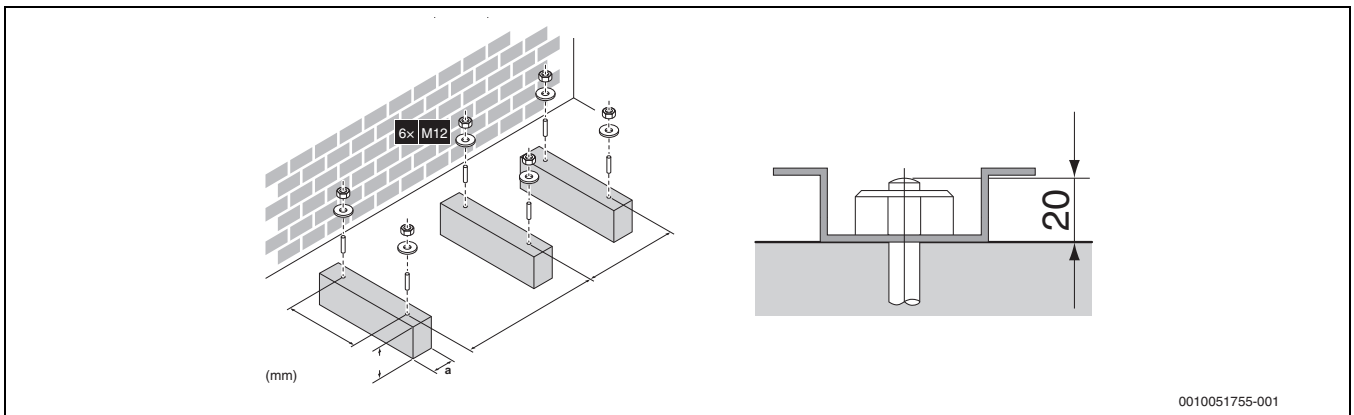
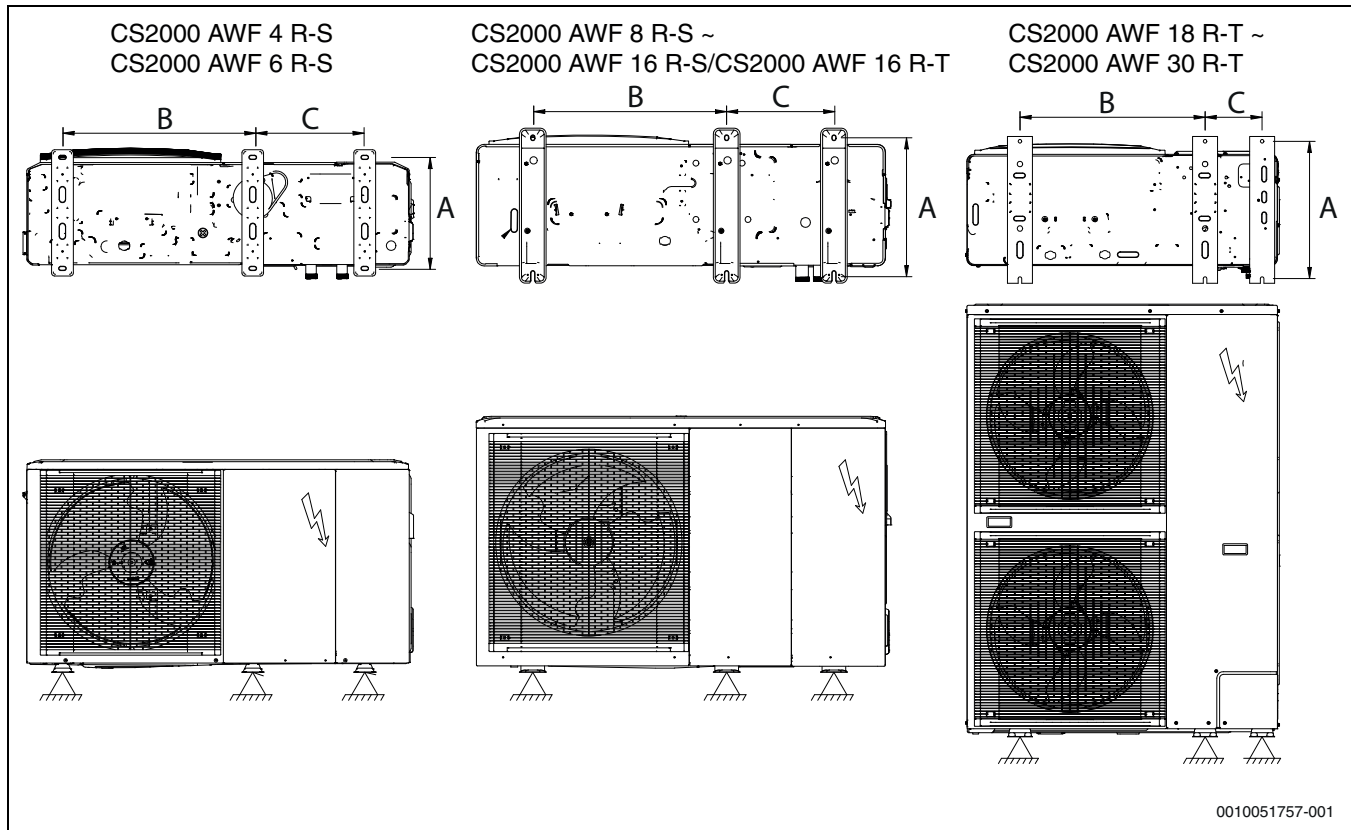

Fig. 40 Ground assembly

**6.4.1 Dimensions for ground fixing**



0010051757-001

Fig. 41 Dimensions for ground fixing

Sizes	A [mm]	B [mm]	C [mm]
CS2000AWF 4 R-S	375	644	379
CS2000AWF 6 R-S			
CS2000AWF 8 R-S	469	656	363
CS2000AWF 10 R-S			
CS2000AWF 12 R-S/CS2000AWF 12 R-T			
CS2000AWF 14 R-S/CS2000AWF 14 R-T			
CS2000AWF 16 R-S/CS2000AWF 16 R-T	494	688	206
CS2000AWF 18 R-T			
CS2000AWF 22 R-T			
CS2000AWF 26 R-T			
CS2000AWF 30 R-T			

Table 15 Dimensions for ground fixing

The recommended height of the top protruding part of the bolts is 20 mm.

 It is important to secure the unit with foundation screws, as shown in the following drawing.

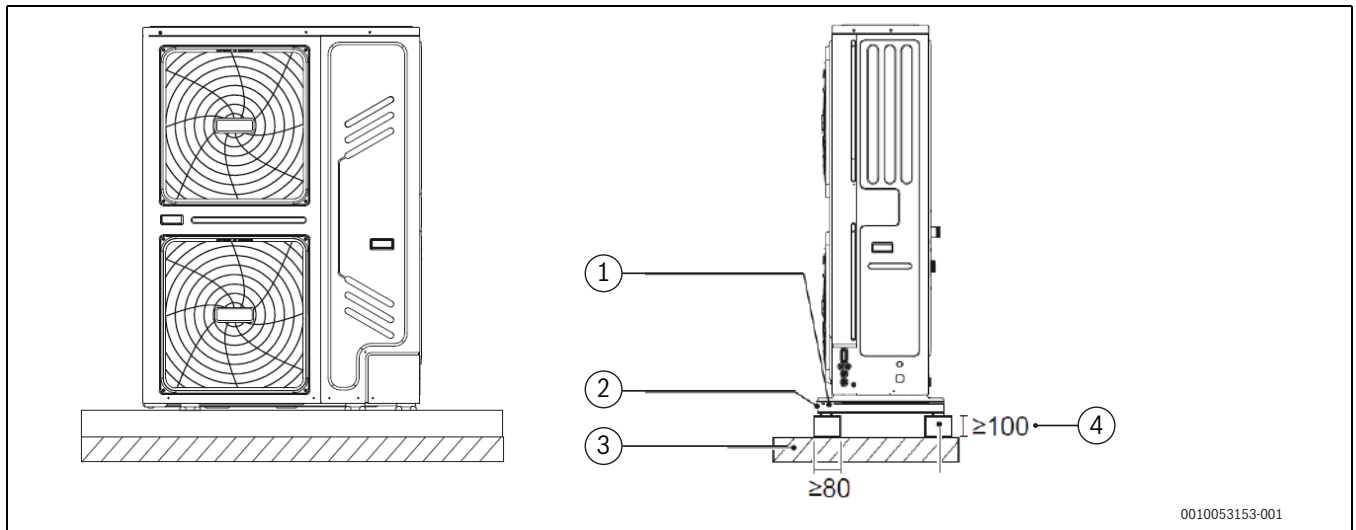

Fig. 42 Secure the unit with foundation bolts

- [1] Ø10mm expansion plug
- [2] Anti-vibration mounts
- [3] Floor or roof
- [4] Support base in concrete  $h \geq 100\text{mm}$

### 6.5 Wall assembly

Two kits are available to secure the unit to the wall:  
 bracket kit; fixings in detail A are included, wall fixings are provided by  
 the customer antivibration mount kit.

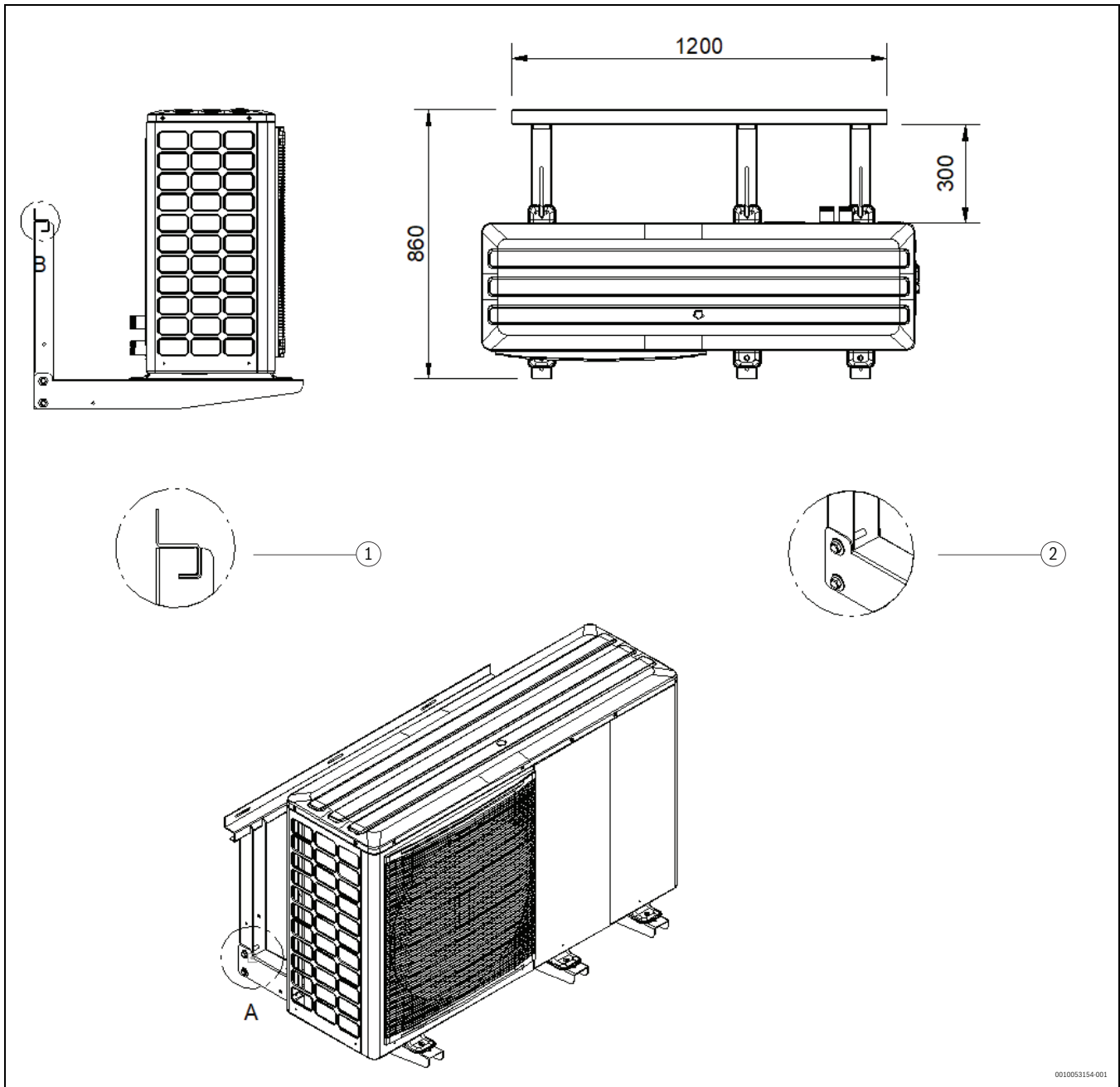

Fig. 43 Wall assembly

- [1] Interlocking assembly (B)
- [2] Brackets fixings supplied (A)

**6.6 Handling**



Do not tilt or damage the unit during handling.

- ▶ Place the unit on the installation structure using slings.

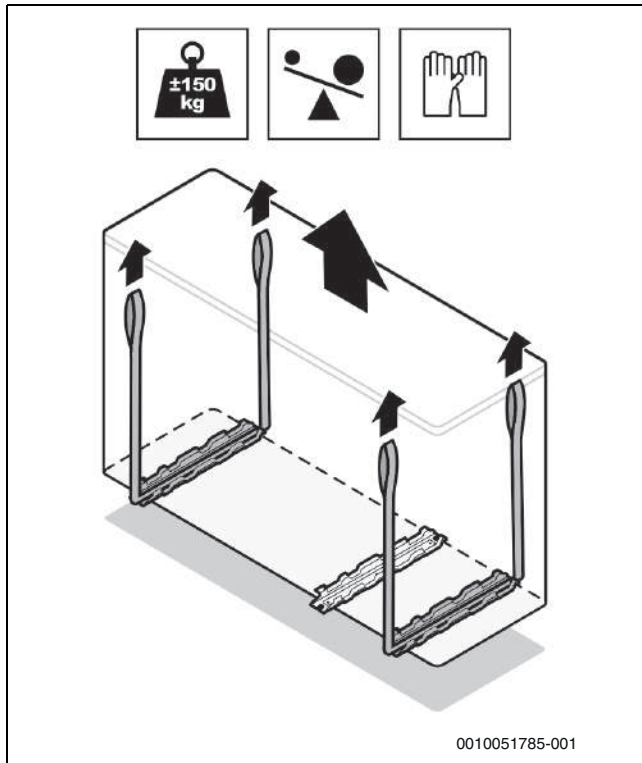

Fig. 44 Placing the unit

- ▶ Assemble the unit on the installation structure.

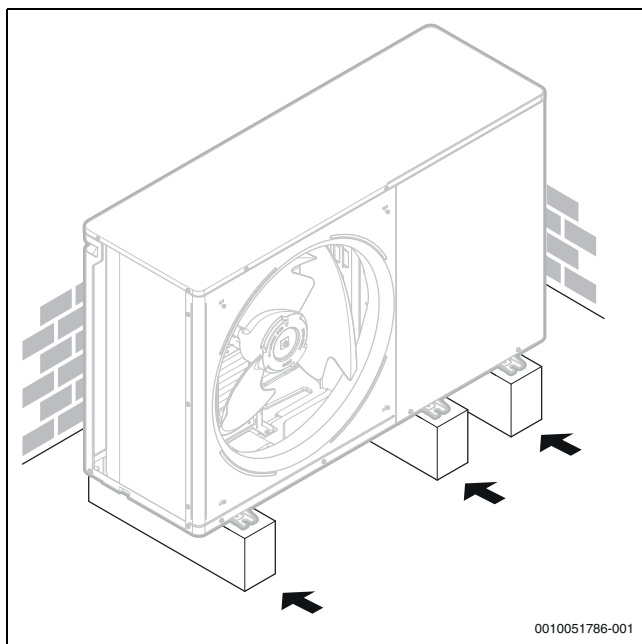

Fig. 45 Assembling the unit



If the unit's drainage holes are covered by the installation base or floor surface:

- ▶ Raise the unit to leave a gap of at least 120 mm under the unit.

- ▶ Connect the condensate drain and duct it in accordance with current regulations.
- ▶ Avoid siphons and short radius bends that can cause obstructions.



Be careful to avoid possible accidental obstructions during operation.

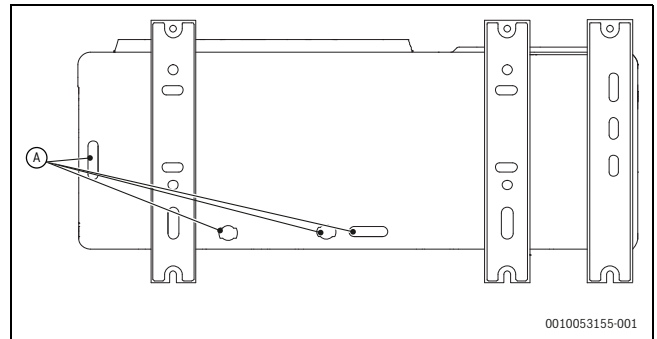

Fig. 46 Drain holes

The drain hole [A] is covered by a rubber plug. If the smaller drain hole cannot fulfil the drainage requirements, the larger drain hole can be used at the same time.

**6.7 Access to internal parts of the unit**

The appliance has removable protection panels.



**WARNING**

**Risk of electric shock, burns and scalding!**

To remove the protections:

- ▶ Unscrew the 4 screws in the panel.
- ▶ Pull the panel off.

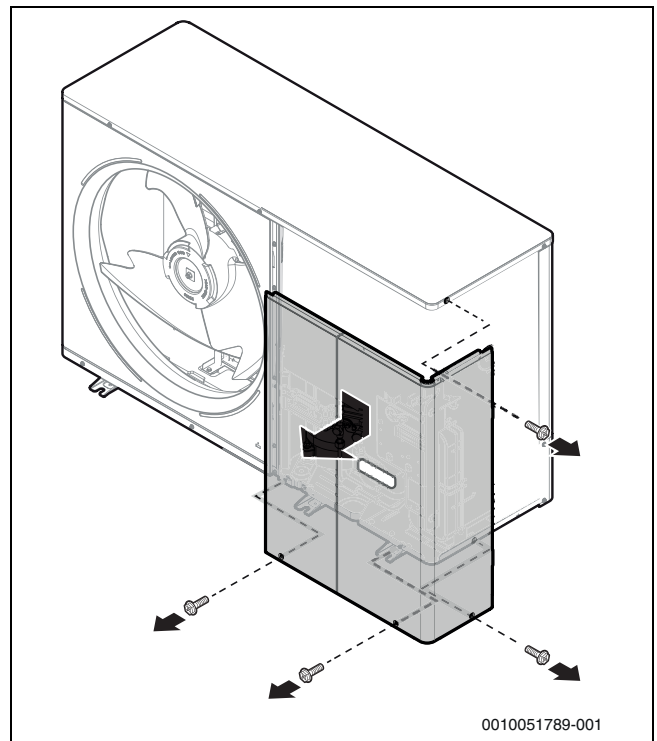

Fig. 47 Remove the protections

- ▶ Reassemble following the removal procedure in reverse order.

### 6.7.1 DHW tank

As an option, the unit can be connected to a DHW storage tank of suitable volume, by fitting the system with a 3-way diverter valve controlled by the unit.

To optimise the efficiency of the system:

- ▶ Install the 3-way valve and the DHW storage tank as close as possible to the unit.
- ▶ Use fast-switching valves with low pressure drop and reduced leakage.
- ▶ Refer to the DHW storage tank manual for installation details.

- ▶ Measure the connection pipes properly and thermally insulate them, especially if the unit is far away from the DHW storage tank.
- ▶ Nevertheless, it is advisable to connect the storage tank at no more than 10 m from the unit.



The length of the pipe between the unit and the tank must be less than 10 metres.

Outdoor unit size		CS2000AWF 4 R-S	CS2000AWF 6 R-S	CS2000AWF 8 R-S	CS2000AWF 10 R-S	CS2000AWF 12 R-S	CS2000AWF 12 R-T	CS2000AWF 16 R-T	CS2000AWF 18 R-T	CS2000AWF 30 R-T
DHW Tank Volume / L	Recommended	100 ~ 300	150 ~ 300	180 ~ 500	180 ~ 1000	500 ~ 1000				
Heat exchanger size / m <sup>2</sup> (stainless steel coil)	Minimum	1.5	1.5	1.7	1.7	2.6				
Heat exchanger size / m <sup>2</sup> (enamelled coil)	Minimum	2.0	2.0	2.5	2.5	3.5				

Table 16 DHW tank

### 6.7.2 Tank provided by a third party

When using a third-party tank, it must fulfil the following requirements:

- The tank thermistor must be placed above the heat exchanger coil.
- If possible, the additional heater should be located under the T5. In cases where this is not possible, always install a domestic hot water recirculation pump.
- Choose built-in heaters with double safety protection with manual and automatic reset thermostat in accordance with the requirements of EN 60335.



Third-party tank performance data cannot be provided and performance cannot be guaranteed.

- ▶ Use tanks and accessories for optimal performance.



The unit is standard supplied with a 10m long temperature probe. A probe of up to 30 m long can be ordered as an accessory (not recommended).

### 6.8 Condensate drain

When a heat pump is running it produces a considerable amount of water due to the defrosting cycles of the external coil.



Condensate must be disposed of so as to avoid spillage over pedestrian areas.

With particularly cold and prolonged outdoor temperatures, the condensate could freeze outside the unit, blocking the flow and generating a gradually increasing built-up of ice.

- ▶ Pay particular attention to the disposal of the condensate.
- ▶ Raise the unit off the ground.
- ▶ Consider the possibility of installing heating cables with an antifreeze function.

To prevent the water downstream of the drain from freezing:

- ▶ Install the pipe below the frost line (→ Figure 48, [5]).

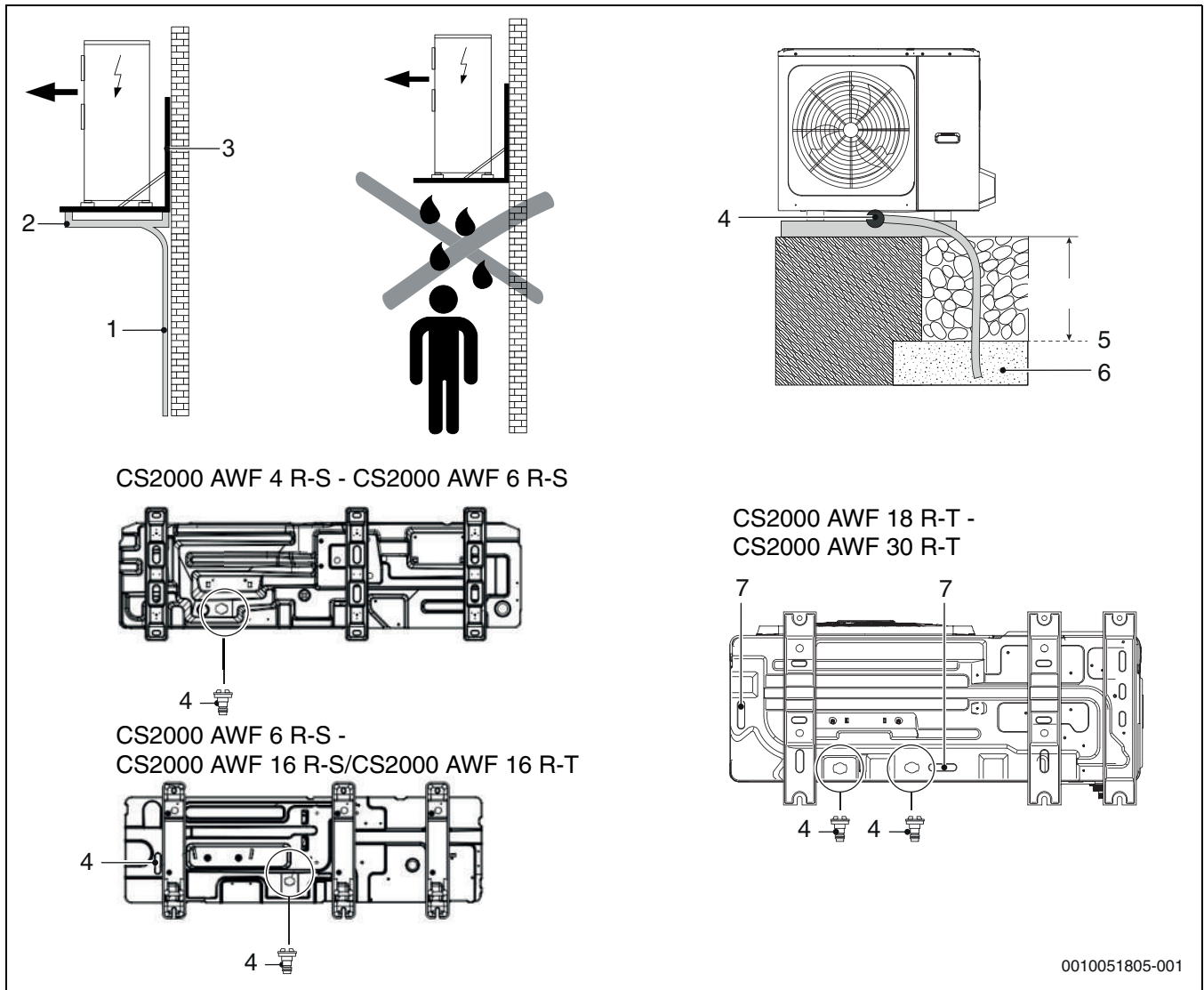

Fig. 48 Condensate drain

- [1] Condensate drain pipe (to be provided by the customer)
  - [2] DTX = Drain pan (accessory supplied separately)
  - [3] Unit mounting brackets (accessory supplied separately)
  - [4] Condensate drain connection  $\varnothing$  30
  - [5] Frost line
  - [6] Layer of gravel or pebbles to help with condensate drainage
  - [7] The drain hole is covered by a rubber plug
- If the small drain hole is not sufficient, use it with the large drain hole.

**Requirements for circulation pumps**

- The minimum water pressure must be  $\geq$  1bar;
- The maximum water pressure must be  $\leq$  3 bar;

**CAUTION**

**Circulation pumps must not be installed in series!**

Cavitation of circulation pump might occur, which can result in damaging the circulation pump.

**i**

Calculations must be performed if the system solution designed for the installation site exceeds the recommended circulation characteristics, stated in the installation manual.

**Operation of circulation pumps**

The circulation pumps are equipped with different types of control, which can be set in the field and used in different types of systems.

1. **Circulation pump at constant speed**  
The pump works according to one of three classic pre-set operating curves at constant speed.
2. **Circulation pump with proportional head**  
An operating curve is set in which the circulation pump reduces the head as the heating load in the system decreases, or the circulation pump increases the head as the load increases, in order to save energy and ensure quieter operation. It is possible to choose

0010051805-001

between three preset curves and it is advisable to use this mode in the case of distribution to terminal units or radiators.

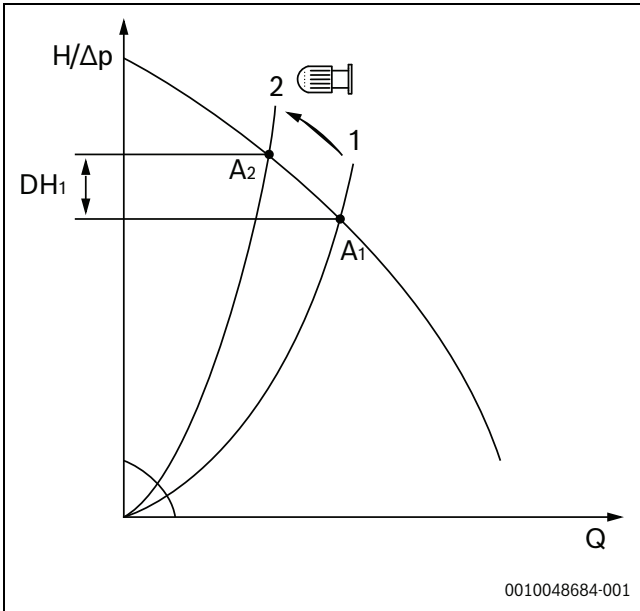

Fig. 49 Control with standard pump. Head increases by  $DH_1$ .

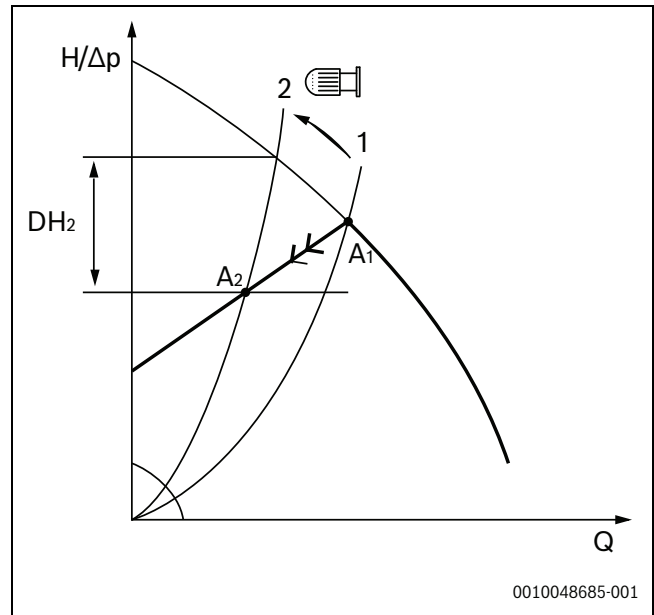

Fig. 50 Control with proportional head pump. The head is reduced by  $DH_2$ .

**3. Circulation pump with constant head**

A constant head curve is set, which the pump will maintain regardless of heating load variations in the system. It is possible to choose between three pre-set curves, and it is advisable to use this mode in the case of distribution to a radiant floor..

**7 Water connections**

The unit has supply and return connections for connection to a water distribution system. Connection to the system must be carried out by authorised technicians and must comply with current laws and regulations.

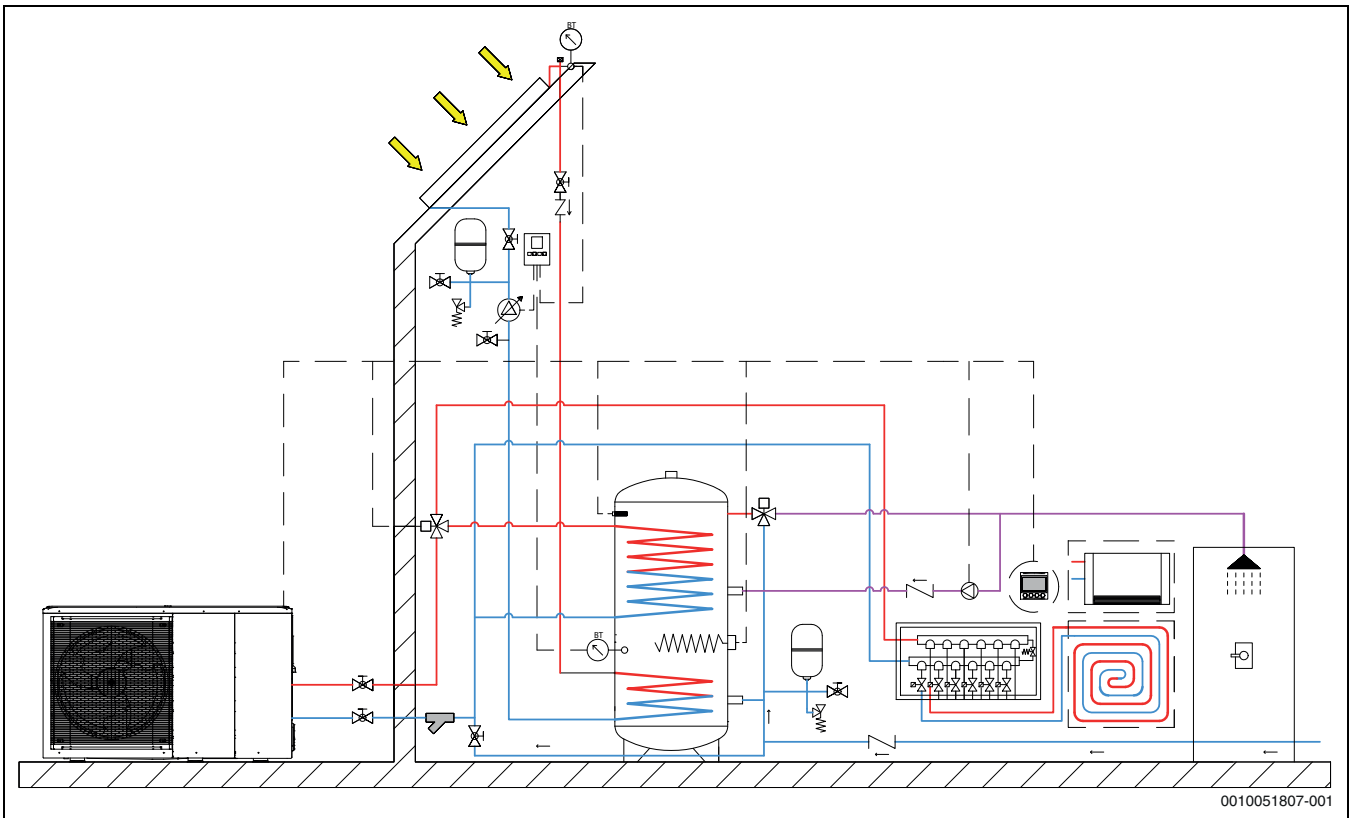

Fig. 51 Water connections

## 7.1 Preliminary check

### 7.1.1 Water circuit

Before installing the unit, do a preliminary check and ensure the following:

- The water circuit inside the unit uses copper piping: Do not use galvanised components in the system, as they may be subject to excessive corrosion.
- The maximum water pressure must be  $\leq 3$  bar.
- The maximum water temperature must be  $\leq 75$  °C.
- Use system components that are compatible with the system water and the materials making up the unit.
- The pipes and system components to be installed must be suitable to withstand the pressure and temperature of the system water.
- Shut-off valves must be installed at the lowest points of the system so that the circuit can be completely drained during maintenance.
- Air vents must be installed at the highest points of the system, in places easily accessible to the Service technician. Inside the unit there is an automatic air vent for the water circuit: Check that this is not over-tightened when charging the system, so that it can work effectively.
- The unit should only be connected to closed water circuits. Connection to an open circuit can lead to corrosion of the water pipes.

### 7.1.2 Water characteristics

Circulators are designed to operate optimally only with clean, good quality mains water and may be affected by the presence of oxygen, limescale, sludge, abnormal acidity levels and other substances (including chlorides and minerals). The same can be said for the plate heat exchanger.

Excessive water hardness can create deposits and limescale build-up that can damage the unit. The presence of critical concentrations of other components in the circuit can trigger corrosive processes or other quality problems in the circulator and plate heat exchanger.

- ▶ Check that the system water complies with the concentration limits given in the table.



If the water hardness is too high:

- ▶ Assemble a water softener to reduce the value.

### 7.1.3 Water quality in the heating system

Heat pumps operate at lower temperatures than other heating systems which means that the thermal de-airing is not as effective and oxygen levels are never as low as with a system incorporating an electric/oil/gas boiler. This means that the heating system will be more susceptible to corrosion when exposed to aggressive water.

Preventive actions are required if the heating system require recurrent filling or where a heating water sample don't show clear water.

Preventive actions can be to supplement the heating system with a magnetite filter and a de-airing valve.

When the heating system requires recurrent filling:

- ▶ Check that the volume of the expansion vessel is sufficient to the heating system volume.
- ▶ Replace the expansion vessel.
- ▶ Check the heating system for leaks.

A system separation with the help of a heat exchanger may be required if the limits in table 17 can not be achieved.



**Do not use any water additives except for a non-toxic pH-enhancer and keep the water clean.**



### CAUTION

#### Corrosion!

- ▶ Heating system must be airtight.
- ▶ Materials must be chosen that are not sensitive to oxygen diffusion.

Characteristics	Water component for corrosion limit on Copper
pH (25 °C)	7.5 to 9.0
SO <sub>4</sub> <sup>2-</sup>	< 100
HCO <sub>3</sub> <sup>-</sup> / SO <sub>4</sub> <sup>2-</sup>	> 1
Total Hardness	8 to 15 °F (4.5-8.5 dH)
Cl <sup>-</sup>	< 50 ppm
PO <sub>4</sub> <sup>3-</sup>	< 2.0 ppm
NH <sub>3</sub>	< 0.5 ppm
Free Chlorine	< 0.5 ppm
Fe <sub>3</sub> <sup>+</sup>	< 0.5 ppm
Mn <sup>++</sup>	< 0.05 ppm
CO <sub>2</sub>	< 50 ppm
H <sub>2</sub> S	< 50 ppm
Temperature	< 65 °C
Oxygen content	< 0.1 ppm
Sand	10 mg/L 0.1 to 0.7mm max diameter
Ferrite hydroxide Fe <sub>3</sub> O <sub>4</sub> (black)	Dose < 7.5 mg/L 50% of mass with diameter < 10 µm
Iron oxide Fe <sub>2</sub> O <sub>3</sub> (red)	Dose < 7.5mg/L - Diameter < 1 µm

Table 17 Corrosion limits

A poor quality of the heating water promotes the formation of sludge and lime-scale. This can lead to malfunctions and damage of the heat exchanger in the heat pump. According to the current guideline VDI 2035 "Prevention of damage in water heating installations" and depending on the degree of hardness of the filling water, the system volume and the total output of the system, water treatment may be required to avoid damage due to the formation of lime-scale.



If the limits for water hardness stated in table 17 are exceeded, the performance of the heat pump will deteriorate over time. If this performance degradation can be accepted, the limits in figure 52 are required to ensure the operation of the heat pump throughout its entire service life.

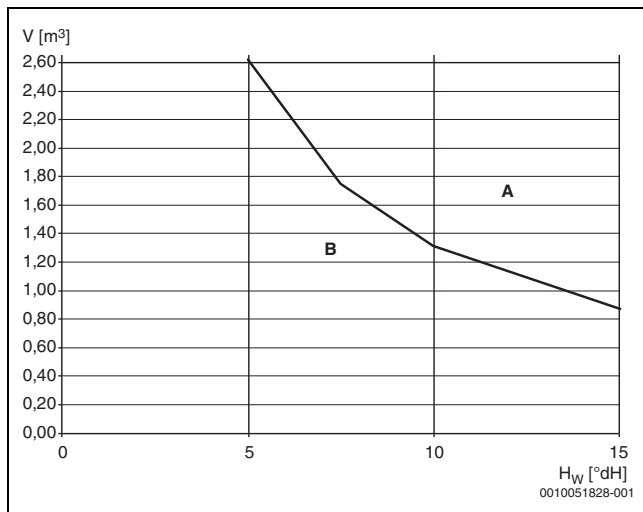

Fig. 52 Required limits for heat pump output < 50 kW

- A Use completely de-mineralized fill water above the curve, conductivity ≤ 10 microsiemens /cm.
- B Use untreated tap water below the curve. Fill according to the drinking water regulation.
- H<sub>W</sub> Water hardness
- V Total water volume: fill volume of the heating system and top-up volume over the service life of the heat pump.

If the total water volume is above the limit curve in the diagram suitable measures are required for water treatment. Suitable measures are: Use of fully de-mineralized fill water with a conductivity of ≤ 10 microsiemens / cm.

To prevent oxygen from entering the heating water, the expansion vessel must be adequately dimensioned. When installing diffusion open pipes, a system separation with the help of a heat exchanger is required.

**7.1.4 Water quality for potable water (DHW)**

The integrated domestic hot water cylinder is constructed to heat and store potable water.

- ▶ Follow country-specific regulations, directives and standards for drinking water.
- ▶ The water quality in the cylinder has to comply with the framework of the EU directive 2020/2184.

The following values must be emphasized:

Water quality	Unit	Value
Conductivity	µS/cm	≤ 2500
pH		6,5 to ≤ 9,5
Chloride	ppm	≤ 250
Sulpahte	ppm	≤ 250

Table 18 Water quality for potable water (DHW)

**7.2 General system requirements (to be provided by the customer)**

**7.2.1 Air vent valves**

- ▶ Provide air vent valves at all high points of the system to allow air to escape from it.

**7.2.2 Water filter on Domestic Hot Water side**

To avoid clogging the system and the exchanger:

- ▶ Install a filter to capture any water impurities at the mains water inlet and in a position easily accessible for cleaning.



The filter is to be provided by the customer, installed on site, never removed and periodically checked for clogging.

**7.2.3 System side water filter**

In order to maintain optimal operation of the unit:

- ▶ Install a filter on the return line of the system.



The mesh filter standard supplied with the unit should never be removed and periodically checked for clogging.

In addition to the filter supplied, we recommend installing a dirt separator filter to trap not only general dirt, but also fine ferromagnetic particles and parts dispersed during use that are not trapped by the mesh filter.

If both filters are present:

- ▶ Place the mesh filter upstream on the return line.

Compatibly with the need to limit pressure drops, having a double filter of different types in series will protect the unit better from dirt and impurities in the carrier fluid.

**7.3 Water pipes**

The water circuit connections must be done correctly and in accordance with the unit's specifications, respecting the water entering and leaving.

The system must always meet the minimum requirements for water quantity and quality and be protected from sludge, contaminants and encrustations.

**7.3.1 General instructions for piping**

Always take the following into consideration when connecting the water circuit:

- ▶ Use only clean pipes: air, humidity, dirt or dust can cause problems.
- ▶ Keep the end of the pipe downwards when removing burrs.
- ▶ Cover the end of the pipe when inserting it through a wall to prevent dust and dirt from entering.
- ▶ Use a good thread sealant to seal the connections. The seal must be able to withstand the pressures and temperatures of the circuit.
- ▶ When using non-copper metal piping, isolate the two types of materials from each other to prevent galvanic corrosion.
- ▶ Pay attention not to deform the pipes by using excessive force or unsuitable tools during connection: This could cause the unit to malfunction.

**NOTICE**

**Unsuitable tools can damage the pipes.**

**7.3.2 Installing a water filter**

The unit can also be seriously damaged by impurities in the water: welding residues, slag, mineral oil, sludge, dirt, etc. One option to limit pollutants in the water is to install a filter, which is always necessary.

Various types of filters can be used:

- Mesh filter (mandatory on DHW circuit and system side): Designed to trap large dirt particles and usually positioned in the part of the circuit with the highest flow-rate.
- Fabric filter: Designed to trap the finer particles.
- Magnetic dirt separator filter (mandatory on system circuit): Designed to trap sludge and ferrous residues.

Before connecting the water to the unit:

- ▶ Clean the system thoroughly with specific and effective products to remove residues or impurities that could affect operation.

**7.3.3 Magnetic dirt separator filter**

It is highly recommended to install the magnetic dirt separator filter on the system circuit.

**7.3.4 Installation in new systems**

During installation, residues (welding, slag, joint products, etc.) or preservatives (e.g. mineral oil) can build up in the circuit.

Before start-up, in new installations:

- ▶ Thoroughly flush the entire system.

When cleaning:

- ▶ Empty the water circuit completely to prevent corrosive or aggressive components remaining in the final charge.
- ▶ Check that the downstream filters are clean.
- ▶ Fill the system with clean, good quality mains water.
- ▶ If necessary, clean several times until the filters become dirty.

**7.3.5 Installation in existing systems**

If the unit is to be installed in an existing system:

- ▶ Flush the system thoroughly to remove particles, sludge and slag.



Drain the system before the new unit is installed.

- ▶ Dirt can only be removed with an adequate water flow-rate: Wash each section separately.
  - Pay particular attention to “blind spots”, where due to the low flow-rate a lot of dirt can accumulate.
- ▶ Fill the system with clean, good quality mains water.
- ▶ After rinsing, check the quality of the water in the system.
  - if it is inadequate, further measures must be taken to avoid problems.



The warranty does not cover damage caused by limescale build-up, deposits and impurities deriving from the water supply and/or failure of the system cleaning process.

**7.4 Water circuit frost protection**

**NOTICE**

**Serious damage due to ice.**

The unit is designed to be installed outdoors and can therefore be exposed to sub-zero temperatures.

- ▶ Prevent ice from forming in the water circuit.



Damage from freezing is not covered by the warranty.

If the unit is not started for a long time:

- ▶ Make sure it remains powered and on stand-by.

When the unit is on stand-by, the software uses special functions that activate the heat pump to protect the whole system from freezing. When the temperature of the water in the circuit falls below a certain value, the unit will heat the water by activating the circulation or the additional electric heater. The freeze protection function is only disabled when the

temperature rises above a threshold that does not pose any risks to the system.

In the event of a blackout or power failure, the above freeze protection functions cannot be activated.

For applications where there is a risk of freezing:

- ▶ Provide an antifreeze liquid or an automatic frost protection valve to be fitted in the water circuit.
- ▶ Opt for the solution proposed by the supplier.
- ▶ Pay attention to the accessory’s manual.

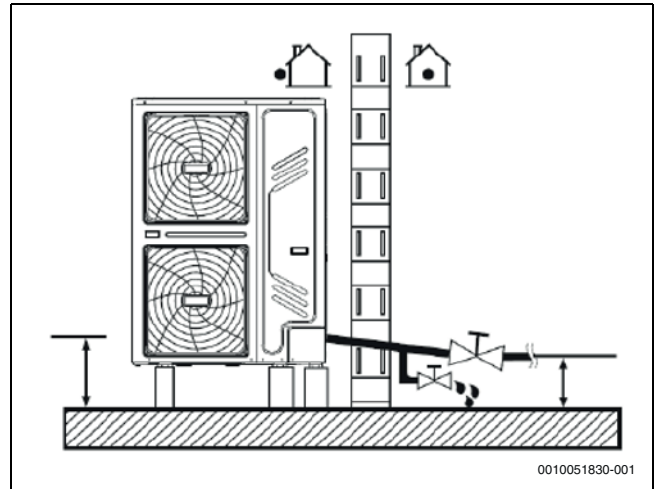

Fig. 53 Water circuit frost protection

**NOTICE**

**Damage of unit and pipes due to freezing.**

- ▶ If the power supply has to be disconnected, the water in the circuit must be completely drained.
- ▶ Do not restart the unit if there is no water in the circuit.

To protect the unit from icing up:

- ▶ Protect the pipes.
  - All the internal parts of the unit's water circuit are insulated to reduce heat loss.
  - Also provided insulation for the pipes to be installed on site.
- ▶ Provide pipes with heating cables placed underneath the insulation.

**7.4.1 Using an antifreeze liquid**

The recommended antifreeze fluid is glycol, which, depending on its concentration in the water, can lower the freezing temperature. A generic system can use ethylene glycol or propylene glycol (category III according to EN1717, with inhibitors), while systems with DHW storage tank require only propylene glycol.

The presence of glycol in the system may make it necessary to install an additional expansion tank. Take this into account in installation assessments.

- ▶ Depending on the minimum expected outdoor temperature, put a concentration of glycol into the water circuit as per the table below.

The use of glycol changes performance of the unit: the operating performance can be estimated by multiplying the correction factors by the nominal operating values.

MIN outdoor temperature	Glycol concentration	Cooling capacity	Correction factors		
			Power input	Water resistance	Water flow
0 °C	0%	1	1	1	1
-5 °C	10%	0.984	0.998	1.118	1.019

MIN outdoor temperature	Glycol concentration	Correction factors			
		Cooling capacity	Power input	Water resistance	Water flow
-15 °C	20%	0.973	0.995	1.268	1.051
-25 °C	30%	0.965	0.992	1.482	1.092

Table 19 Ethylene glycol table

MIN outdoor temperature	Glycol concentration	Correction factors			
		Cooling capacity	Power input	Water resistance	Water flow
0 °C	0%	1	1	1	1
-4 °C	10%	0.976	0.996	1.071	1
-12 °C	20%	0.961	0.992	1.189	1.016
-20 °C	30%	0.948	0.988	1.380	1.034

Table 20 Propylene glycol table



Depending on the type of glycol selected, the concentrations may differ from the values in the tables. Always compare these requirements with the glycol supplier's specifications and use the actual specification values of the product used. The glycol concentration must never be > 30%.

Glycol is a toxic fluid and should not be discharged freely: it must be collected and possibly reused. It must contain inhibitors so that it does not become acidic in contact with oxygen: in the presence of copper and at high temperatures this happens quickly.

Uninhibited acid glycol attacks metal surfaces and forms galvanic corrosion cells that cause severe damage to the system.

Carefully check that:

- the glycol is compatible with the materials used in the system;
- water treatment is carried out correctly by a qualified specialist;
- the glycol chosen has corrosion inhibitors to counteract the acids formed by oxidation;
- only propylene glycol is used in installations with Domestic Hot Water tanks;
- no automotive glycol is used (corrosion inhibitors have a limited lifespan and contain silicates that can damage or clog the system);
- galvanised pipes are not used in glycol systems, as they can cause certain components of the glycol corrosion inhibitors to break down;
- no mixtures of different types of glycol (e.g. ethylene and propylene) are used.

Glycol absorbs humidity from its environment, reducing its concentration.

If glycol is used:

- ▶ Duct the pressure relief valve in accordance with the regulations in force.



Take into account the toxicity and associated risks of glycol.

- ▶ Avoid exposing glycol to air as much as possible.
- ▶ Do not use glycol that has been exposed (e.g. glycol container left open), it may not adequately protect against freezing.

#### 7.4.2 Using automatic frost protection valves

Automatic frost protection valves are available as an accessory and drain water from the circuit, preventing freezing.

Depending on the higher activation temperature of the frost protection valves, it may be necessary to adjust the minimumCooling setpoint:

- ▶ Carefully set it at least 2 °C higher than the minimum allowed (minimum default cooling setpoint = 5 °C; recommended minimum setpoint with freeze protection valves = 7 °C) to prevent the valves from draining the system when it is operating in Cooling mode.

#### NOTICE

##### Water drainage

In the presence of water with glycol, do not use frost protection valves as they may drain it from the circuit.

- ▶ Install valves at all low points of the system (see the valve kit manual for further details on installation).
- ▶ Provide normally closed valves, installed inside but as close as possible to the unit's water connections, so as not to unnecessarily drain the entire system when the frost protection valves activate.

- ▶ Refer to the frost protection valve kit manual for further details.

#### 7.4.3 Protection of flow switch against frost

When the system is drained (manually or with an automatic frost protection valve), some water may remain in the flow switch and not be drained by activation of the valves: At sufficiently low outdoor air temperatures it can freeze.

When the flow switch is frozen:

- ▶ Turn the flow switch anticlockwise and remove it.
- ▶ Dry it carefully.
- ▶ Put it back in its original position.

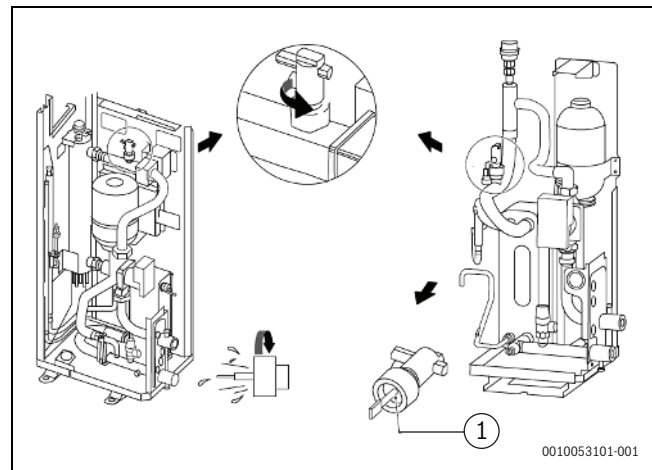

Fig. 54 Sizes CS2000AWF 4 R-S~CS2000AWF 16 R-T/  
CS2000AWF 30 R-T

- [1] Keep dry



It is advisable to carry out this operation every time the system is emptied and at the beginning of the winter season if the unit is used as a process chiller (operation in cooling mode even in winter).

**7.4.4 Protection of Domestic Hot Water storage tank**

When the storage tank is full, the house may not be inhabited immediately or the unit may be left off for long periods.

- ▶ Empty the tank to avoid water stagnation or, at sufficiently low temperatures, freezing.
- ▶ Do not supply the storage tank heaters with electricity if the storage tank is not full.
- ▶ Refer to the specific storage tank instructions for all other details when using the manufacturer's accessories.

**7.5 Pipe insulation**

All the water circuit pipes must be insulated to prevent condensate from forming during cooling mode operation, reduction of the delivery capacity and freezing of the pipes outside during winter.

The insulation material must be selected according to the requirements in the table below and be at least class B1 fire resistant and comply with current regulations.

Pipe length [m]	Minimum insulation thickness [mm]
< 20	19
20 ~ 30	32
50 ~ 40	40
40 ~ 50	50

Table 21 Pipe insulation

**i** To prevent outdoor pipes from freezing, the insulation thickness must be > 13 mm and have a thermal conductivity of  $\lambda=0.039$  W/mK. If the outdoor temperature is likely to be > 30 °C and relative humidity > 80%, a thickness of > 20 mm should be used to prevent condensate on the outer surface of the insulation.

**7.6 Water volume, system pressure and expansion tank control**

- ▶ Check that the system has the minimum water content.

The total volume of water, excluding that contained in the unit, must exceed the values in the table:

Size	MIN water volume [ l ]
CS2000AWF 4 R-S to CS2000AWF 6 R-S	30
CS2000AWF 8 R-S to CS2000AWF 16 R-S/ CS2000AWF 16 R-T	70
CS2000AWF 18 R-T to CS2000AWF 18-30 R-T	100

Table 22 Total volume of water

In most applications, this volume of water will be sufficient; however, in process applications or in environments with high thermal load, additional water may be required.

**i** When the system has zones with remotely controlled valves, the minimum volume of water must be guaranteed even when all valves are closed.

**7.6.1 System pressure and expansion tank control**

The units are equipped with an 8-litre expansion tank (with an available volume of 4.8 litres) which has a pre-charge pressure of 1 bar, sized to suit the total water content of the most common systems.

When serving systems with a high water content, the expansion tank volume may not be sufficient and the pre-charge pressure must be adjusted or an additional expansion tank must be provided.

**7.6.2 Sizes CS2000AWF 4 R-S to CS2000AWF 16 R-S/CS2000AWF 16 R-T**

It is not necessary to adjust the pressure of the standard supplied expansion tank as the water content of the system changes, but it may be necessary to add an additional expansion tank.

Based on the water content of the system, calculate the total volume required for the expansion tank VEXP. VESSEL:

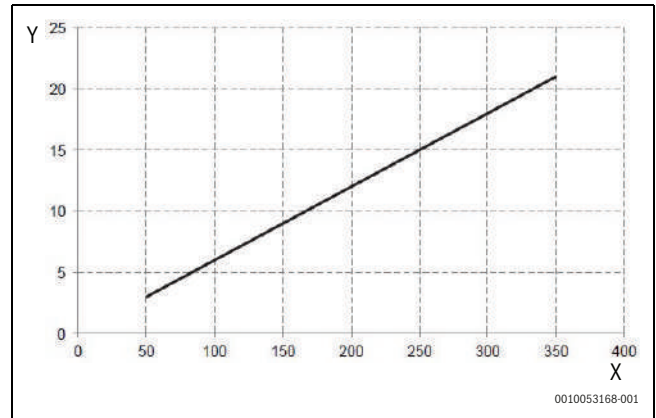

Fig. 55 Total volume for the expansion tank (sizes CS2000AWF 4 R-S to CS2000AWF 16 R-S/CS2000AWF 16 R-T)

X: Water content of the system [l]  
Y: Expansion tank volume [l]

The volume of the additional expansion tank must be:  
 $V_{ADDITIONAL} = V_{EXP. VESSEL} - 4.8$  [l]

**i** The additional expansion tank must be set to 1 bar.

**7.6.3 Sizes CS2000AWF 18 R-T to CS2000AWF 30 R-T**

Depending on the operating conditions, the preset pressure may need to be adjusted on site.

- ▶ Measure the system height difference H.

The difference in height in metres between the highest point of the water circuit and the unit. If the unit is located at the highest point of the system, consider 0m.

Adjust the pressure according to the diagram in the table:

H system height difference [m]	Water content [l]	
	≤ 230	> 230
≤ 7	No adjustment required	The pressure of the expansion tank must be reduce. ▶ Adjust to Pg value.
>7	The pressure of the expansion tank must be increased. ▶ Adjust to Pg value.	The unit's expansion tank is not sufficient, add an additional tank. The pressure of all expansion tanks must be adjusted to the Pg value.

Table 23 Pressure adjustment

The Pg pressure to which the expansion tank should be set can be calculated with the formula:  $P_g = 0.3 + (H/10)$  [bar]



If the expansion tank pressure needs to be adjusted:

- ▶ Contact an authorised technician and use only dry nitrogen. Inadequate expansion tank pressure adjustment can cause the system to malfunction.
- ▶ Check that the system complies with the maximum water content (with standard expansion tank only).

To determine the maximum water content of the system that can be managed with the standard expansion tank alone, use the following graphs:

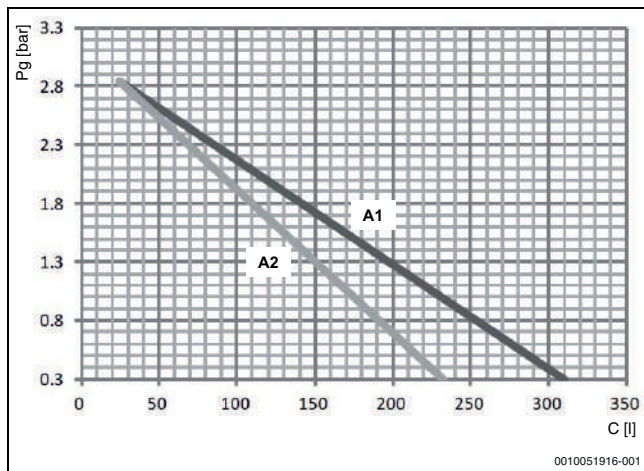

Fig. 56 Maximum water content

- [A1] Water only
- [A2] Water + 25% glycol



The total volume of water in the system must be less than that indicated, otherwise an additional expansion tank will be required.

The additional expansion tank must be adjusted to the Pg pressure and must have a volume sized with the formula:

$$VADD = 0.0693 \times (VSYS / (2.5 \cdot Pg)) - VSTD \text{ [l]}$$

VADD: additional expansion tank volume

VSYS: system water volume

VSTD: volume of the expansion tank supplied with the unit

**Example 1:**

Unit CS2000AWF 16 R-S/CS2000AWF 16 R-T, installed 5m below the highest point of the water circuit → H = 5m

Total volume of water in the water circuit of 150l respects the minimum water content (40l).

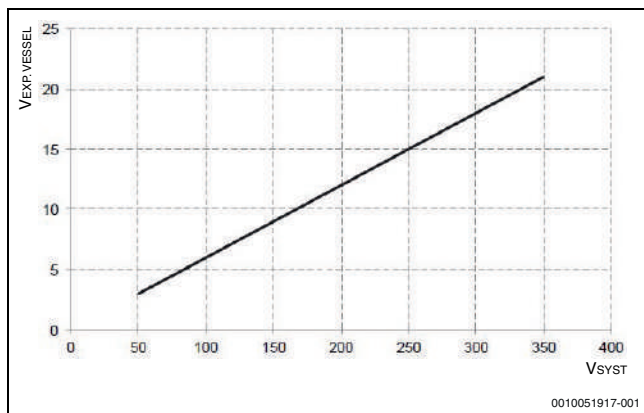

Fig. 57 Example 1

$$VADDITIONAL = VEXP. VESSEL - 4.8 \text{ [l]} = 9 - 4.8 = 4.2 \text{ l}$$

→ additional 4.2l expansion tank required

**Example 2:**

Unit CS2000AWF 22 R-T, installed at the highest point of the water circuit → H = 0m

Total volume of water in the water circuit of 250l

Pg = 0.3 + (0/10) = 0.3 bar respects the minimum water content (60l)

H ≤ 7 m – Water content > 230l

→ expansion tank should be adjusted to the Pg pressure

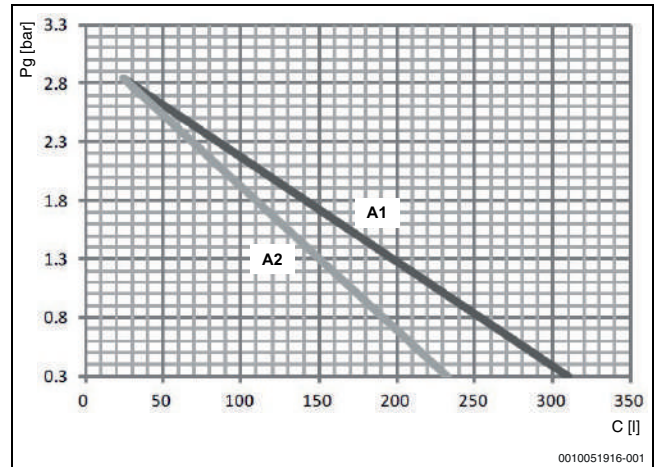

Fig. 58 Example 2

- [A1] Water only
- [A2] Water + 25% glycol

Maximum water content: 310l → respects the maximum water content

**7.7 Filling / topping up with water**

The unit requires the system to be filled with water before start-up or may need to be topped up in special cases. In both cases follow the procedure:

- ▶ Connect the water supply to the filling valve and open the valve.
- ▶ Check that the automatic air vent valve is open (at least 2 turns).
- ▶ Fill with water until the pressure gauge indicates a pressure of approx. 1.8 bar.



Air in the circuit could cause a malfunction of the additional heater:

- ▶ Discharge as much as possible through the vent valve.



If present, the DHW storage tank should only be filled when starting the unit.

When the system is in operation, do not fasten the black plastic cover on the vent valve on the top of the unit.

- ▶ Open the air purge valve, turn at least 2 full turns anticlockwise to discharge air from the system.

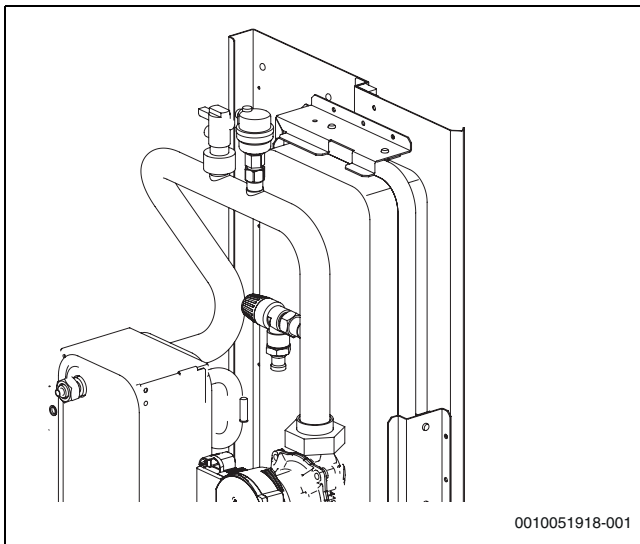

Fig. 59 Filling / topping up with water

During filling, it may not be possible to discharge all the air from the system: the residual air will be discharged through the automatic vent valves during the first hours of system operation.

It may therefore be necessary to top up the system water when the unit is switched off. The water pressure indicated on the pressure gauge varies according to its temperature: water at a higher temperature will have a higher pressure.

- ▶ Keep the water pressure always > 0.3 bar to prevent air from entering the system.

The unit may discharge water through the pressure relief valve.

- ▶ Check the system pressure periodically.

## 8 Electrical connections

- The fixed wiring must include a magnetothermic circuit breaker or other means of isolation with contact separation on all poles, to be implemented in accordance with the laws and regulations in force.
- The protection must be sized in accordance with the electrical data declared by the manufacturer.
- Disconnect the power supply before making any connections and wait 10 minutes so that the DC bus condensers of the compressor's inverter are correctly at a low residual voltage.
- Only use copper cables.
- Do not crush cable bundles and prevent them from coming into contact with pipes and any sharp edges.
- Installation of electrical components and connections on site must be carried out by a qualified electrician and in accordance with the laws and regulations in force.
- On-site electrical connections must be made in accordance with the wiring diagram supplied with the unit and following the instructions below.
- Use a dedicated power supply. Never use a power supply that is also used by other equipment.
- Earth the unit.
- Do not connect the earth wire to gas or water pipes, lightning rods or telephone system earth cables.
- Incorrect earthing may cause electric shocks.
- Install an earth leakage differential circuit breaker (30 mA).
- Failure to observe this precaution may result in electric shock.
- Install the necessary fuses or circuit breakers.
- Power and signal cables should be routed as separately as possible to avoid possible interference. Where ducted in parallel, for convenience observe the following distances: 300 mm for rated

currents below 10 A and 500 mm for rated currents between 10 and 50 A.

### 8.1 Precautions for electrical connections

Follow the precautions below before making electrical connections:

- ▶ Secure electric cables with cable ties so that they do not come into contact with the pipes (especially avoid contact with the refrigeration circuit pipes on the high pressure side).
- ▶ Ensure that no external force is exerted on the terminal connectors.
- ▶ When installing the earth leakage circuit breaker, make sure it is compatible with the inverter (resistant to high frequency electromagnetic interference) to avoid unnecessary tripping of the switch.
- ▶ If a 3-way valve is required in the system, it is advisable to use the kit supplied as an option. However, it is preferable to choose a ball type to ensure complete separation between the domestic hot water circuit and the system circuit. In any case, low-leakage valves should be used. When using a 2- or 3-way valve in the circuit, it is advisable for its maximum switching time to be less than 60 seconds. 30 s switching time is recommended.



The differential circuit breaker must be a 30 mA (<0.1 s) fast tripping type.

This unit is equipped with an inverter. The installation of a power-factor condenser not only disturbs the improving effect that such a device has on the power factor, but can also cause the condenser to overheat due to high-frequency waves.

- ▶ Do not install a power-factor condenser in order to avoid possible accidents.

**8.2 General diagram**

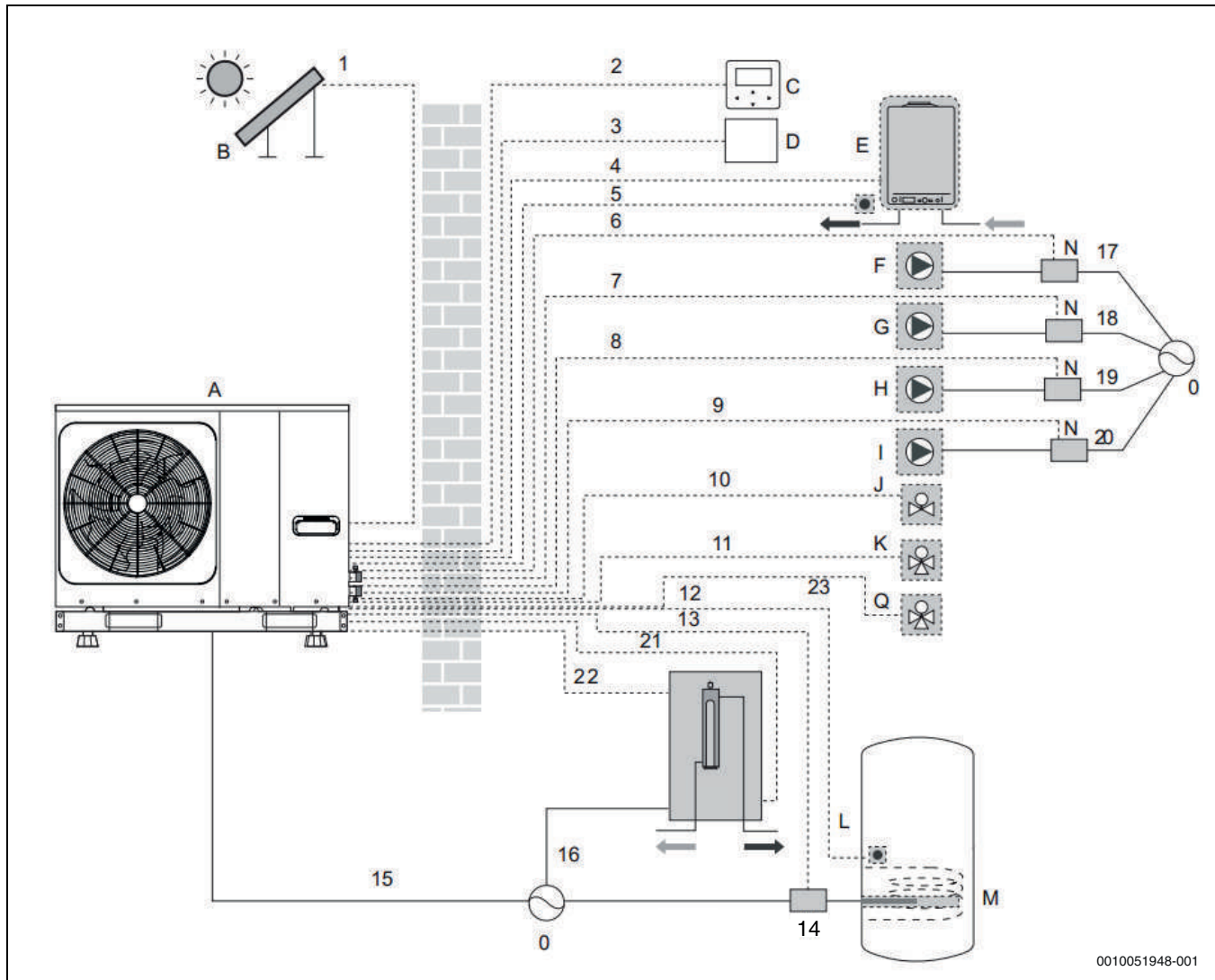

0010051948-001

Fig. 60 General diagram

- [A] Unit
- [B] Solar kit (not supplied)
- [C] User interface
- [D] Room thermostat (not supplied)
- [E] Boiler (not supplied)
- [F] Solar pump (not supplied)
- [G] Mixed zone booster pump
- [H] Zone 1 circulation pump
- [I] DHW recirculation pump (not supplied)
- [J] 3-way valve (not supplied)
- [K] 3-way valve for domestic hot water storage tank (not supplied)
- [L] Domestic hot water storage tank (not supplied)
- [M] Booster heater (not supplied)
- [O] Power supply
- [Q] Zone 2 3-way valve (not supplied)
- [1] Solar kit signal cable
- [2] User interface cable
- [3] Room thermostat cable
- [4] Boiler control cable
- [5] Thermistor cable for Tw2
- [6] Solar pump control cable
- [7] Mixed zone control cable
- [8] Zone 1 pump control cable
- [9] Domestic hot water pump control cable
- [10] 2-way valve control cable/3-way valve control cable
- [11] 3-way valve control cable

- [12] Thermistor cable T5
- [13] Booster heater control cable
- [14] Contactor power supply for domestic hot water storage tank electric heater.
- [15] Unit power cable
- [16] Backup heater power cable
- [17] Solar pump power supply
- [18] Mixed zone booster power supply
- [19] Zone 1 (unmixed) circulation pump power supply
- [20] Domestic hot water circulation pump power supply
- [21] Backup heater consent signal
- [22] Backup heater temperature reading probe
- [23] 3-way valve control cable

 **WARNING**

**High Voltage!**

All cables are connected to high-voltage lines with the exception of the thermistor cable and user interface cable.

- ▶ The appliance must be earthed.
- ▶ All external high-voltage loads, if connected to a metal socket or earthed port, must be earthed.
- ▶ The current required for each external load must be less than 0.2 A. If the current required for a single load is greater than 0.2 A, insert a contactor for control.

As an example, the ports on terminals “AHS1” “AHS2”, “A1” “A2”, “R1” “R1” and “DTF1” “DTF2” only provide the switching signal.

For the location of the ports in the unit → Chapter 8.5.3, page 60.

### 8.3 Control box

#### 8.3.1 Sizes CS2000AWF 4 R-S to CS2000AWF 16 R-S/ CS2000AWF 16 R-T

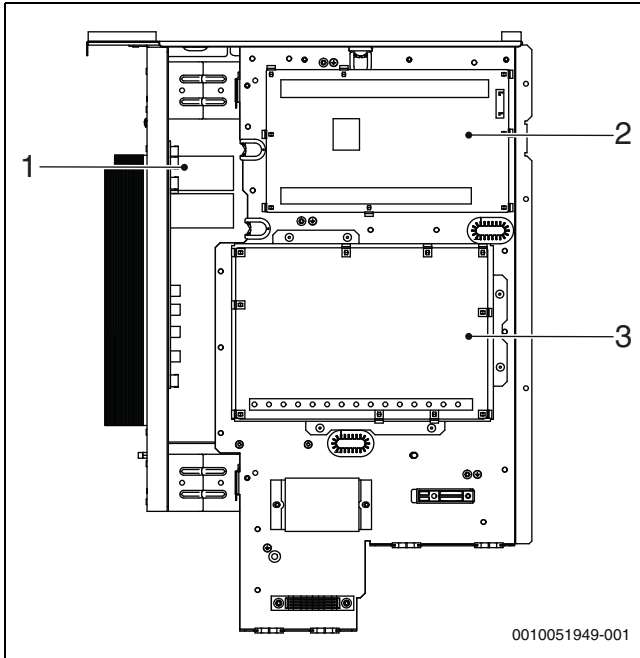

Fig. 61 Sizes CS2000AWF 4 R-S to CS2000AWF 16 R-S/  
CS2000AWF 16 R-T

- [1] Inverter module (PCBA)
- [2] Main control board (PCB B)
- [3] Hydraulic module control board



The picture of the control box is for reference only.

#### 8.3.2 Sizes CS2000AWF 18 R-T to CS2000AWF 30 R-T

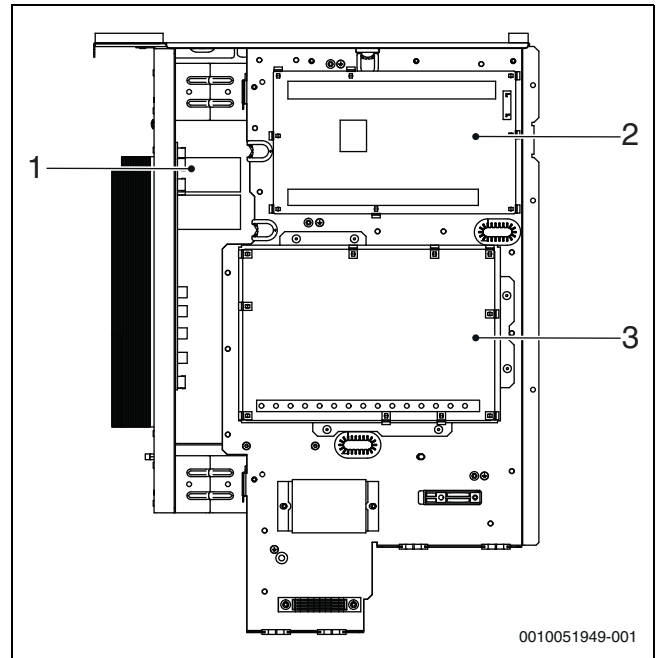

Fig. 62 Sizes CS2000AWF 18 R-T to CS2000AWF 16 R-S/  
CS2000AWF 30 R-T

- [1] Inverter module (PCBA)
- [2] Main control board (PCB B)
- [3] Hydraulic module control board



The picture of the control box is for reference only.

### 8.4 Location of connections

#### 8.4.1 Sizes CS2000AWF 4 R-S to CS2000AWF 6 R-S

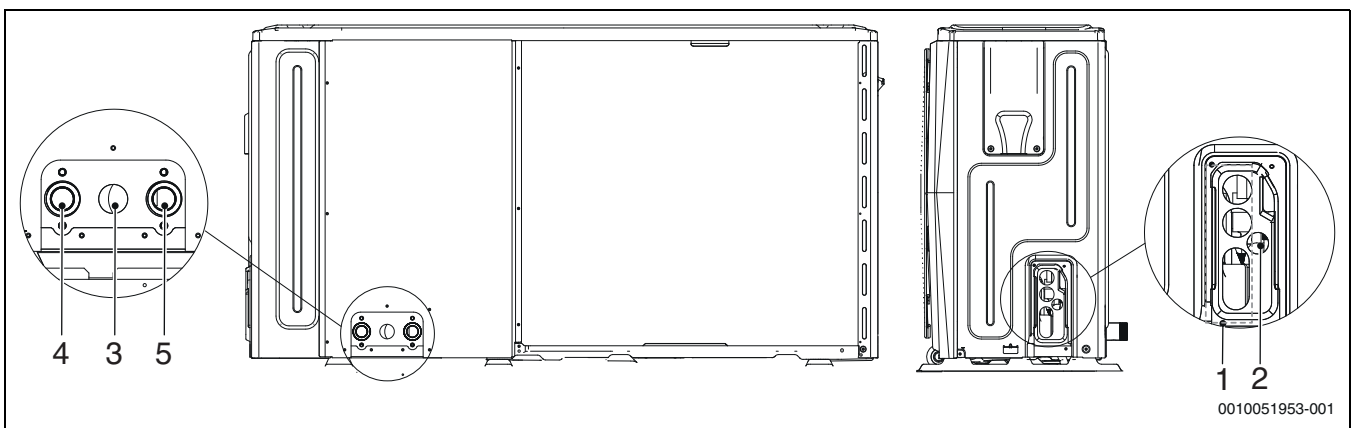

Fig. 63 Sizes CS2000AWF 4 R-S to CS2000AWF 6 R-S

- [1] Hole for high voltage cable (power supply)
- [2] Hole for low voltage cable (control and signal cables)
- [3] Hole for drain pipe
- [4] Water outlet
- [5] Water inlet

**8.4.2 Sizes CS2000AWF 8 R-S to CS2000AWF 16 R-S/CS2000AWF 16 R-T**

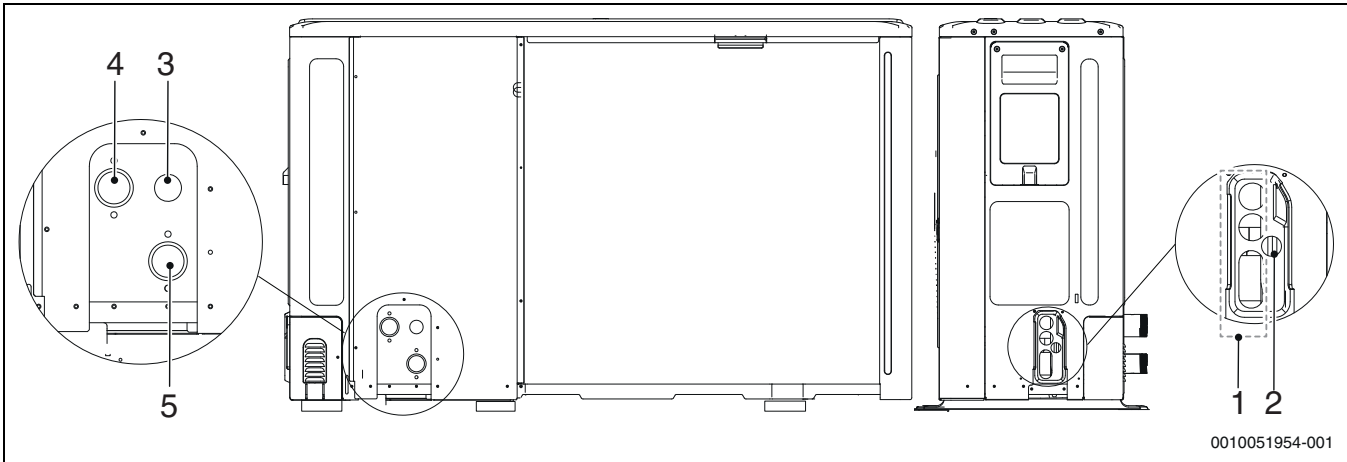

Fig. 64 Sizes CS2000AWF 8 R-S to CS2000AWF 16 R-S/CS2000AWF 16 R-T

- [1] Hole for high voltage cable (power supply)
- [2] Hole for low voltage cable (control and signal cables)
- [3] Hole for drain pipe
- [4] Water outlet
- [5] Water inlet

**8.4.3 Sizes CS2000AWF 18 R-T to CS2000AWF 30 R-T**

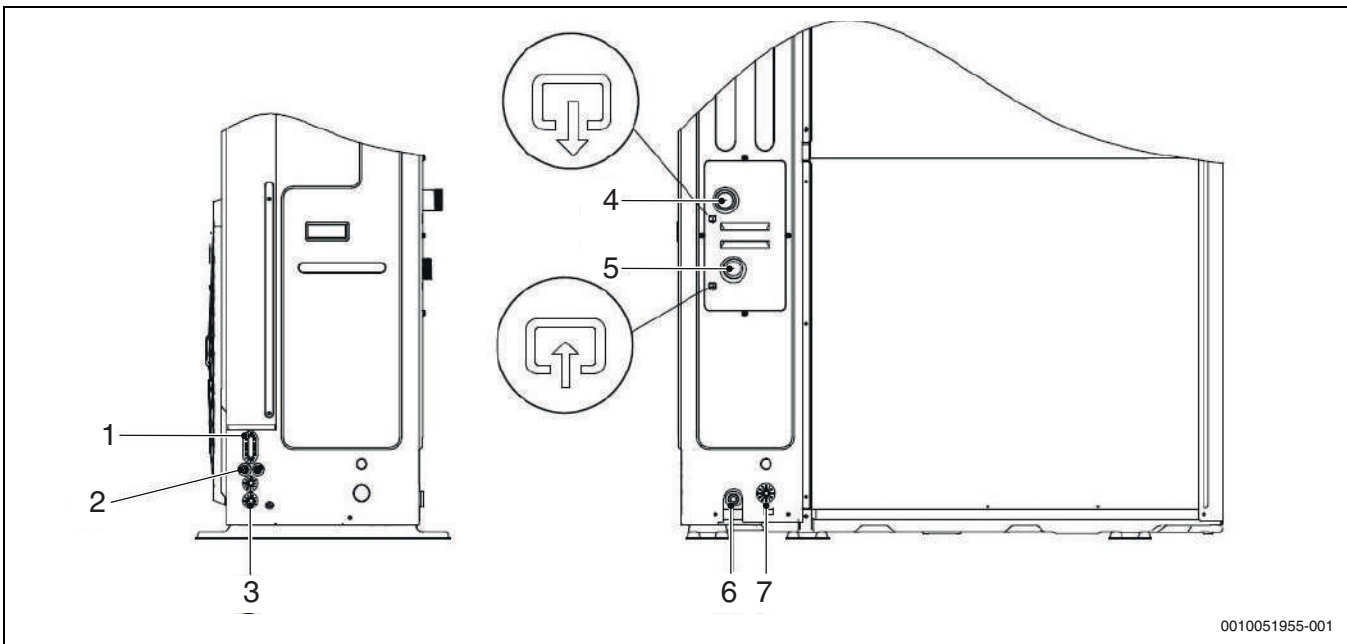

Fig. 65 Sizes CS2000AWF 18 R-T to CS2000AWF 30 R-T

- [1] Hole for high voltage cable (power supply)
- [2] Hole for low voltage cable (control and signal cables)
- [3] Hole for high/low voltage cable
- [4] Water outlet
- [5] Water inlet
- [6] Hole for drain pipe
- [7] Hole for pressure relief valve drain pipe

Most of the electrical connections to be done on site are to be performed on the terminal block inside the control box.

To access the terminal block:



**WARNING**

**High Voltage!**

Before removing the service panel from the control box:

- ▶ Disconnect the power supply to the unit, the backup heater, the domestic hot water storage tank and all the other electrically powered components.

- ▶ Remove the service panel from the control box.
- ▶ Wait 10 minutes for the DC bus condensers of the compressor's inverter to discharge.

**Warning:**

- ▶ Secure cables with cable ties.
- ▶ The external backup heater requires a dedicated electric circuit.

- ▶ Installations with domestic hot water storage tank (available as an option) and external backup heater require a dedicated electric circuit for the booster heater. Refer to the use and installation manual of the domestic hot water storage tank. Secure the electric cables in the order shown below.
- ▶ Lay the electric cables so that the front panel does not lift up during connections and fix the front panel firmly when finished.
- ▶ Connect as shown in the wiring diagrams.
- ▶ Install the wires and fix the panel firmly so that it fits properly.

## 8.5 Electrical connections

### 8.5.1 Precautions when connecting to the power supply

- ▶ Use ring-pressure terminals for connections to the power supply terminal block. If this is not possible for unavoidable reasons, the instructions below should be followed.
- ▶ Do not connect wires of different cross-sections to the same power supply terminal block (Looseness in the power supply wires can cause overheating).
- ▶ When connecting electric wires of the same cross-section, proceed as shown in the figure.

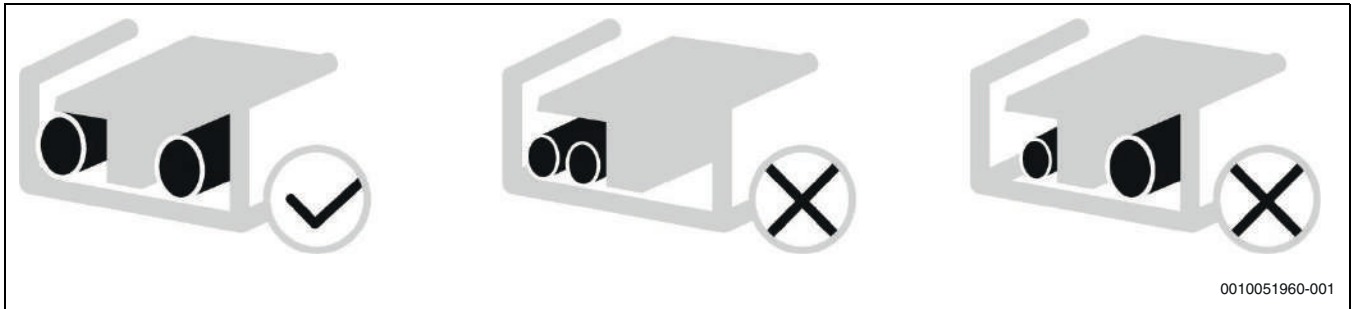

Fig. 66 Precautions when connecting to the power supply

- ▶ Use a suitable screwdriver to tighten the screws on the terminal block. A small-tipped screwdriver could damage the screw head and make tightening impossible.



Over-tightening the screws on the terminal block could damage them.

- ▶ Connect an earth leakage circuit breaker and a fuse or magnetothermic circuit breaker to the power supply line.
- ▶ When making connections, use cables with the required specifications, carry out the connection procedures thoroughly, and secure the wires avoiding external pressure on the terminal connectors.

**Wiring diagram of the electrical control system for the cascade system (3N ~)**

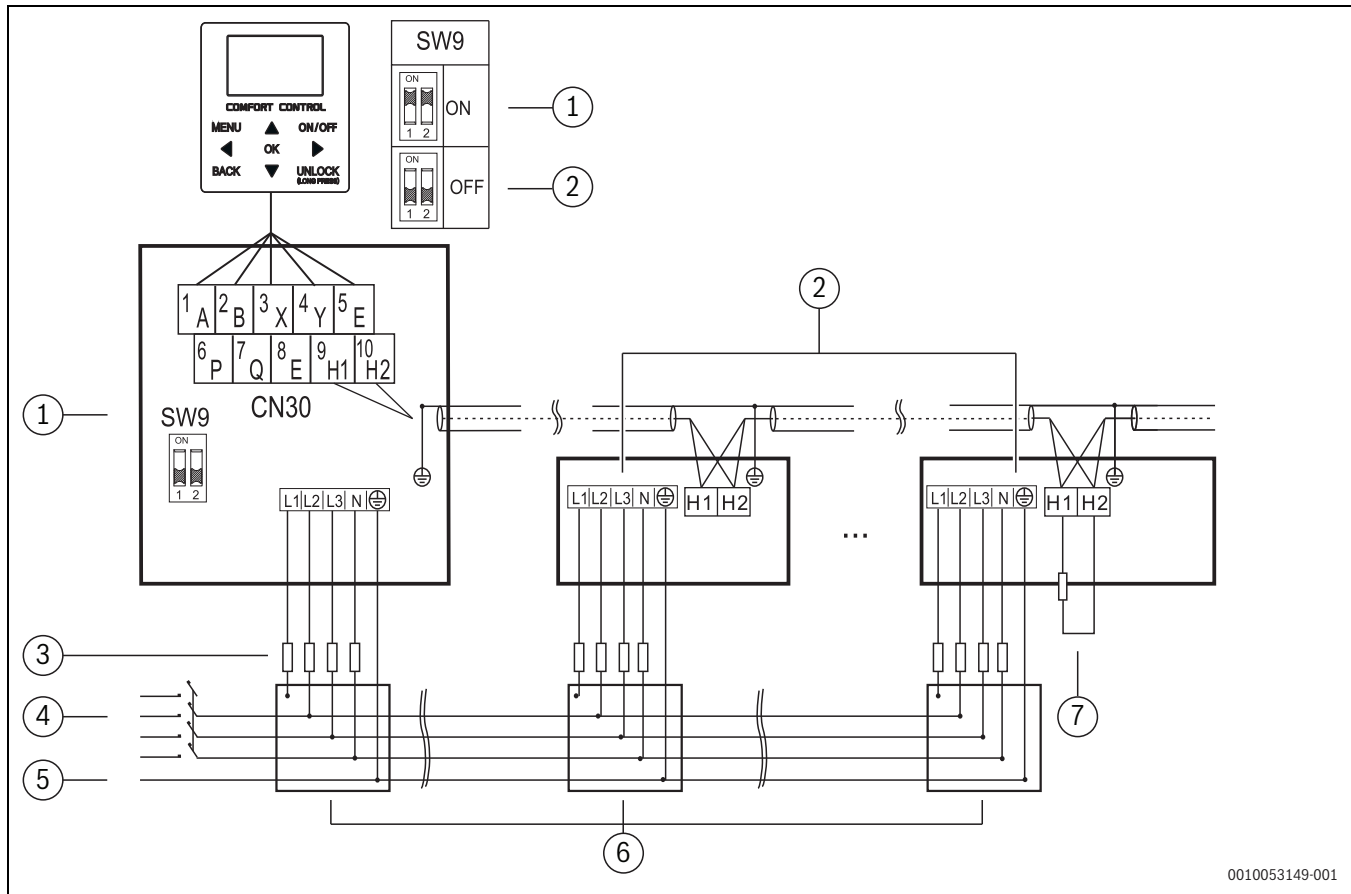

0010053149-001

Fig. 67 Wiring diagram of the electrical control system for the cascade system (3N ~)

- [1] Master unit
- [2] Slave unit
- [3] Fuse
- [4] On/Off switch
- [5] Power supply
- [6] Distributional panel
- [7] External heater

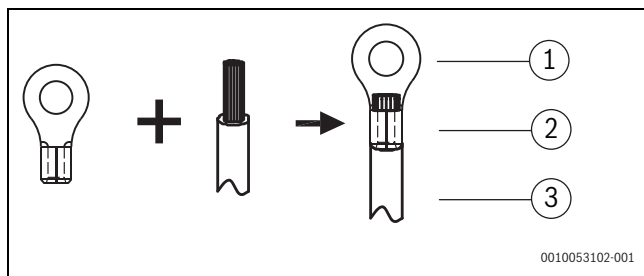

0010053102-001

Fig. 68 Use the circular wiring terminal with the insulating sleeve

- [1] Circular wiring terminal
- [2] Insulation pipe
- [3] Power cable

When connecting to the power supply terminal:

- ▶ Use the circular wiring terminal with the insulating sleeve.
- ▶ Securely connect a power cable that meets the specifications.

To prevent the cable from being pulled by an external force:

- ▶ Ensure that the cable is properly secured.

If it is not possible to use the circular wiring terminal with the insulating sleeve:

- ▶ Make sure it cannot be used.

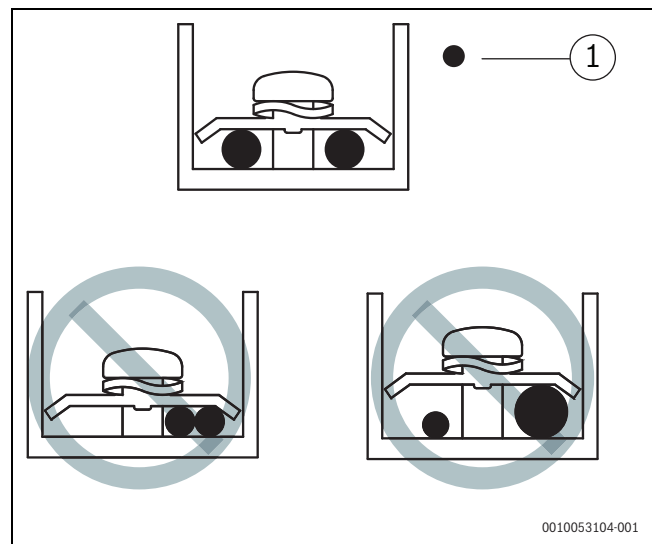

0010053104-001

Fig. 69 Danger of overheating due to loose wiring

- [1] Copper cable

**NOTICE**

**Danger of Overheating!**

The wires could overheat due to loose wiring.

- ▶ Do not connect two power supply cables with different diameters to the same power supply terminal.

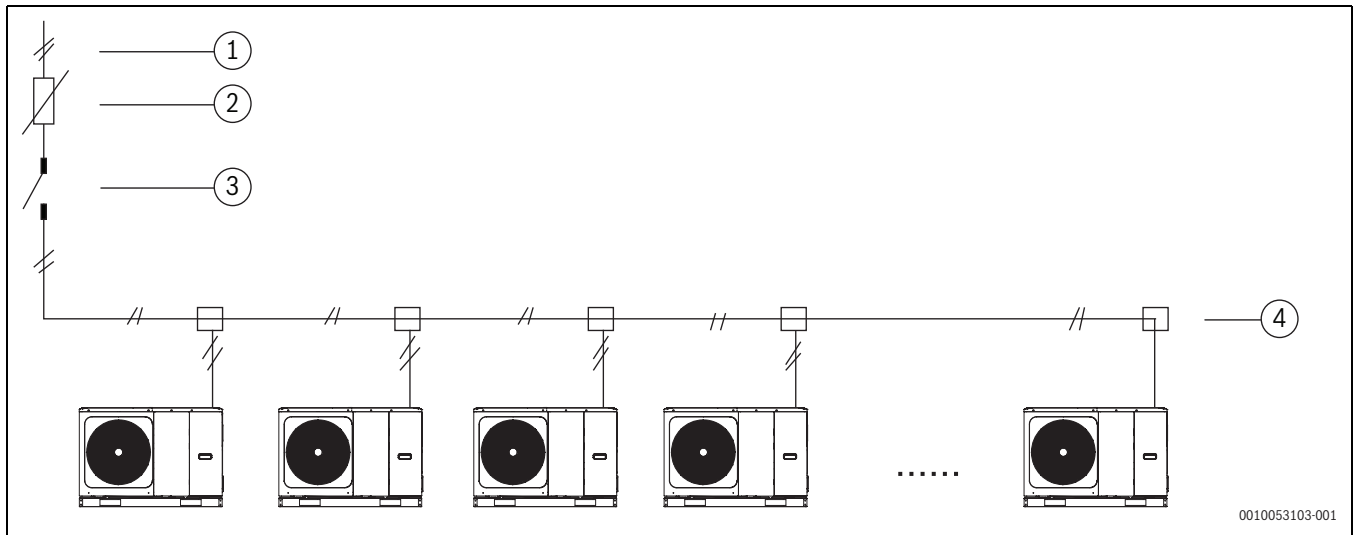

Fig. 70 Electrical Circuit

- [1] Power supply
- [2] Switch
- [3] Manual switch
- [4] Wire distribution box

**8.5.2 Electrical connection specifications**

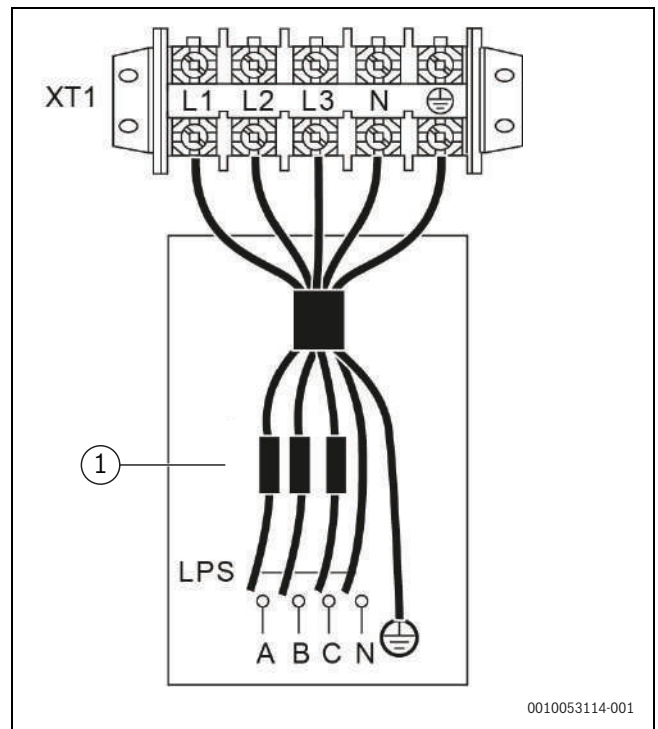

Fig. 71 Compressor compartment and electrical parts: XT1

- [1] Fuse

Size	FLA (A)	Maximum tripping of protections (A)	Cable cross-section (mm <sup>2</sup> )
CS2000AWF 4 R-S	12	25	2.5
CS2000AWF 6 R-S	14	25	2.5
CS2000AWF 8 R-S	16	25	4
CS2000AWF 10 R-S	17	25	4
CS2000AWF 12 R-S/CS2000AWF 12 R-T	25	35	6
CS2000AWF 14 R-S/CS2000AWF 14 R-T	26	35	6
CS2000AWF 16 R-S/CS2000AWF 16 R-T	27	35	6

Table 24

Size	FLA (A)	Maximum tripping of protections (A)	Cable cross-section (mm <sup>2</sup> )
CS2000AWF 12 R-S/CS2000AWF 12 R-T 3~	10	16	2.5
CS2000AWF 14 R-S/CS2000AWF 14 R-T 3~	11	16	2.5

Size	FLA (A)	Maximum tripping of protections (A)	Cable cross-section (mm <sup>2</sup> )
CS2000AWF 16 R-S/CS2000AWF 16 R-T 3~	12	16	2.5
CS2000AWF 18 R-T	21	25	6
CS2000AWF 22 R-T	24.5	25	6
CS2000AWF 26 R-T	27	32	6
CS2000AWF 30 R-T	28.5	32	6

Table 25

**i** The design of the power supply line and its protections is to be provided by the system's electrical designer.  
The design standards differ depending on the country of installation, the length of the lines, the distance to the protection devices and the quality of the power supply.

**i** The minimum cross-section indicated for cables is not necessarily the recommended one.

**i** The values given are maximum values.  
Refer to the electrical data for the exact values.  
For the sizing values of the external protections, refer to the rated electrical data (bill, labels).

**NOTICE**  
**The earth leakage circuit breaker must be a 30 mA (<0.1 s) fast tripping type.**

- Procedure for all connections:
- ▶ Connect the cable to the appropriate terminals as shown in the diagram.
  - ▶ Secure the cables with cable ties at the appropriate attachment points to prevent tension.

**8.5.3 Connection Terminal Block**

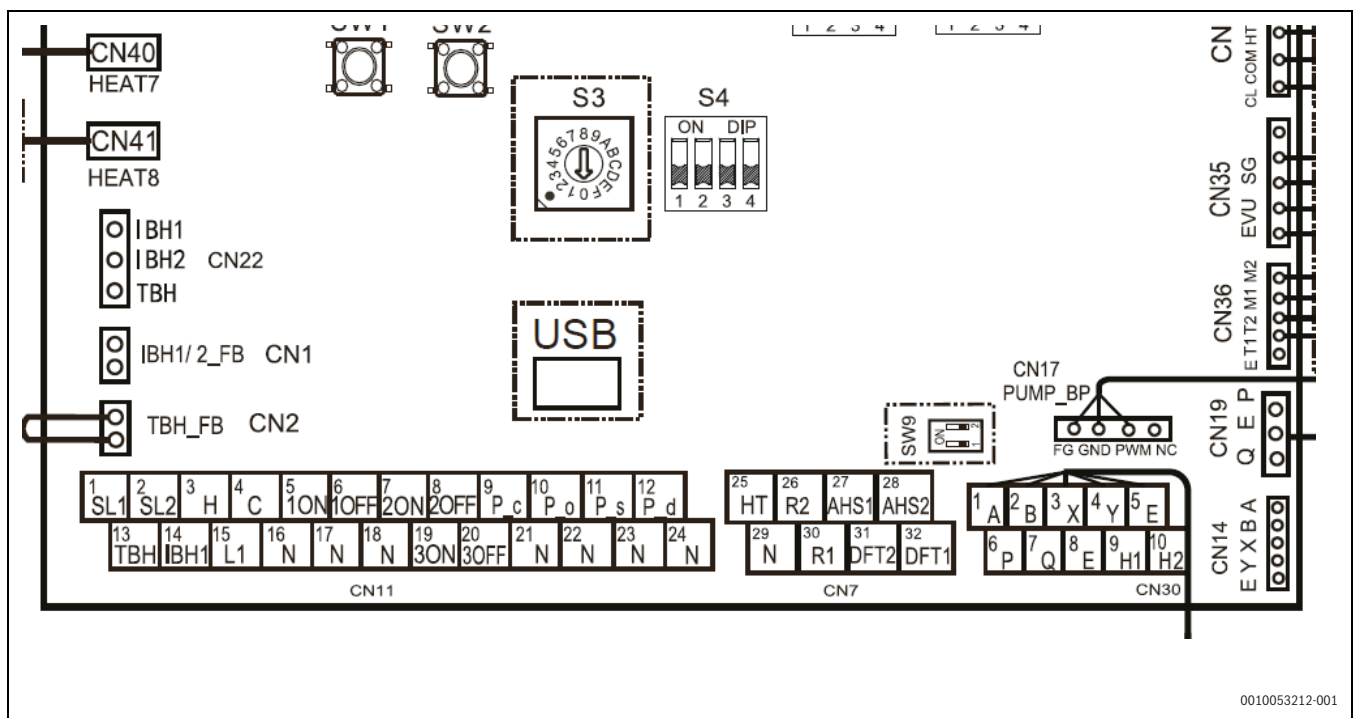

Fig. 72 Connection Terminal Block

Ref.	Terminal block CN11		
1	1	SL1	Solar input
	2	SL2	
2	3	H	Room thermostat (220V)
	4	C	
	15	L1	
3	5	1ON	SV1 DHW 3-way valve
	6	1OFF	
	16	N	

Ref.	Terminal block CN11		
4	7	2ON	SV2 3-way zone valve
	8	2OFF	
5	17	N	pump P_c (zone2)
	9	P_c	
6	21	N	pump P_o (zone1)
	10	P_o	
		22	N

Ref.	Terminal block CN11		
7	11	P_s	solar pump
	23	N	
8	12	P_d	DHW recirculation pump
	24	N	
9	13	TBH	TBH heater
	16	N	
10	14	IBH1	External backup heater
	17	N	
11	17	N	SV3 zone 2 3-way mixing valve
	7	ON	
	19	OFF	

Table 26 Terminal block CN11

Ref.	Terminal block CN7		
1	26	R2	Unit in operation signal
	30	R1	
	21	DFT2	Defrosting state or alarm state
	32	DFT1	
2	25	HT	Antifreeze heater for pipes
	29	N	
3	27	AHS1	Additional boiler
	28	AHS2	

Table 27 Terminal block CN7

Ref.	Terminal block CN30		
1	1	A	Wired controller
	2	B	
	3	X	
	4	Y	
	5	E	
2	6	P	Reserved
	7	Q	
3	9	H1	M/S connection for units in cascade
	10	H2	

Table 28 Terminal block CN30

Other terminal blocks		
CN31	CL	zone thermostat (12V)
	COM	
	HT	
	GND	
CN35	EVU	boiler management signal (0-10V)
	DF	
CN36	EVU	smart grid and photovoltaic inputs
	SG	
CN36	M1	Remote ON/OFF
	M2	

Table 29 Other terminal blocks

Temperature probes		
CN6	T1	additional heat source
CN24	Tbt1	hydraulic separator
CN16	Tbt2	not used
CN13	T5	DHW boiler
CN15	Tw2	mixed zone supply
CN18	Tsolar	solar thermal

Table 30 Temperature probes

**TYPE 1 control signal**

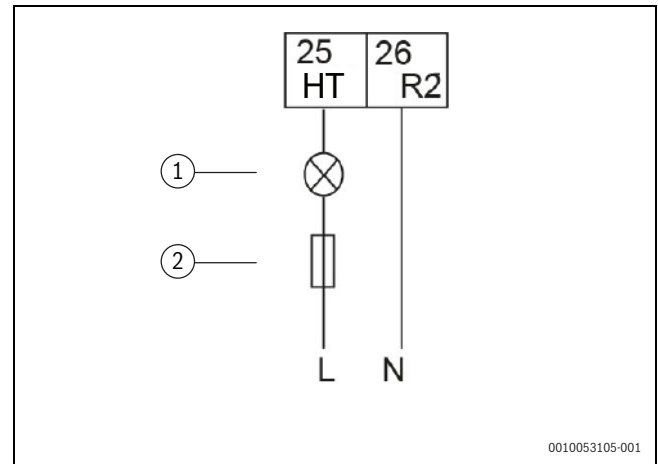

Fig. 73 TYPE 1 control signal

- [1] Load
- [2] Fuse
- Potential-free contact

**TYPE 2 control signal**

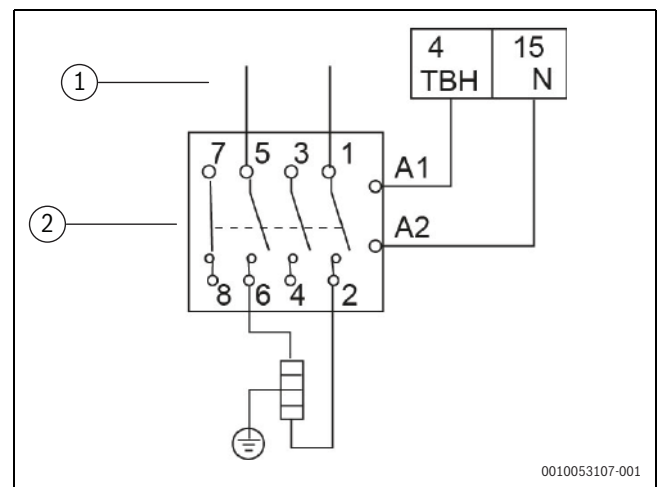

Fig. 74 TYPE 2 control signal

- [1] Power supply
- [2] Contactor

The port provides the signal with a voltage of 220 V  
 Cable cross-section: 0.75 mm<sup>2</sup>  
 If the load current is <0.2A, the load can be connected directly to the port.  
 If the load current is ≥ 0.2A, the AC contactor must be connected for the load.

## 8.6 Terminal block connection specifications

### 8.6.1 Terminal block CN11

#### Solar/Solar pump input

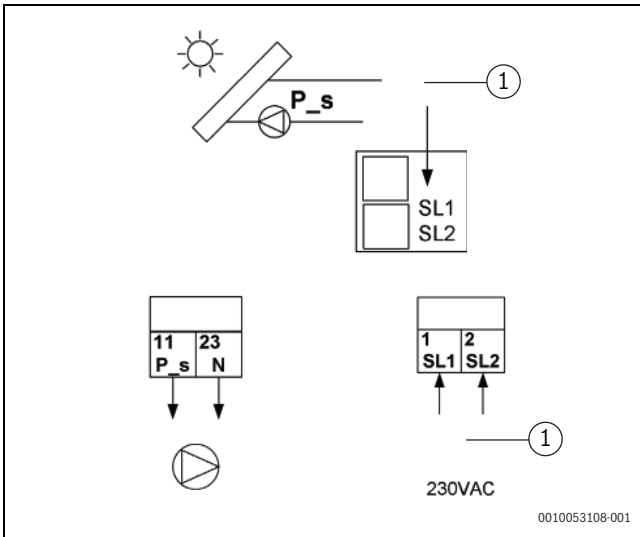

Fig. 75 Solar/Solar pump HMI configuration

[1] Solar station control

[P\_s] Solar pump

#### Domestic hot water

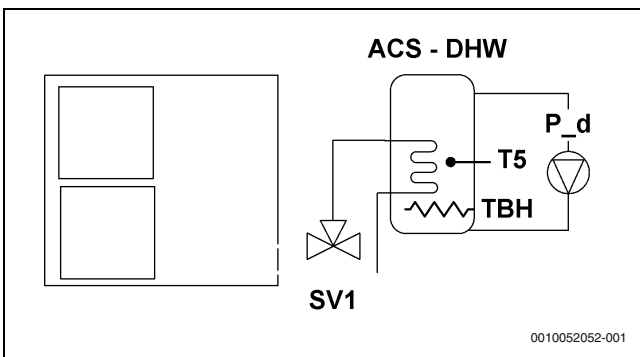

Fig. 76 Domestic hot water

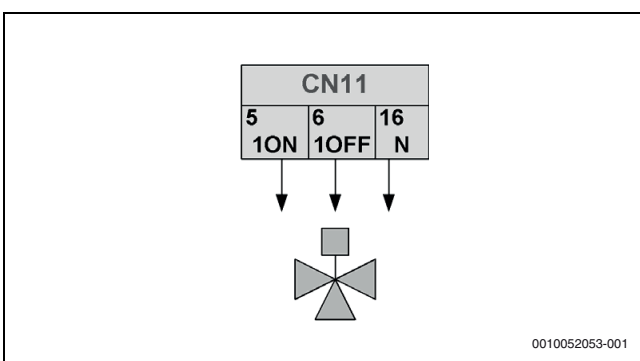

Fig. 77 3-way valve SV1, type 2 control signal

The electrical connection of the 3-way valve (SV1 - 3-way valve) is different for NC (normally closed) and NO (normally open) valves.

Before connection:

- Read the 3-way valve use and installation manual carefully and install the valve as shown in the figure 77.
- Pay attention to the connection terminal numbers.

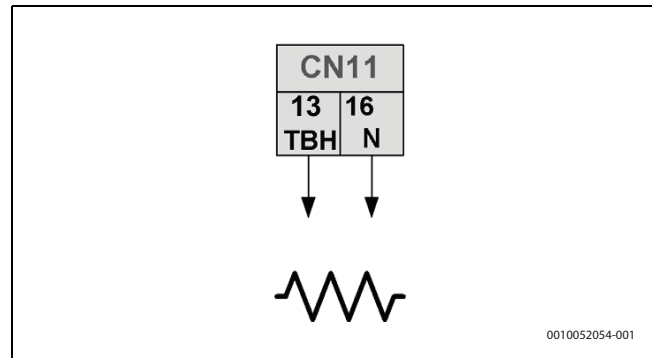

Fig. 78 Booster heater cable HMI configuration, type 2 control signal

[TBH] DHW tank booster heater

- Connect probe T5

The connection of the booster heater cable (TBH heater) depends on the type of application. This connection is only required when a domestic hot water storage tank is installed.

The unit only sends a switch-on/off signal to the booster heater. An additional circuit switch and a dedicated terminal block are required to power the booster heater.

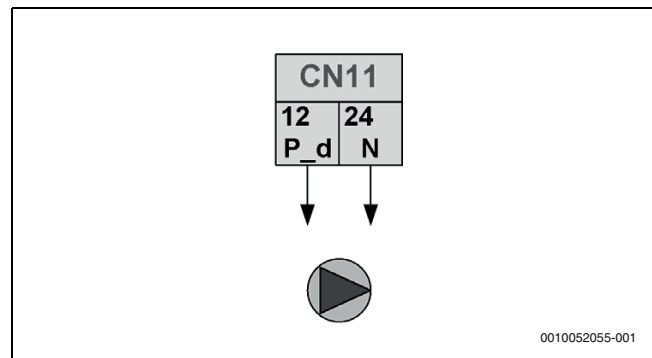

Fig. 79 DHW pump, type 2 control signal

[P\_d] DHW circulation pump

#### Double zone system

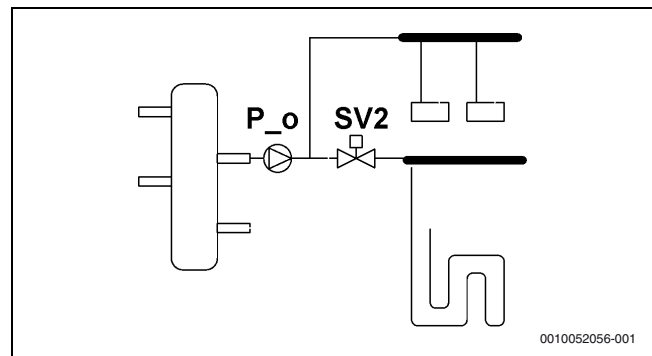

Fig. 80 Double zone system

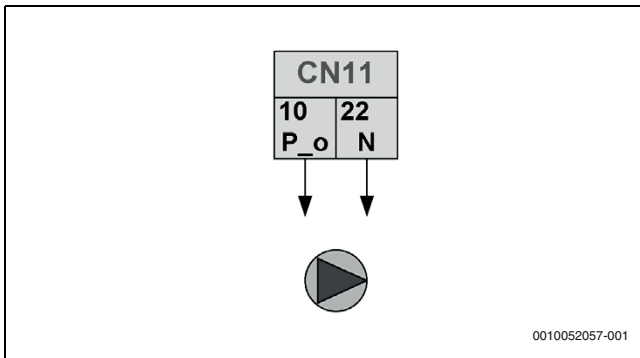

Fig. 81 External pump, type 2 control signal  
[P\_o] Secondary circuit pump (zone 1)

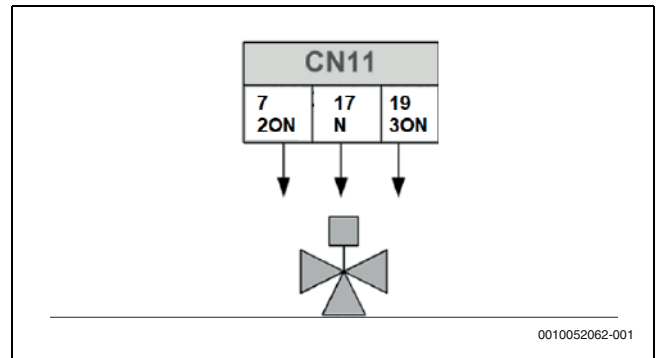

Fig. 85 3-way valve SV3, type 2 control signal

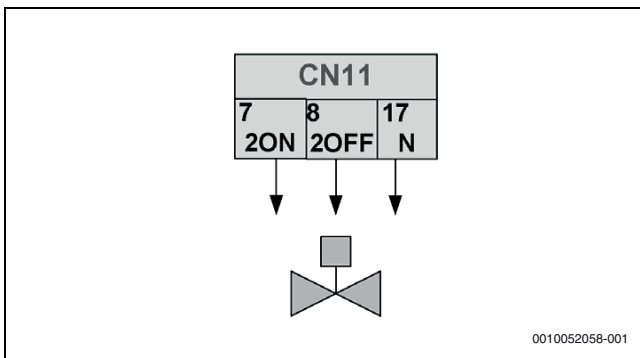

Fig. 82 SV2 2-way valve HMI configuration

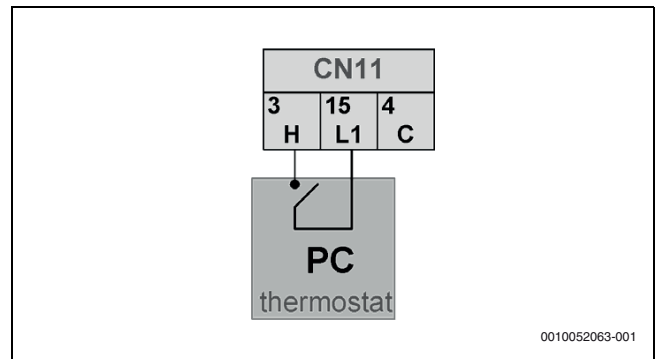

Fig. 86 Room thermostat HMI configuration

**Double zone mixed system**

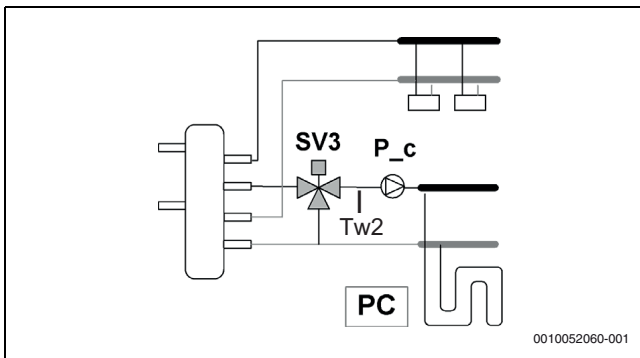

Fig. 83 Double zone mixed system

**External backup heater**

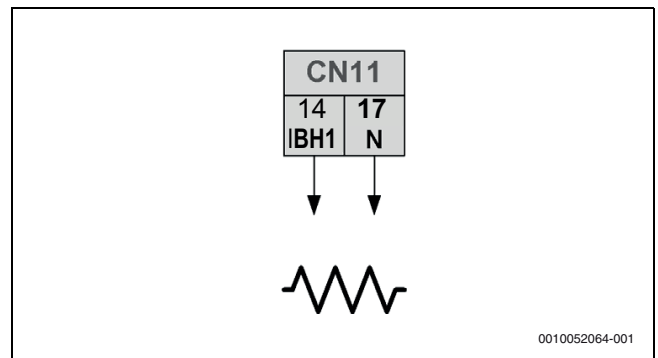

Fig. 87 External backup heater

Enabling on dip-switch; configuration on HMI board of indoor unit

**8.6.2 Terminal block CN7**

**Unit in operation signal**

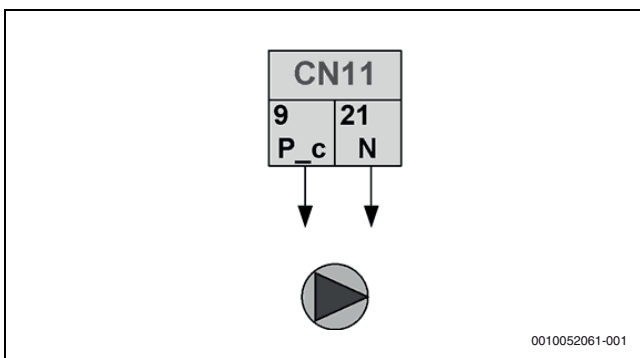

Fig. 84 Zone 2 mixing pump, type 2 control signal  
[P\_c] Pump

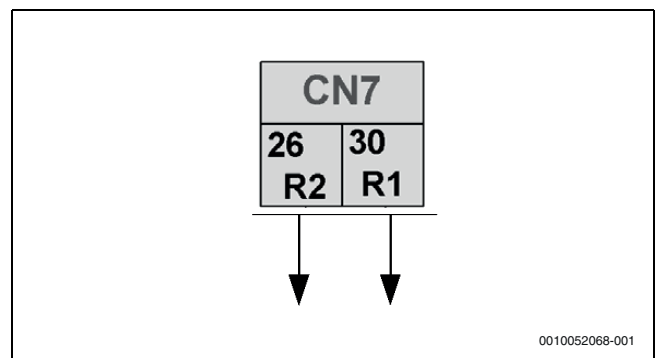

Fig. 88 Unit in operation signal  
Type2 control signal

**Defrosting state or alarm state**

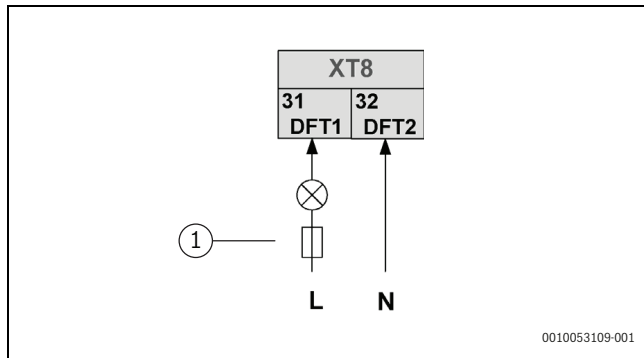

Fig. 89 Defrosting state or alarm state

Type1 control signal  
Enabling and configuration on HMI

**Antifreeze heater for pipes**

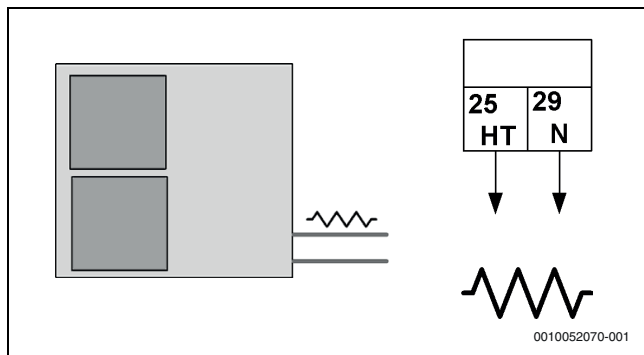

Fig. 90 Antifreeze heater for pipes

Type2 control signal  
Not applicable

**Additional boiler**

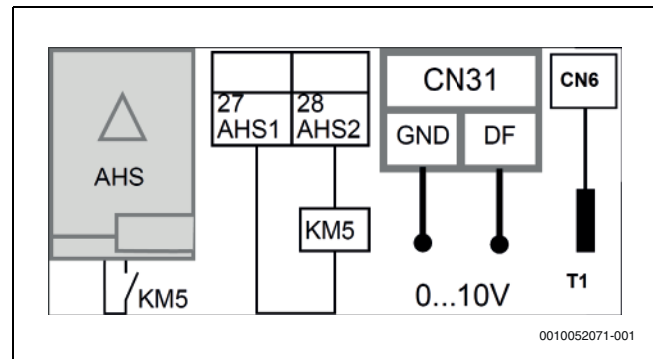

Fig. 91 Additional boiler

The boiler can be controlled in two ways:

- ON-OFF control: The setpoint must be set on the boiler keypad
- ON-OFF consent + 0-10 V signal: The setpoint is managed directly by the unit

Enabling on dip-switch; configuration on HMI  
Connect probe T1, boiler input, optional.



Where HMI enabling is required, refer to the specific chapter.

**8.7 SMART GRID - Photovoltaic management**

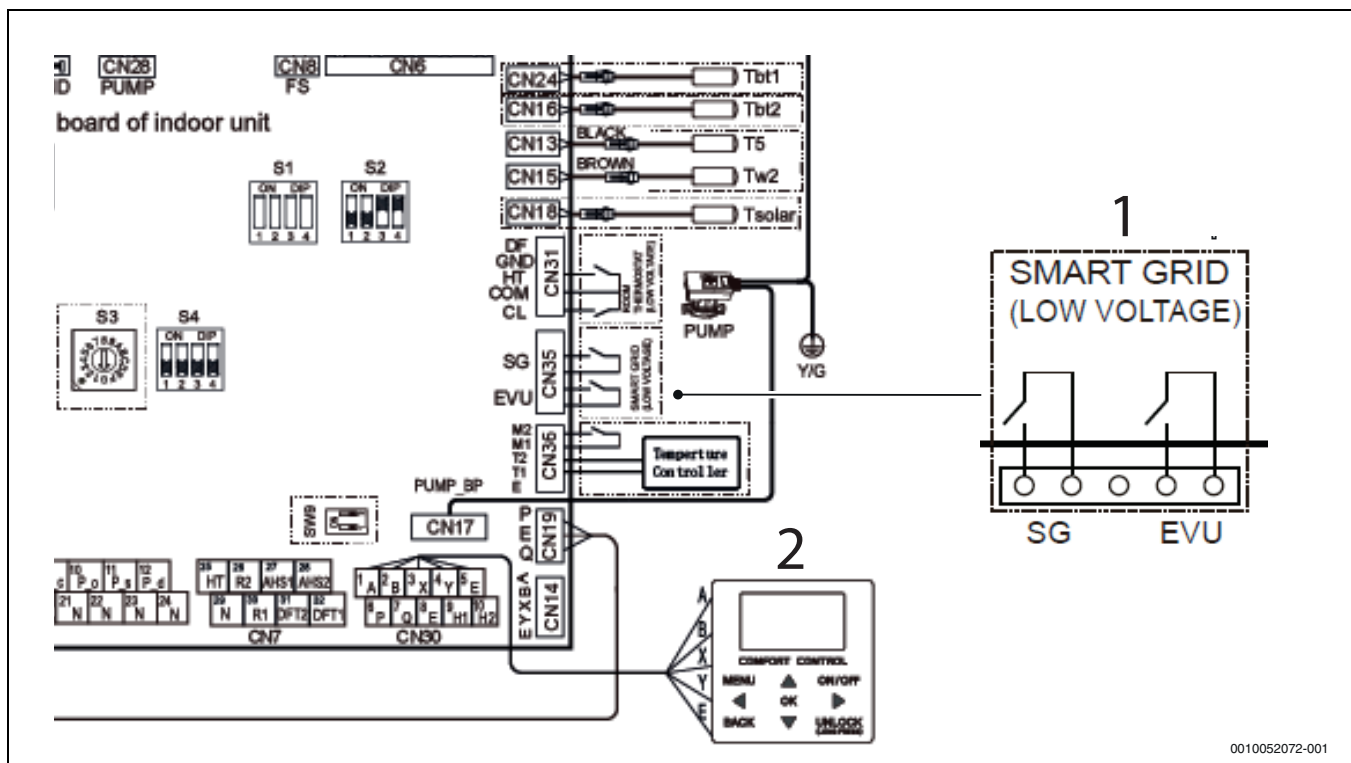

Fig. 92 SMART GRID - Photovoltaic management

Description	EVU Photovoltaic signal	SG Smart grid
The unit operates normally	OFF	OFF
The unit is switched off	OFF	ON

Description	EVU Photovoltaic signal	SG Smart grid
The unit is forced into DHW, even if switched off, with setpoint = T5S + 3 °C	ON	OFF
The unit is forced into DHW with setpoint T5S = 60 °C, if switched off; or with setpoint T5S = 70 °C.	ON	ON

Table 31 SMART GRID - Photovoltaic management

### 8.8 Dip-switch setting

The dip-switches are located on the main control board of the hydraulic module.

Switch			
S1	3.4		IBH and AHS absent = 3 Off, 4 Off IBH present = 3 On, 4 Off (if with built-in heater: factory setting; if with external heater: setting on site) AHS only Heating = 3 Off, 4 On AHS Heating and DHW = 3 On, 4 On
S2	1		Recirculation every 24H on secondary circuit disabled = 1 On Recirculation every 24H on secondary circuit enabled = 1 Off
	2		TBH absent = On TBH present = Off
	3.4		Reserved
S4	1		If the units are in cascade, they are auto-addressing. If auto-addressing fails: <ul style="list-style-type: none"> <li>▶ Switch off power supply.</li> <li>▶ Set 1 = ON and switch on power supply.                             <ul style="list-style-type: none"> <li>- If the unit is configured as the Master: it deletes the addresses present in all Slave units</li> <li>- If the unit is configured as a Slave: it deletes its own address</li> </ul> </li> <li>▶ Switch off power supply and set 1 = OFF.</li> <li>▶ Switch on power supply.</li> </ul> The auto-addressing procedure of the Slave units is restarted.
	2		IBH enabled for DHW production = On IBH disabled for DHW production = Off
	3.4		3: ON: the unit is a back-up Master, OFF: the unit is not a back-up Master 4: Reserved
S9	1.2		Configuration of units in cascade: <ul style="list-style-type: none"> <li>• Slave = 1 Off, 2 Off</li> <li>• Master = 1 On, 2 On</li> </ul>

Table 32 Dip-switch setting

## 8.9 User interface



This appliance supports the MODBUS RTU communication protocol.

- ▶ Connect a shielded wire to earth.
- ▶ Refer to the attached documentation for more information.

The user interface can also be used as a room thermostat.

- ▶ For configuration see Chapter 9, page 72.

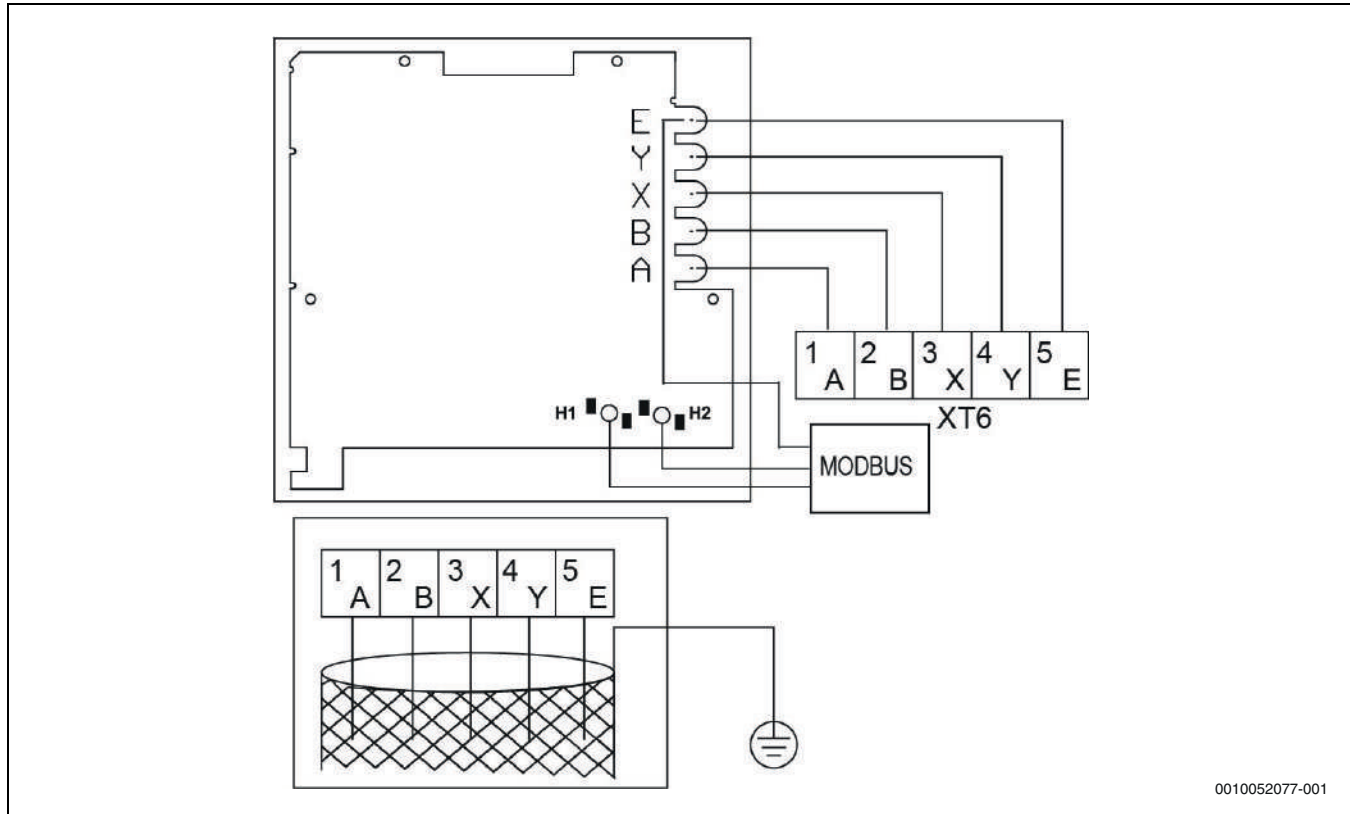

Fig. 93 User interface

Component	Type
Cable	5-wire shielded
Cable cross-section (mm <sup>2</sup> )	0.75 ~ 1.25
Maximum cable length (m)	50
Input voltage (A/B)	13.5 VAC

Table 33 User interface

### 8.9.1 User interface installation requirements

#### NOTICE

#### Damage to the product and malfunction due to environment!

- ▶ Do not install in environments with a strong presence of oil, steam or gaseous sulphides.
- ▶ Check that all the components listed below are present.
- ▶ The wired remote control circuit is low voltage. It should not be connected to a normal 220V/380V circuit, nor should it be placed in the same wiring duct as such a circuit.
- ▶ The shielded cable must be firmly earthed otherwise transmission problems may occur.
- ▶ Do not cut the shielded cable to connect it to an extension lead. Use a terminal block if necessary.
- ▶ Do not use a megger to check the insulation of the signal wire when the connection is completed.

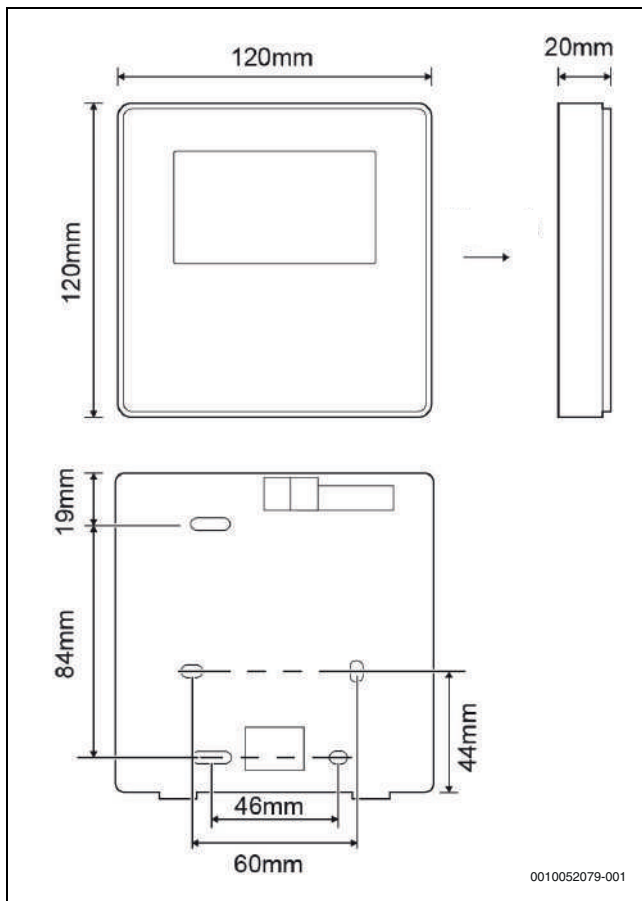

Fig. 94 User interface installation

Name	Quantity	Notes
Wired controller	1	
Phillips round head wood screw	3	For wall assembly

Name	Quantity	Notes
Phillips round head screw	2	For electrical box assembly
Use and installation manual	1	
Plastic bolt	2	This accessory is used to install the central control unit inside the control box.
Plastic expansion plug	3	For wall assembly

Table 34 User interface installation requirements

**Installing the back cover**

- ▶ Insert a flat screwdriver into the indentation at the bottom of the wired controller and pry the back cover off.



Pry off in the correct direction, otherwise the back cover risks being damaged

- ▶ Use three M4X20 screws to install the back cover directly on the wall.
- ▶ Use two M4X25 screws to install the back cover on the electrical box 86.
- ▶ Use one M4X20 screw to secure it to the wall.
- ▶ Adjust the length of two plastic screw bars supplied as accessories to the standard distance between the screw bar of the electrical box and the wall.
- ▶ Install the screw bar on the wall so that it is flush with the wall.
- ▶ Fix the back cover of the wired controller to the wall by inserting the Phillips screws into the screw bar.
- ▶ Check that the back cover of the wired controller is at the same level after installation.
- ▶ Reinstall the wired controller on the back cover.



Over-tightening the screw will buckle the back cover.

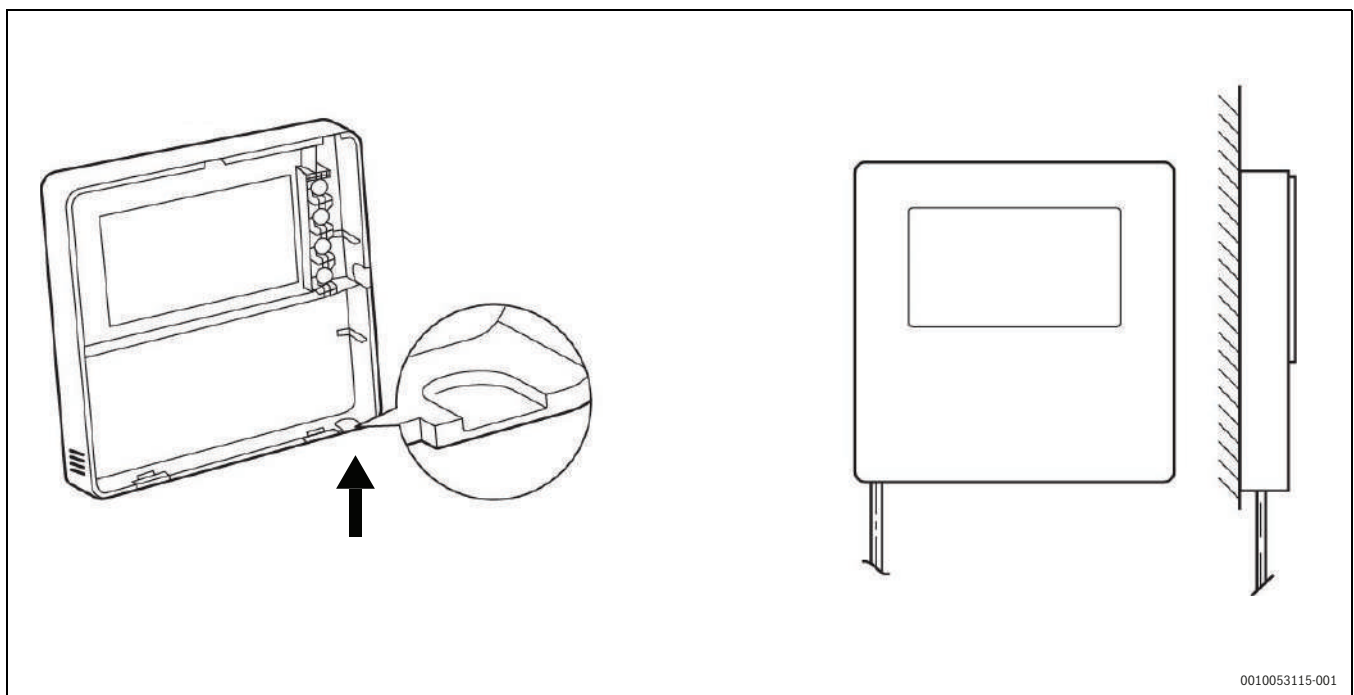

Fig. 95 Positioning of the cable outlet

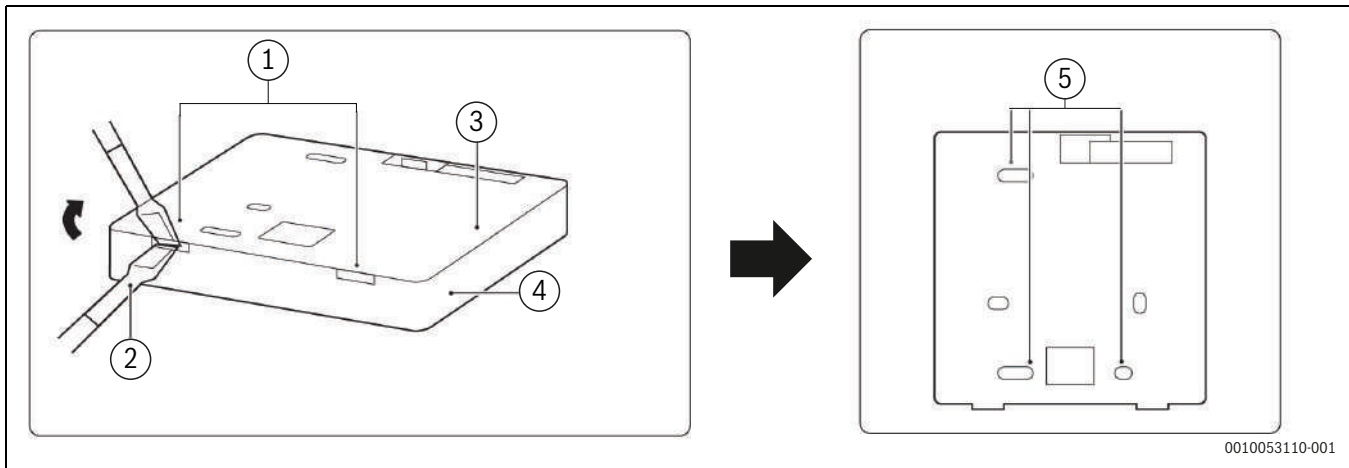

Fig. 96 Wall installation

- [1] Leverage point
- [2] Usage of flat screwdriver to open the back cover
- [3] Back cover
- [4] Front cover
- [5] Three holes for M4X20 wall screw use

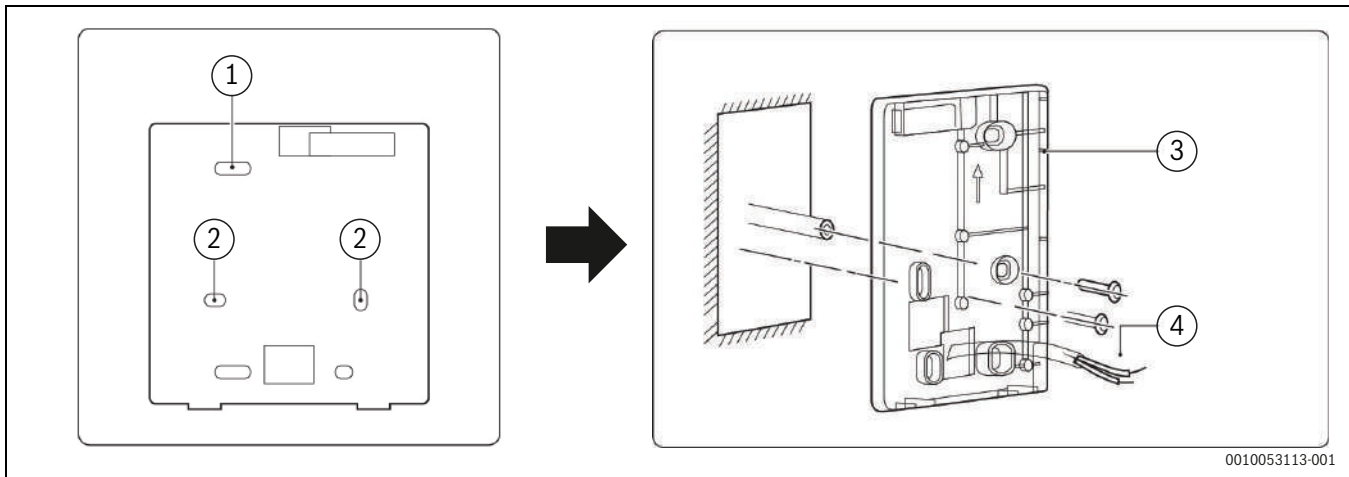
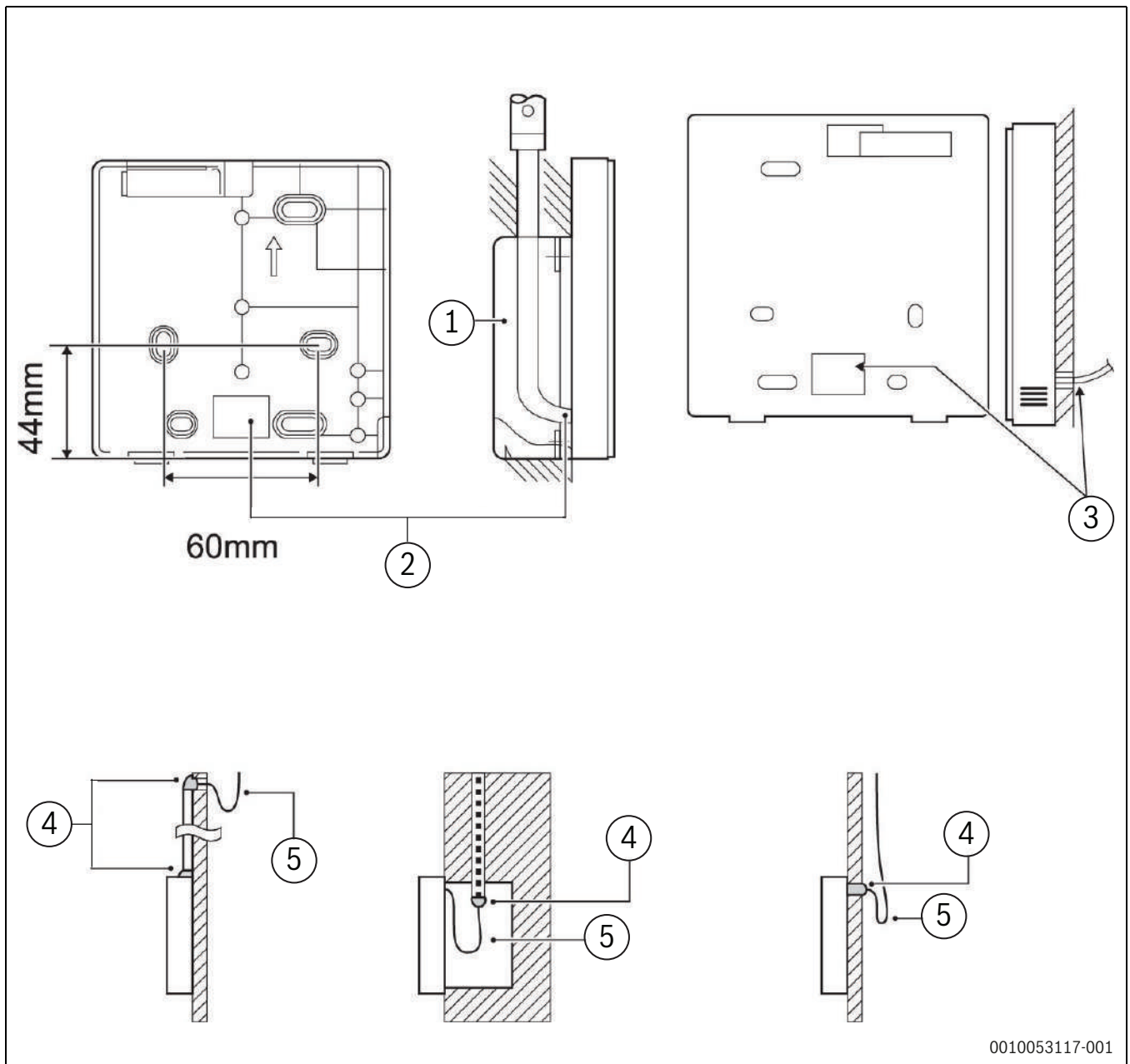

Fig. 97 Installation in electrical box 86

- [1] 3 holes for M4X20 screws, for wall installation
- [2] 2 holes for M4X25 screws, for installation of electrical box 86
- [3] Back cover
- [4] Signal cables



Prevent water from entering the wired controller, use siphons and mastic to seal the wire connectors during installation.



0010053117-001

Fig. 98 Use siphons and mastic

- [1] Electrical box
- [2] Cable holes
- [3] Cable hole  $\varnothing 8 - \varnothing 10$
- [4] Mastic
- [5] Siphon

**Installing the front cover**

- ▶ Adjust and then secure the front cover.
- ▶ Do not crush the communication wire during installation.



The sensor must not be exposed to humidity.

- ▶ Install the back cover correctly and attach the front cover firmly to it (otherwise the front cover may fall off).

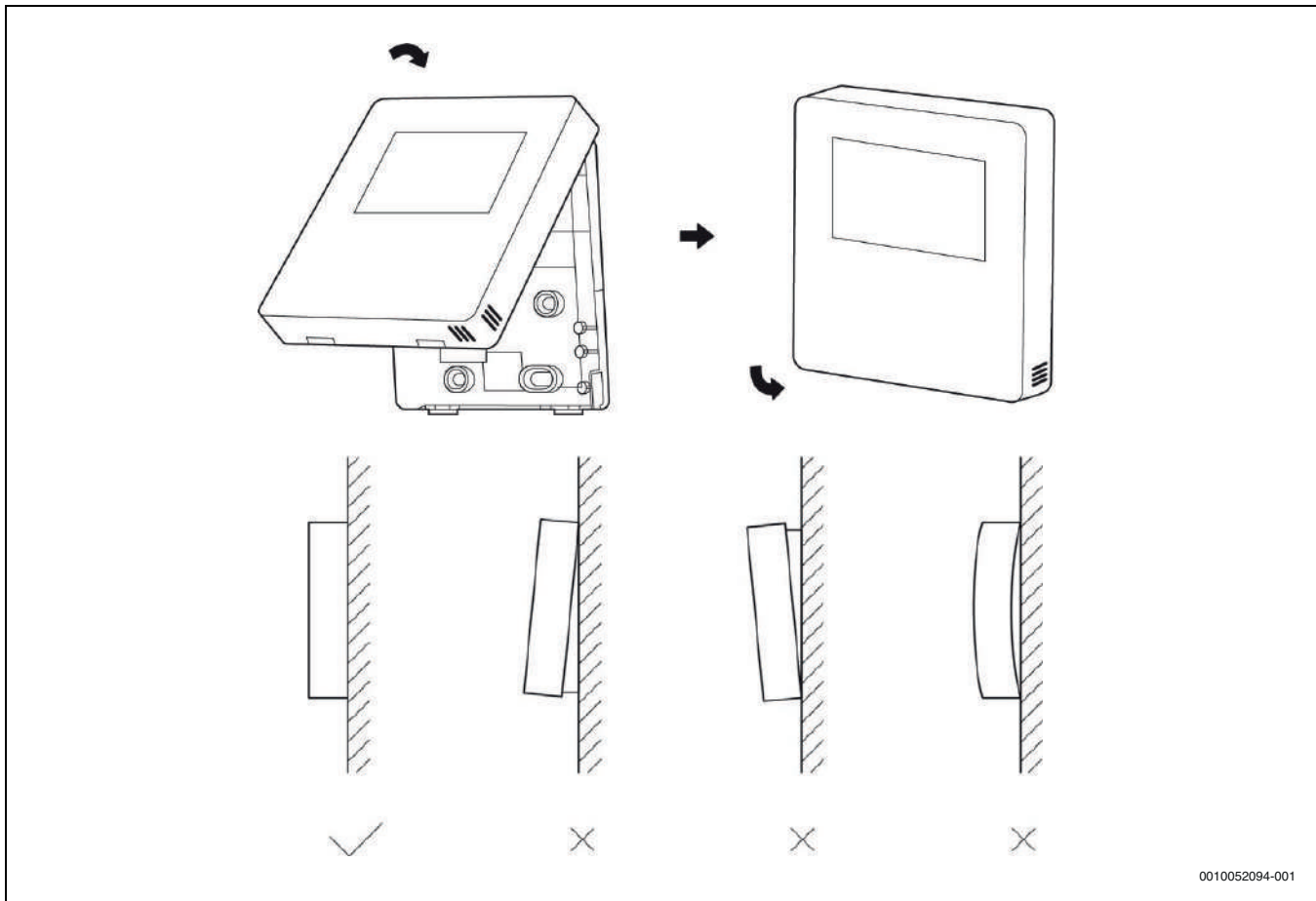

Fig. 99 Installing the front cover

0010052094-001

### 8.10 Zone thermostat

The zone thermostat (to be supplied separately: use the Manufacturer's accessory or equivalent) can be connected in three different ways. The choice of which one to use depends on the type of application.

#### Method A

One zone system with zone thermostat managing the unit's ON/OFF and mode change.

User interface setting:  
THERMOSTAT and CAMERA MODE SETTING on YES  
HMI setting:  
ROOM THERMOSTAT = MODE SET

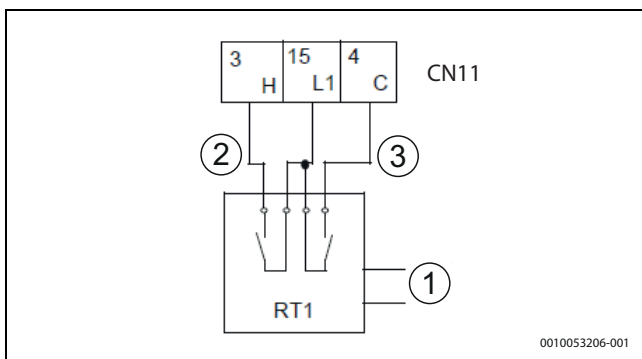

Fig. 100 Zone thermostat – Method A

- [1] Power in
- [2] Heat
- [3] Cool

#### Method B

One zone system with zone thermostat managing only ON/OFF, user interface managing the unit's mode change.

User interface setting:  
THERMOSTAT and CAMERA MODE SETTING on YES  
HMI setting:  
ROOM THERMOSTAT = ONE ZONE

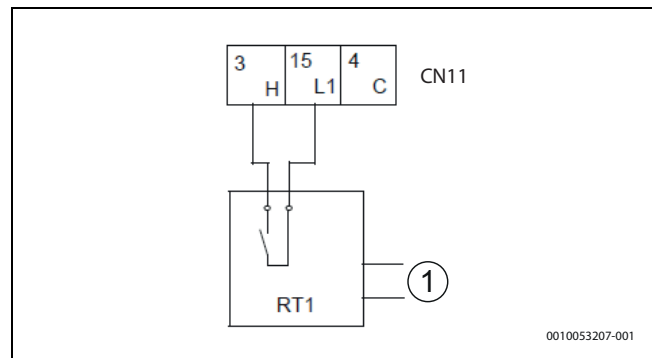

Fig. 101 Zone thermostat – Method B

[1] Power in



In the presence of a zone thermostat, the HMI must be used to control the water supply temperature. It is not possible to select air temperature control using the HMI air probe.

#### Method C

Double zone system with two zone thermostats managing ON/OFF, user interface managing the unit's mode change.

The hydraulic module is connected with two external temperature controllers:

- Zone 1 On-Off from input H - L1

- Zone 2 On-Off from input C - L1
- Heat-Cool from user interface

User interface setting:  
DUAL ROOM THERMOSTAT on YES.

HMI setting:  
ROOM THERMOSTAT = DOUBLE ZONE

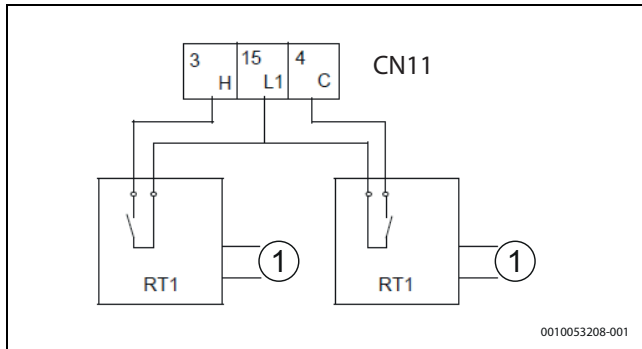

Fig. 102 Zone thermostat – Method C

[1] Power in



The electrical connection of the thermostat should match the user interface settings. For more information → Chapter 9, page 72. The power supply of the unit and that of the room thermostat must be connected to the same neutral line and to the phase line (L2) N (three-phase units only).

## 8.11 Units connected in cascade

### 8.11.1 Water connections

The water connection should preferably be an inverted return connection for better water balance between the different units.

- ▶ Install non-return valves in parallel units to stop the flow through the unit from short circuiting when the circulator is not running.

### 8.11.2 Electrical connections

- ▶ Use shielded wire in M/S cascade connections.



The shielding layer must be earthed.

To ensure successful auto-addressing:

- ▶ Connect all units to the same power supply and evenly power them.

The cascade function of the system supports a maximum of 6 units.

### 8.11.3 Backup master unit

It is possible to configure a unit as a backup master, preventing the interruption of certain functions should the master fail.

To configure a backup master:

- ▶ Set the dip-switch 3 of the S4 to **ON** At start-up.
- ▶ Configure the service parameters independently on both the HMI of the master and the backup master.
  - This can be done by setting the former and copying the parameters to the backup unit via USB.

This is the only way to ensure that when the master fails, the other will provide the system with the same pre-loaded functions. Switching from the Master to the Backup Master will only take place in the event of major system alarms and only the state (ON/OFF), Mode (Hot/Cold) and setpoint operation parameters are copied. The remaining user setting parameters are not transferred to the system in case of problems.

To prevent loss of the desired settings:

- ▶ Copy that set on the Master to the backup master on a regular basis.

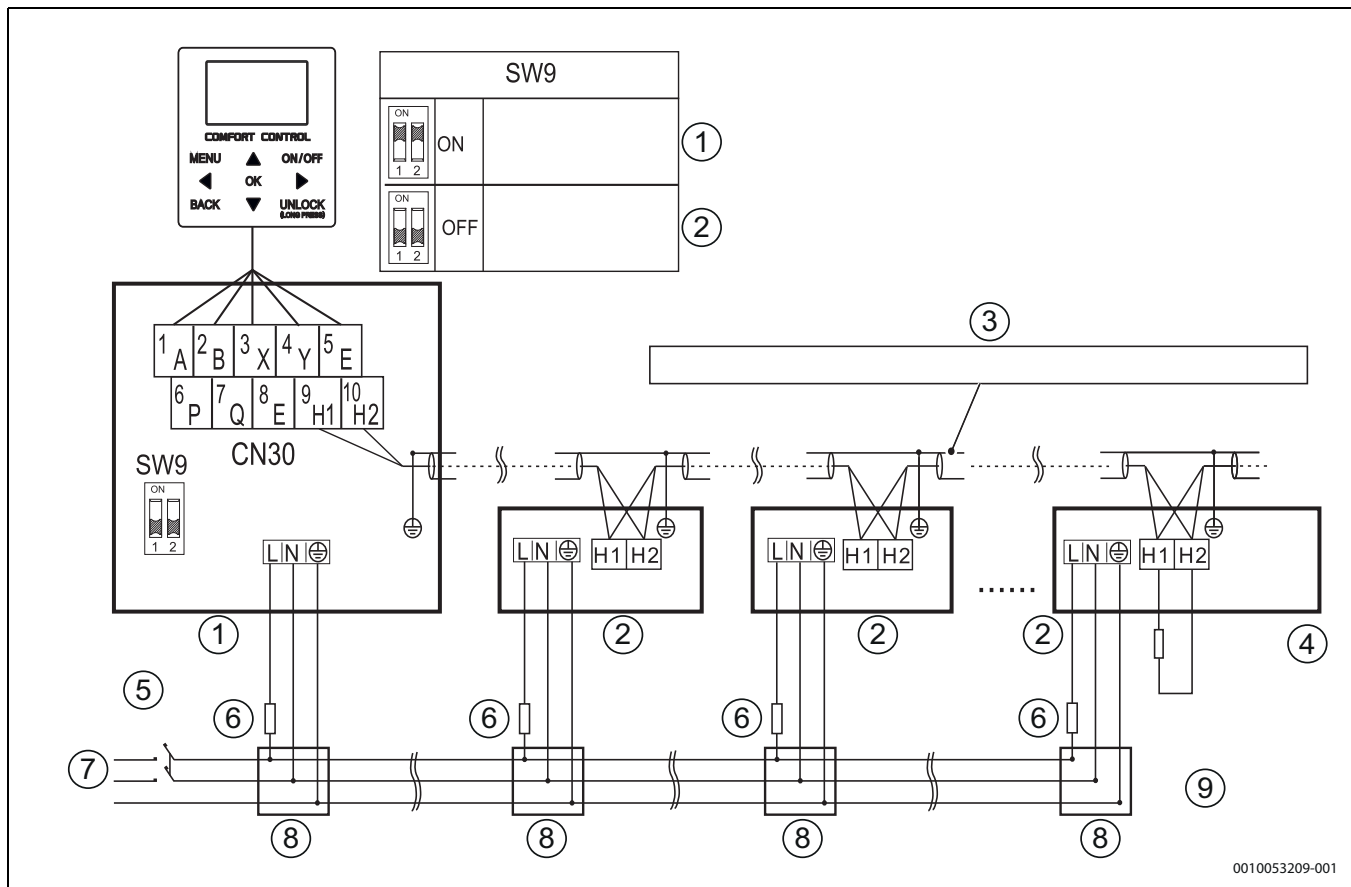

0010053209-001

Fig. 103 Wiring diagram of the electrical control system for the cascade system (1N ~)

- [1] Master unit
- [2] Slave unit
- [3] Please use shielded wire, and the shielding layer must be earthed.
- [4] Only the last IDU requires construction heater to be added to H1 and H2
- [5] On/Off switch
- [6] Fuse
- [7] Power supply
- [8] Distribution panel
- [9] External heater

#### 8.11.4 Configuration

Only one unit at any one time is configured as the system master.  
 On a M/S network, only one unit needs to be configured as master; configure SW9 as per Fig. 99, page 70:  
 Only the master unit can connect the master controller.

#### 9.1.1 Keypad

The HMI has a touch keypad with the following buttons:

## 9 Start-up - initial settings and functions

The unit is equipped with a user interface (hereafter also called HMI) to be installed on site and used to manage the functions. The user interface has a built-in temperature probe for possible use as a thermostat.

It is designed to have different levels of access depending on the settings to be adjusted:

- Free access functions are designed to be set by the Customer.
- Protected access functions are to be set by a specialised technician.



The unit must be configured to operate optimally before it can be put into regular service. Configuration entails a Technician adjusting the settings and parameters according to the type of system, climatic conditions, accessories installed and the Customer's usage preferences.

### 9.1 User interface

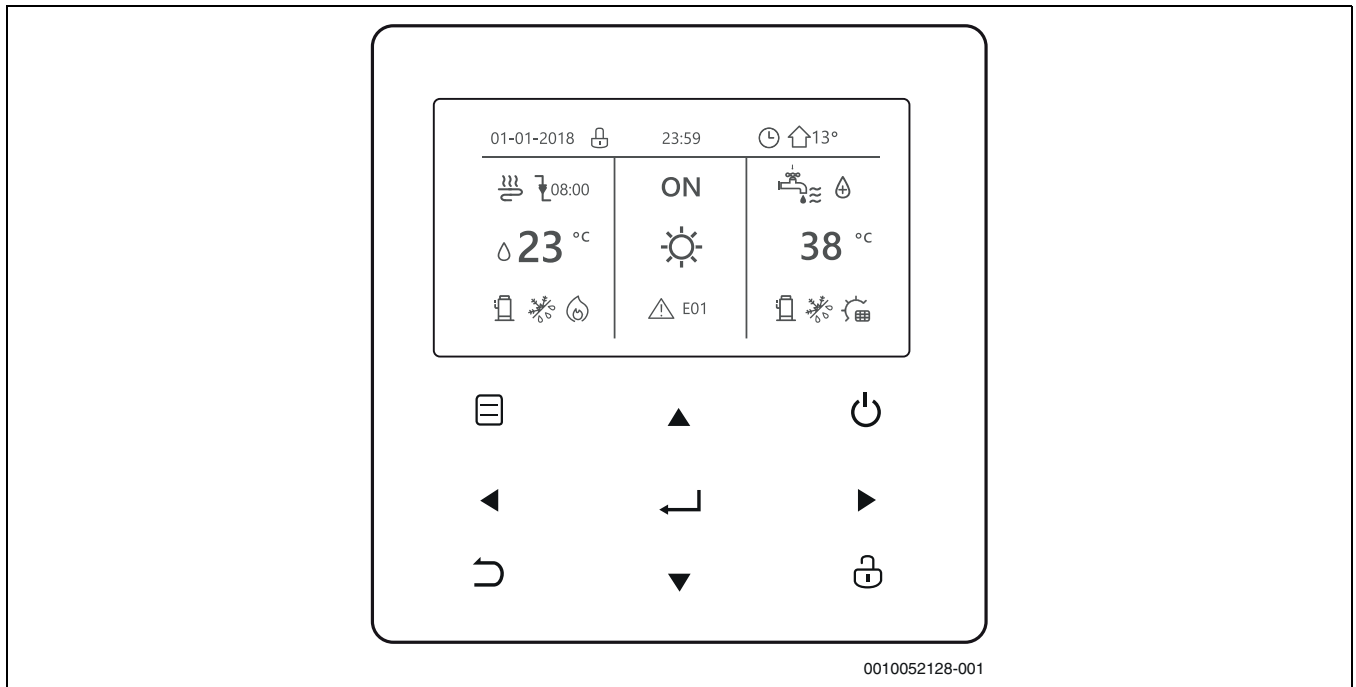

Fig. 104 Keypad







Buttons		Function
	MENU	To open the various menus from the HOME page
	ON/OFF	<ul style="list-style-type: none"> <li>To switch on/off the heating/cooling modes or DHW mode</li> <li>To switch on/off the functions in the menu structure</li> </ul>
	UNLOCK	<ul style="list-style-type: none"> <li>Press the button for 3 seconds to Unlock/Lock the keypad</li> </ul> To unlock/lock certain functions such as “DHW temperature control”
	OK	<ul style="list-style-type: none"> <li>To enter a submenu</li> <li>To confirm entered values</li> </ul>
	LEFT - RIGHT DOWN - UP	To move the cursor on the screen/navigate in the menu structure/adjust parameter settings
	BACK	To return to the previous level or page <ul style="list-style-type: none"> <li>Long button press to return straight to the home page</li> </ul>

Table 35 Keypad

### 9.1.2 Display and icons

The HMI display has the following icons:

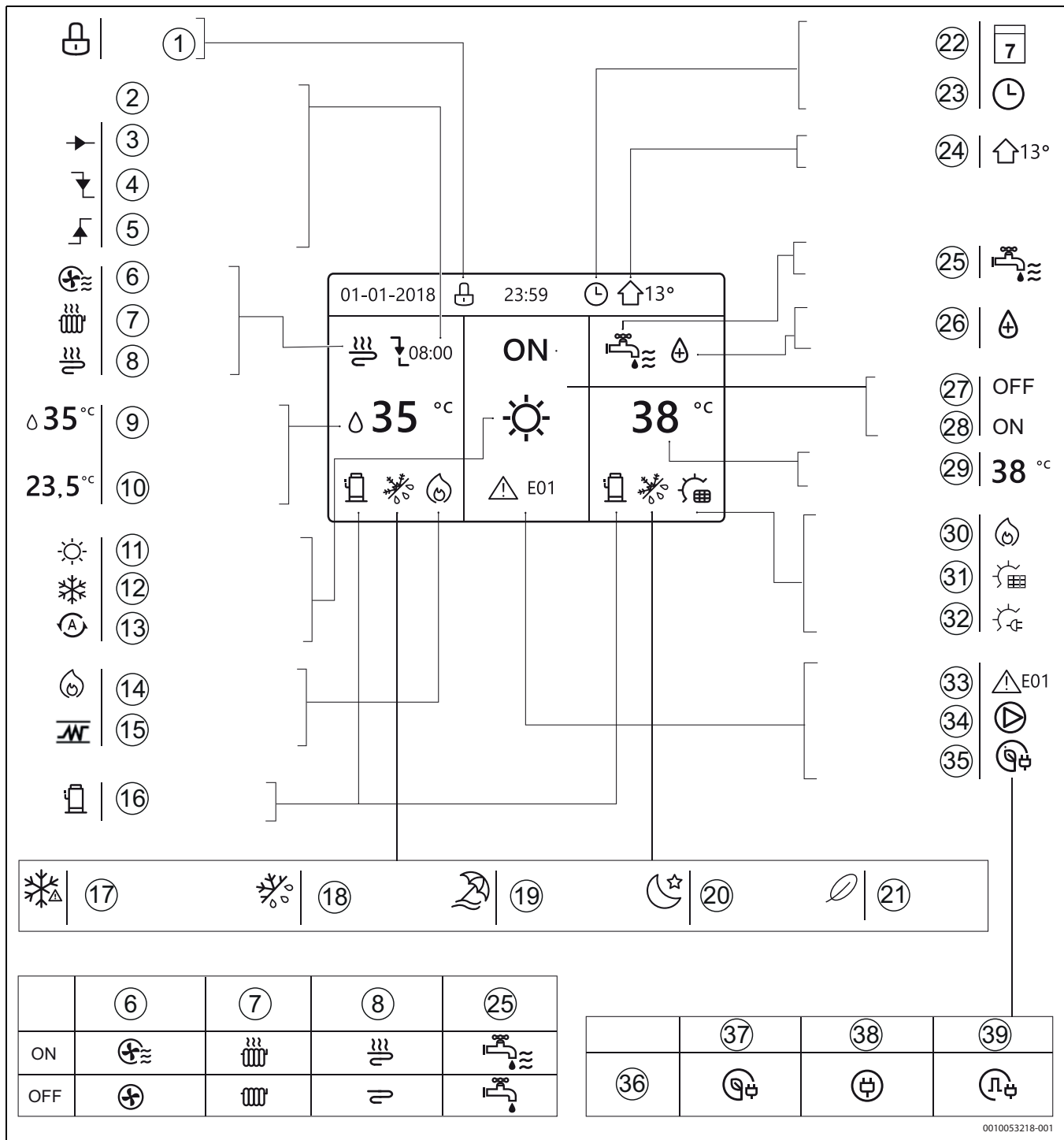

0010053218-001

Fig. 105 Display and icons

- [1] Keypad lock
- [2] At the next scheduled action, the temperature will decrease
- [3] The temperature does not change
- [4] The temperature decreases
- [5] The temperature increases
- [6] Fan coil
- [7] Radiator
- [8] Floor heating (radiant panels)
- [9] System water supply temperature (configurable)
- [10] Desired room temperature
- [11] Heating mode
- [12] Cooling mode
- [13] Automatic mode
- [14] Additional heat source
- [15] Electric heater
- [16] Compressor on
- [17] Antifreeze mode on
- [18] Defrosting mode on
- [19] Holiday away /at home on
- [20] Silent mode on
- [21] ECO mode on
- [22] Weekly schedule
- [23] Time schedule
- [24] Outdoor temperature
- [25] Domestic hot water (DHW)
- [26] Disinfect (anti-legionella) function on
- [27] Switch off
- [28] Switch on
- [29] DHW storage tank temperature
- [30] Additional heat source

- [31] Solar panel on
- [32] Storage tank electric heater on
- [33] Alarm
- [34] Pump on
- [35] Smart grid mode
- [36] Smart grid
- [37] Free
- [38] From the network
- [39] Peak



Temperature values are given in °C.

### 9.1.3 First switch-on and language selection

When the unit is switched on for the first time, the HMI will initialise the system and display the percentage of completion (1%~99%): the HMI cannot be used during this process.

The HMI then prompts you to select the system language from those available:

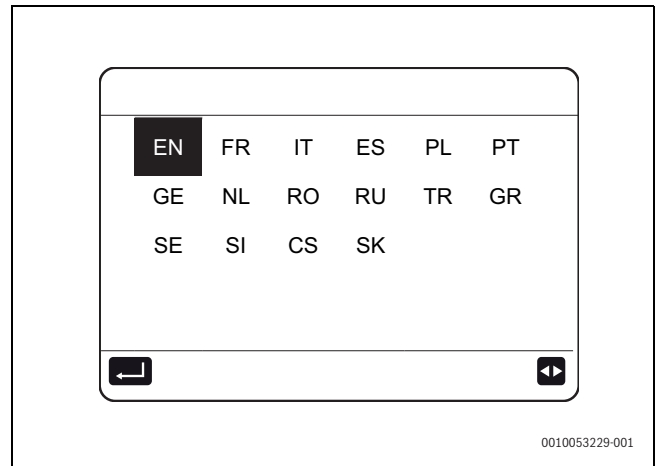



Fig. 106 Available languages

To select a language:

- ▶ Navigate through the options with .
- ▶ Confirm with .



If no language is confirmed within 60 seconds, the HMI will confirm the selected language when the time expires.

Once the selection has been made, the HMI will display the home page and it can be used normally.

### 9.1.4 Menu structure

The main menu is accessible from the home page by pressing  and contains the following sections:

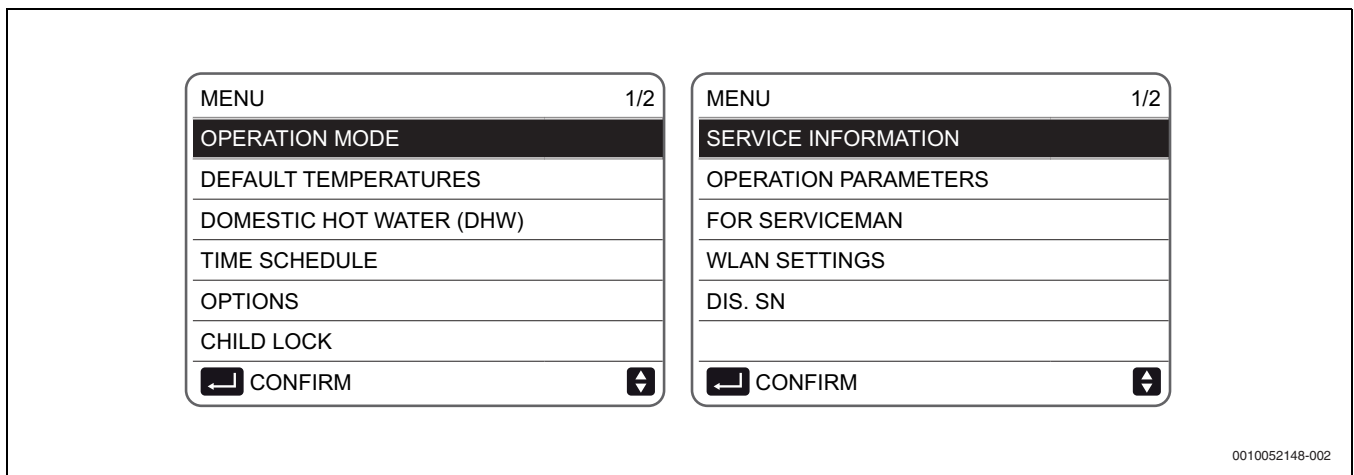



Fig. 107 Menu structure

Each of these categories allows specific unit functions and options to be set.

To select a category:

- ▶ Scroll through the sections with .
- ▶ Confirm with .



### 9.1.5 Functions reserved for the Technician

The **FOR SERVICEMAN** section contains the settings that can be adjusted by the Technician when starting the unit for the first time.

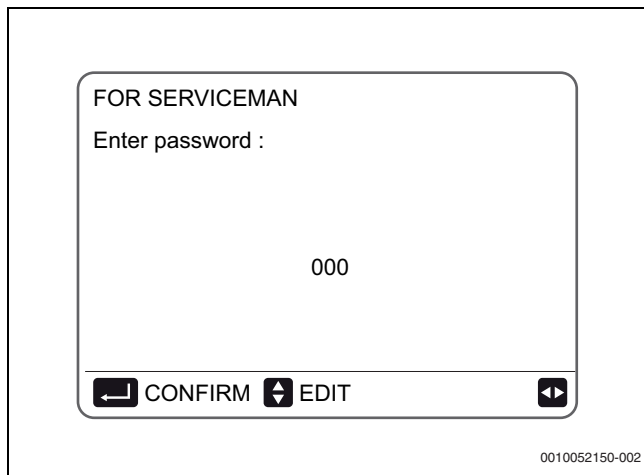
Once the appropriate section has been selected from the main menu, an access password will be requested:



The password to be entered is **234**:

- ▶ Choose the characters with .
- ▶ Edit the values with .

The **FOR SERVICEMAN** section is divided into the following sub-categories:

Fig. 108 Access password

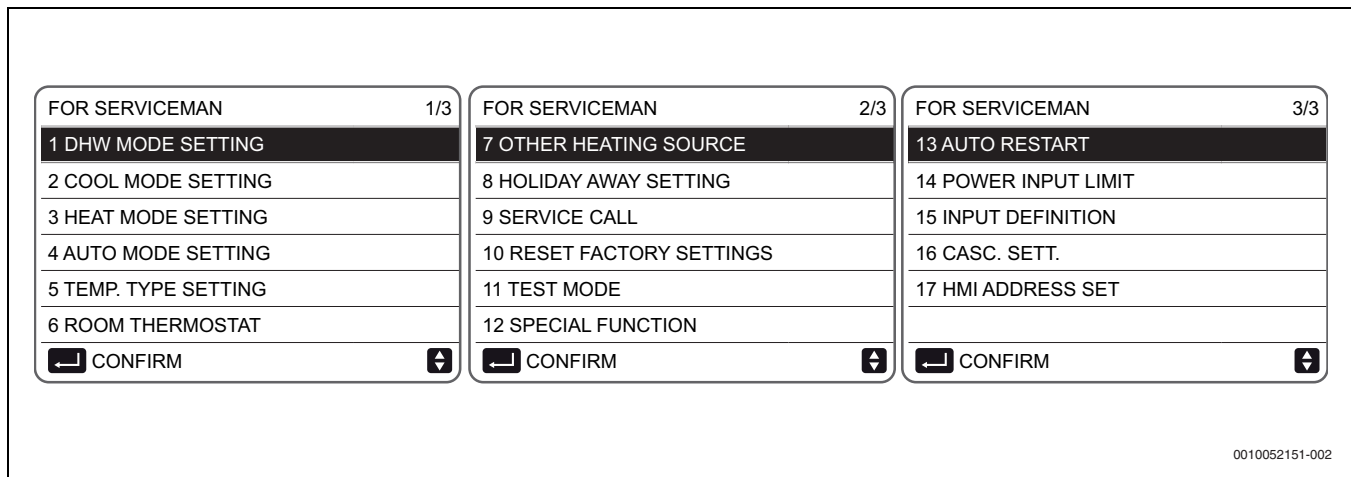



Fig. 109 FOR SERVICEMAN sub-categories

   
 → Chapter 9.2, page 77

When you have finished editing the desired parameters:

- ▶ Press .
- This page will appear:

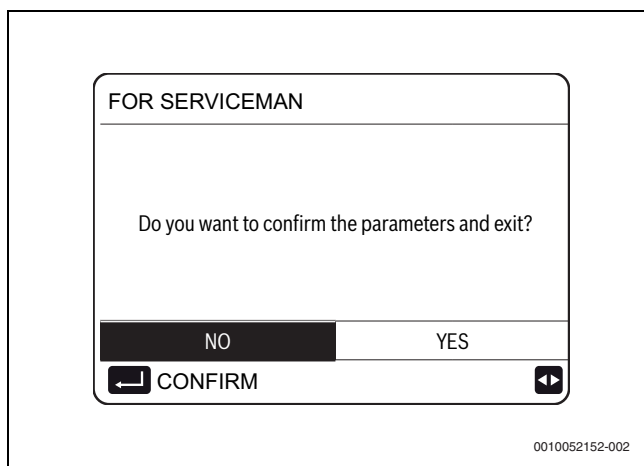



Fig. 110 Confirm the parameters

- ▶ Select **YES**.
- ▶ Confirm with  to save the settings and exit. After exiting, the unit will shut down.

### 9.1.6 Terminology used

The terms related to this unit are shown in the table below

Parameter	Description
AHS	Backup boiler
IBH	Backup electric heater
P_i	Unit pump or Zone 1 pump (for double zone systems)
P_o	Secondary circuit pump (or Zone 1 pump for double zone systems)
P_c	Zone 2 pump (for double zone systems)
P_d	DHW recirculation pump
P_s	Solar circuit pump
Pe	Evaporation pressure in Cooling mode or condensation pressure in Heating mode
SV1	3-way circuit/DHW diverter valve
SV2	3-way diverter valve for direct double zone systems
SV3	3-way mixing valve for mixed circuit
T1	Water supply temperature from additional heating source (with IBH heater or AHS boiler)
T2	Refrigerant temperature entering the user side exchanger (plate heat exchanger) in Cooling mode (or leaving in Heating mode)
T3	Refrigerant temperature leaving the source exchanger (coil) in Cooling mode (or entering in Heating mode)
T4	Outdoor air temperature
T5	DHW tank temperature
T1S	Water supply temperature setpoint
Ta	Room air temperature, detected by the probe in the HMI

Parameter	Description
Tbt1	Temperature of the upper part of the inertial storage tank
TBH	Backup electric heater for DHW (Domestic Hot Water) storage tank
Th	Compressor suction refrigerant temperature
Tp	Compressor discharge refrigerant temperature
Tsolar	Water temperature in the solar thermal circuit
Tw2	Water supply temperature for the mixed zone (for double zone systems)
TWin	Unit water return temperature
TWout	Unit water supply temperature

Table 36 Terminology used

## 9.2 Initial unit setting (requires a specialised Technician)

### 9.2.1 DHW (Domestic Hot Water) mode settings

#### ► MENU > FOR SERVICEMAN > 1. DHW MODE SETTING

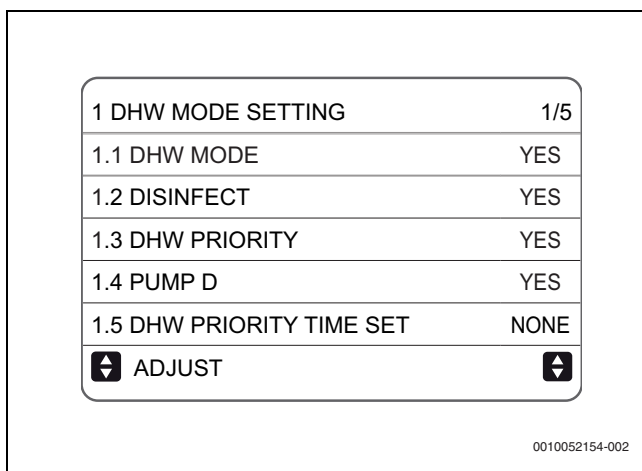

Fig. 111 1. DHW MODE SETTING: - Menu page 1/5

#### 1.1 DHW MODE (standard: YES - settable: YES/NO)

Enables/disables Domestic Hot Water mode

#### 1.2 DISINFECT (standard: YES - settable: YES/NO)

Enables/disables the anti-legionella cycle

#### 1.3 DHW PRIORITY (standard: YES - settable: YES/NO)

Defines whether DHW mode has priority over operation in Heating/Cooling mode

#### 1.4 PUMP\_D (standard: NO - settable: YES/NO)

Enables DHW recirculation management by the unit

#### 1.5 DHW PRIORITY TIME SET (standard: NO - settable: YES/NO)

Enables two controls and their respective parameters:

- In the presence of a DHW request, it defines a maximum operating time in Heating/Cooling mode before switching to DHW (managed with parameter  $t_{DHWHP\_RESTRICT}$ ).
- In the presence of a system request, it defines a maximum operating time in DHW before switching to Heating/Cooling mode (managed with parameter  $t_{DHWHP\_MAX}$ ).

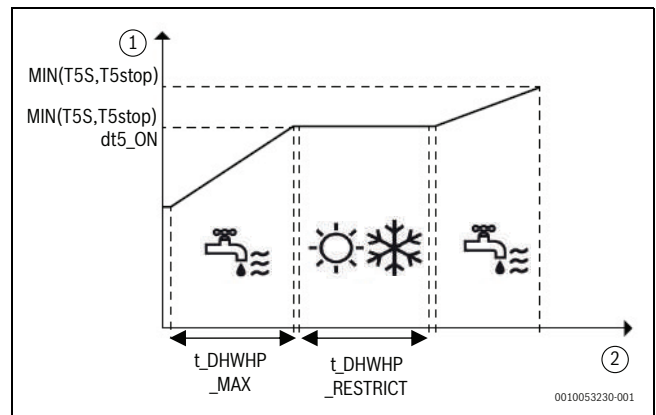

Fig. 112 1.5 DHW PRIORITY TIME SET

[1] Tank temperature

[2] Time

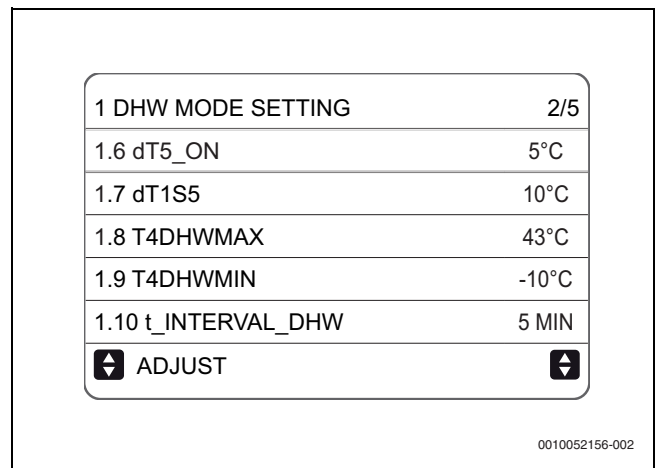

Fig. 113 1. DHW MODE SETTING: - Menu page 2/5

#### 1.6 dT5\_ON (standard: 10 - settable: 1/30)

Controls activation of the DHW request, defining the temperature range between DHW setpoint (T5S) and DHW storage tank temperature (T5) beyond which the heat pump is to be activated.

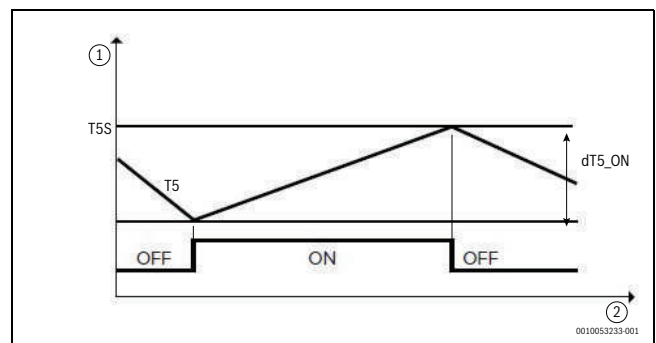

Fig. 114 1.6 dT5\_ON

[1] Tank temperature

[2] Time

DHW is requested when  $T5S - T5 \geq dT5\_ON$



A DHW request ends when  $T5 \geq T5S$  or when T5 reaches the maximum temperature for DHW in the heat pump  $T5_{stop}$ , which is parameterised according to the outdoor temperature  $T4$ .

Size	T4 [°C]						
	65 to 40	40 to 35	35 to 30	30 to 25	25 to 20	20 to 15	15 to 10
CS2000AWF 4 R-S to CS2000AWF 16 R-S/ CS2000AWF 16 R-T	45	48	50	55		56	57
CS2000AWF 18 R-T to CS2000AWF 30 R-T			48	50			
CS2000AWF 4 R-S to CS2000AWF 16 R-S/ CS2000AWF 16 R-T	56	55	52	50		40	35
CS2000AWF 18 R-T to CS2000AWF 30 R-T	55	53	50	48	45		

Table 37 Outdoor temperature T4



If there is a further demand for DHW beyond T5stop, the unit can activate the TBH boiler heater until setpoint T5S is reached.

**1.7 dT1S5 (standard: 10 - settable: 5/40)**

Defines the range between the water supply temperature (Twout) and the DHW storage tank temperature (T5). The heat pump in DHW mode will deliver water at Twout = T5 + dT1S5.



If the DHW setpoint (T5S) > 55 °C, change the parameter according to the formula dT1S5 = 65 - T5S. Setting dT1S5 higher than this criterium makes the unit work faster and less efficient in charging cycles but also means that the unit will go into normal protection before reaching the setpoint with subsequent restart and loss of the benefits of the faster ramp.

**1.8 T4DHWMAX (standard: 43 - settable: 35/43)**

Defines the maximum outdoor air temperature for which the unit can operate in DHW with heat pump.

**1.9 T4DHWMIN (standard: -10 - settable: -25/30)**

Defines the minimum outdoor air temperature for which the unit can operate in DHW with heat pump.



Below T4DHWMIN, if within the operating range, the unit can produce DHW with the DHW storage tank heater (TBH).

**1.10 t\_INTERVAL\_DHW (standard: 5 - not adjustable)**

Defines the minimum minutes between compressor shutdown and subsequent restart in DHW mode. Activation logic of heat pump and TBH storage tank heater in DHW mode.



The activation logics of the DHW storage tank heater (TBH) are automatically managed by the unit.

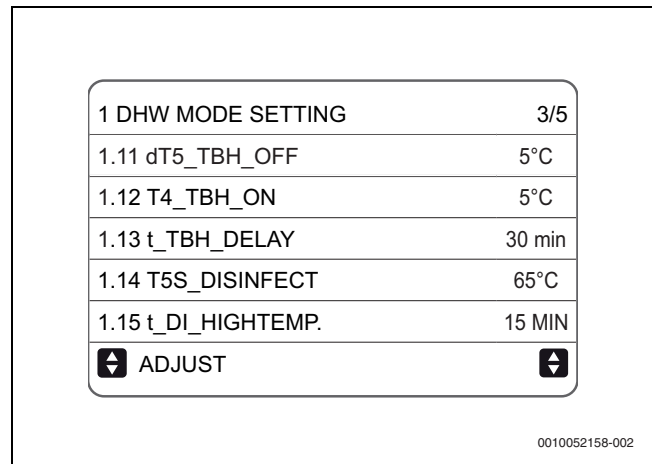

Fig. 115 1. DHW MODE SETTING: - Menu page 3/5

**1.11 dT5\_TBH\_OFF (standard: 5 - settable: 0/10)**

Defines how many degrees above the DHW setpoint (T5S) the storage tank heater (TBH) must be brought to. When TBH is activated, the DHW storage tank will be brought to temperature T5S + dT5\_TBH\_OFF.



When the temperature of the DHW storage tank (T5) reaches T5stop, the heat pump stops and the DHW storage tank heater (TBH) can continue to operate. The TBH heater is switched off when the DHW storage tank temperature is T5 > T5S + dT5\_TBH\_OFF or T5 > 65 °C. Any protection of the heating element built into the storage tank should be set to T5S+dT5\_TBH\_OFF.

**1.12 T4\_TBH\_ON (standard: 5 - settable: -5/50)**

Defines the maximum outdoor air temperature at which the TBH heater can be activated.

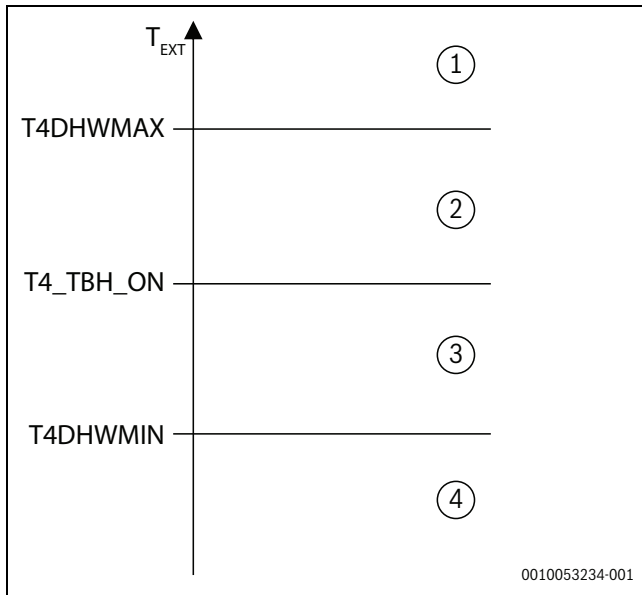

Fig. 116 TBH heater activation

- [1] Off
- [2] Heat pump only
- [3] Heat pump + heater
- [4] Heater only

**1.13 t\_TBH\_DELAY (standard: 30 - settable: 0/240)**

Defines the minimum minutes of compressor operation beyond which, if the unit fails to bring the DHW storage tank to the setpoint, the TBH heater can be activated.

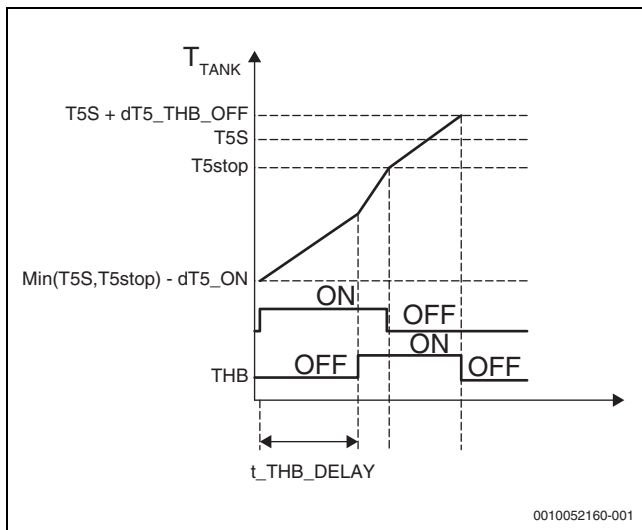

Fig. 117 Activation logic of the DISINFECT (anti-legionella) function

**1.14 T5S\_DISINFECT (standard: 65 - settable: 60/70)**

Defines the temperature to which the unit brings the DHW storage tank in the DISINFECT (anti-legionella) function.

**1.15 t\_DI\_HIGHTEMP (standard: 15 - settable: 5/60)**

Defines the minutes for which the unit should keep the DHW tank at temperature T5S\_DISINFECT in the DISINFECT (anti-legionella) function.

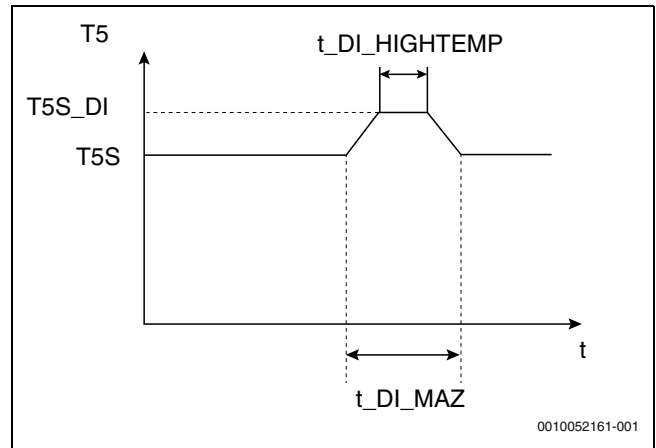

Fig. 118 1.15 t\_DI\_HIGHTEMP

T5 DHW storage tank water temperature  
T5S DHW set temperature

1 DHW MODE SETTING	4/5
1.16 t_DI_MAX	210 MIN
1.17 t_DHWHP_RESTRICT	30 MIN
1.18 t_DHWHP_MAX	120 MIN
1.19 PUMP_D TIMER	YES
1.20 PUMP_D RUNNING TIME	5 MIN
ADJUST	

Fig. 119 1. DHW MODE SETTING: - Menu page 4/5

**1.16 t\_DI\_MAX (standard: 210 - settable: 90/300)**

Defines the maximum minutes for which the unit can keep the DISINFECT (anti-legionella) function on.

**1.17 t\_DHWHP\_RESTRICT (standard: 30 - settable: 10/600)**

In the presence of a DHW request, it defines the maximum operating minutes of the heat pump in Heating/Cooling mode before switching to DHW mode. Clearly, the parameter only applies if priority has been given to the system.



During operation in Heating/Cooling mode, the heat pump switches to DHW mode once the system setpoint has been reached or after the minutes in t\_DHWHP\_RESTRICT have elapsed.

**1.18 t\_DHWHP\_MAX (standard: 90 - settable: 10/600)**

In the presence of a Heating/Cooling request, it defines the maximum operating minutes in DHW mode before switching to Heating/Cooling mode. Clearly, the parameter only applies if priority has been given to DHW.



During operation in DHW mode, the heat pump switches to Heating/Cooling mode once the DHW setpoint has been reached or after the minutes in t\_DHWHP\_MAX have elapsed.

**1.19 PUMP\_D TIMER (standard: YES - settable: NO/YES)**

Enables hourly scheduling of the DHW circulation pump. The pump schedule can be set by the user.



The recirculation pump requires a dedicated power supply.

**1.20 PUMP\_D RUNNING TIME (standard: 5 - settable: 5/120)**

Defines the operating minutes of the circulation pump when it is started.

1 DHW MODE SETTING	5/5
1.21 PUMP_D DISINFECT RUN	NONE
1.22 ACS FUNCTION	NONE
1.23 t_ANTILOCK	5 MIN
ADJUST	

0010052168-002

Fig. 120 1. DHW MODE SETTING - Menu page 5/5

**1.21 PUMP\_D DISINFECT RUN (standard: YES - settable: NO/YES)**

Enables activation of the recirculation pump even during the anti-legionella cycle. Activation of the function is recommended. It becomes mandatory if T5 is located below the additional heater (TBH).

**1.22 ACS FUNCTION (standard: NO - settable: YES/NO)**

Reserved parameter, do not change.

**1.23 t\_ANTILOCK (standard: 5 - settable: 0/60)**

Enables a safety opening cycle of all system valves (SV1, SV2, SV3), defining their opening minutes if they remain closed for more than 24 hours.

**9.2.2 Cooling mode settings**

► MENU > FOR SERVICEMAN > 2.COOL MODE SETTING

**2.1 COOL MODE (standard: YES - settable: YES/NO)**

Enables/disables Cooling mode.

**2.2 t\_T4\_FRESH\_C (standard: 0.5 - settable: 0.5/6)**

Sets the time when the unit updates the climate curve, adjusting it according to the outdoor air temperature.

**2.3 T4CMAX (standard: 52 - settable: 35/52)**

Defines the maximum outdoor air temperature for which the unit can operate in Cooling mode. This value should clearly be changed if the unit is used for process cooling.

**2.4 T4CMIN (standard: 10 - settable: -5/25)**

Defines the minimum outdoor air temperature for which the unit can operate in Cooling mode. This value should clearly be changed if the unit is used for process cooling.

**2.5 dT1SC (standard: 5 - settable: 2/10)**

Defines the range between the water supply temperature (T1) and the setpoint (T1S) within which the unit starts to operate in Cooling mode. The heat pump starts when  $T1 \geq T1S + dT1SC$  and stops when  $T1 \leq T1S$ .

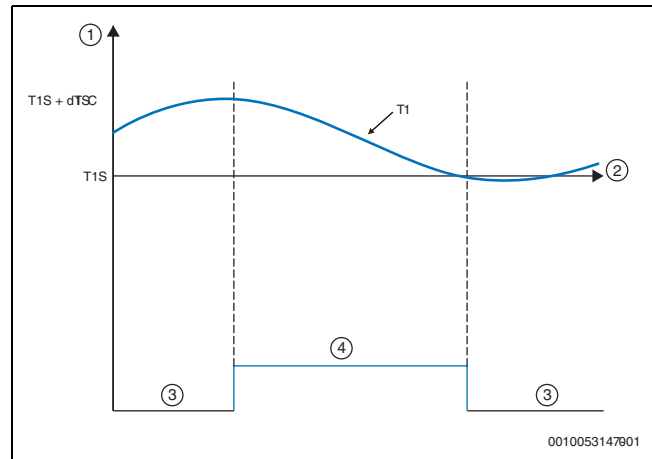

Fig. 121 Cooling mode - Water supply temperature (T1)

- [1]  $T_{Water}$
- [2] Time
- [3] Stand-by
- [4] On

This value is strongly related to the minimum permissible water content of the circuit. A narrower control band can be accepted with a high water volume.

**2.6 dTSC (standard: 2 - settable: 1/10)**

Defines the range between the room air temperature ( $T_a$ ) and the setpoint ( $T_S$ ) within which the unit starts to operate in Cooling mode. The heat pump starts when  $T_a \geq T_S + dTSC$  and stops when  $T_a \leq T_S$ .

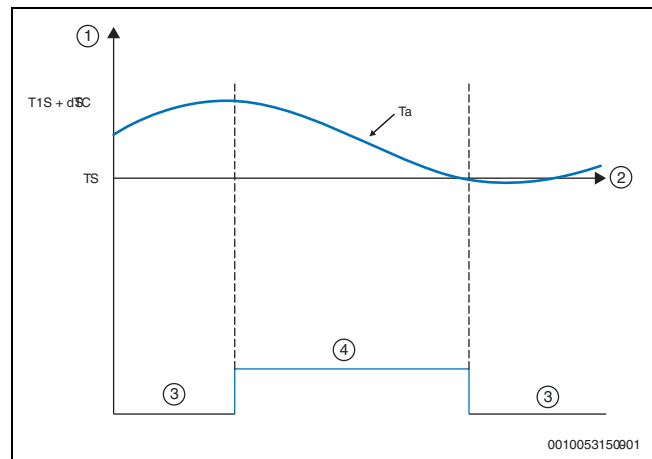

Fig. 122 Cooling mode - Air temperature ( $T_a$ )

- [1]  $T_{Room}$
- [2] Time
- [3] Stand-by
- [4] On



The parameter is only used if the unit's Cooling mode control is on room air temperature.

**2.7 t\_INTERVAL\_C (standard: 5 - not adjustable)**

Defines the minimum minutes between compressor shutdown and subsequent restart in Cooling mode. Among the climate curves that can be set for Cooling mode, a customisable one can be set with logic as shown in the graph.

**2.8 T1SetC1 (standard: 10 - settable: 5/25)**

Sets the maximum water supply setpoint for the customisable climate curve in Cooling mode.

**2.9 T1SetC2 (standard: 16 - settable: 5/25)**

Sets the minimum water supply setpoint for the customisable climate curve in Cooling mode.

**2.10 T4C1 (standard: 35 - settable: -5/46)**

Sets the minimum outdoor air temperature at which the setpoint T1SetC1 is activated for the customisable climate curve in Cooling mode.

**2.11 T4C2 (standard: 25 - settable: -5/46)**

Sets the maximum outdoor air temperature at which the setpoint T1SetC2 is activated for the customisable climate curve in Cooling mode.

**2.12 ZONE1 C-EMISSION (standard: CRP (CS2000AWF 4 R-S-CS2000AWF 16 R-S/CS2000AWF 16 R-T) / CVC (CS2000AWF 18 R-T-CS2000AWF 30 R-T) - settable: CRP/CVC/RAD)**

Sets the type of distribution system in Cooling mode of the system's zone 1.



CRP = radiant / CVC = fan coils / RAD = radiators.

**2.13 ZONE2 C-EMISSION (standard: CRP (CS2000AWF 4 R-S-CS2000AWF 16 R-S/CS2000AWF 16 R-T) / CVC (CS2000AWF 18 R-T-CS2000AWF 30 R-T) - settable: CRP/CVC/RAD)**

Sets the type of distribution system in Cooling mode of the system's zone 2.



CRP = radiant / CVC = fan coils / RAD = radiators.

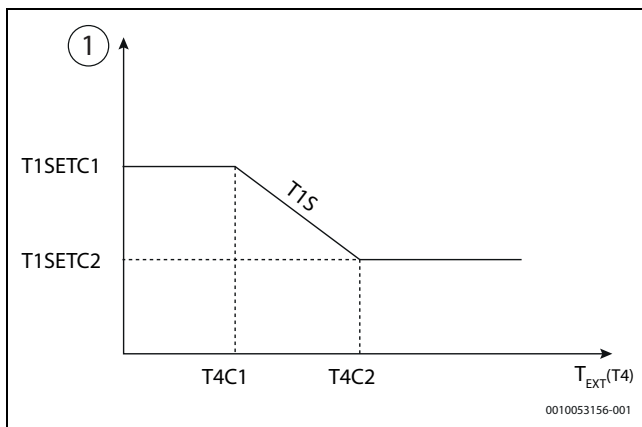

Fig. 123 Cooling mode - Setting of distribution system

[1] T<sub>Water supply</sub> (T1S)

**9.2.3 Heating mode settings**

► MENU > FOR SERVICEMAN > 3. HEAT MODE SETTING

**3.1 HEAT MODE (standard: YES - settable: YES/NO)**

Enables/disables Heating mode.

**3.2 t<sub>T4\_FRESH\_H</sub> (standard: 0.5 - settable: 0.5/6)**

Sets the time when the unit updates the climate curve, adjusting it according to the outdoor air temperature.

**3.3 T4HMAX (standard: 25 - settable: 20/35)**

Defines the maximum outdoor air temperature for which the unit can operate in Heating mode.

**3.4 T4HMIN (standard: -15 - settable: -25/30)**

Defines the minimum outdoor air temperature for which the unit can operate in Heating mode.

**3.5 dT1SH (standard: 5 - settable: 2/10)**

Defines the range between the water supply temperature (T1) and the setpoint (T1S) within which the unit starts to operate in Heating mode. The heat pump starts when  $T1 \leq T1S - dT1SH$  and stops when  $T1 \geq T1S$ .

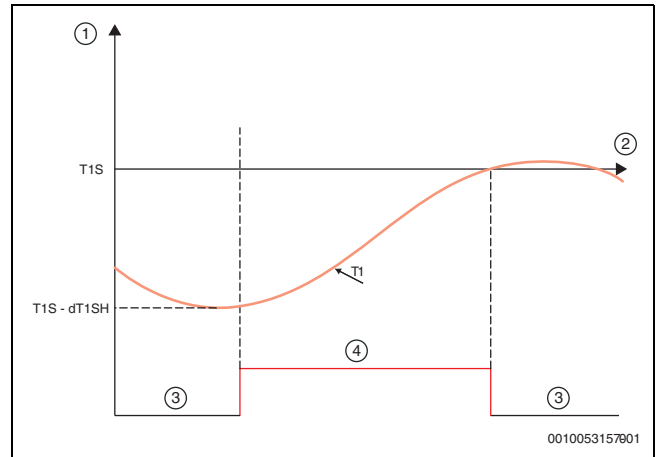

Fig. 124 Heating mode - Water supply temperature (T1)

[1] T<sub>Water</sub>  
[2] Time  
[3] Stand-by  
[4] On

This value is strongly related to the minimum permissible water content of the circuit. A narrower control band can be accepted with a high water volume.

**3.6 dTSH (standard: 2 - settable: 1/10)**

Defines the range between the room air temperature (Ta) and the setpoint (TS) within which the unit continues to operate in Heating mode. The heat pump starts when  $Ta \leq TS - dTSH$  and stops when  $Ta \geq TS$ .

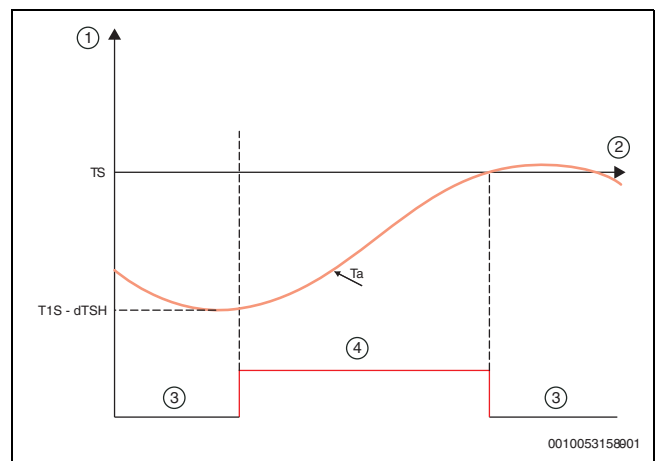

Fig. 125 Heating mode - Air temperature (Ta)

[1] T<sub>Room</sub>  
[2] Time  
[3] Stand-by  
[4] On



The parameter is only used if the unit's Heating mode control is on room air temperature.

**3.7 t<sub>INTERVAL\_H</sub> (standard: 5 - not adjustable)**

Defines the minimum minutes between compressor shutdown and subsequent restart in Heating mode.

Among the climate curves that can be set for Heating mode, a customisable one can be set with logic as shown in the graph.

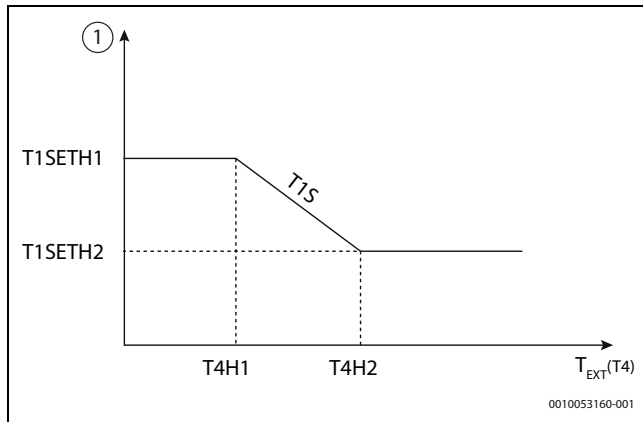

Fig. 126 Heating mode - Interval

[1]  $T_{\text{water supply}} (T1S)$

**3.8 T1SetH1 (standard: 35 - settable: 25/60 (CS2000AWF 18 R-T-CS2000AWF 30 R-T) / 65 (CS2000AWF 4 R-S-CS2000AWF 16 R-S/CS2000AWF 22 R-T))**

Sets the maximum water supply setpoint for the customisable climate curve in Heating mode.

**3.9 T1SetH2 (standard: 28 - settable: 25/60 (CS2000AWF 18 R-T-CS2000AWF 30 R-T) / 65 (CS2000AWF 4 R-S-CS2000AWF 16 R-S/CS2000AWF 22 R-T))**

Sets the minimum water supply setpoint for the customisable climate curve in Heating mode.

**3.10 T4H1 (standard: -5 - settable: -25/35)**

Sets the minimum outdoor air temperature at which the setpoint T1SetH1 is activated for the customisable climate curve in Heating mode.

**3.11 T4H2 (standard: 7 - settable: -25/35)**

Sets the maximum outdoor air temperature at which the setpoint T1SetH2 is activated for the customisable climate curve in Heating mode.

**3.12 ZONE1 H-EMISSION (standard: RAD (CS2000AWF 4 R-S-CS2000AWF 16 R-S/CS2000AWF 16 R-T) / RAD (CS2000AWF 18 R-T-CS2000AWF 30 R-T) - settable: CRP/CVC/RAD)**

Sets the type of distribution system in Heating mode of the system's zone 1.



CRP = radiant / CVC = fan coils / RAD = radiators.

**3.13 ZONE2 H-EMISSION (standard: CRP (CS2000AWF 4 R-S-CS2000AWF 16 R-S/CS2000AWF 16 R-T) / CRP (CS2000AWF 18 R-T-CS2000AWF 30 R-T) - settable: CRP/CVC/RAD)**

Sets the type of distribution system in Heating mode of the system's zone 2.



CRP = radiant / CVC = fan coils / RAD = radiators.

**3.14 t\_DELAY\_PUMP (standard: 2 - settable: 0.5/20)**

Sets the minutes of delay between compressor switch-off and pump switch-off.

#### 9.2.4 Automatic mode settings

► MENU > FOR SERVICEMAN > 4.AUTO MODE SETTING

**4.1 T4AUTOCMIN (standard: 25 - settable: 20/29)**

Defines the minimum outdoor temperature below which the heat pump will not work in Cooling mode in automatic mode.

**4.2 T4AUTOHMAX (standard: 17 - settable: 10/17)**

Defines the maximum outdoor temperature beyond which the heat pump will not work in Heating mode in automatic mode.

In combination with a possible additional electric heater and the previously set parameters, AUTO mode operation follows this pattern:

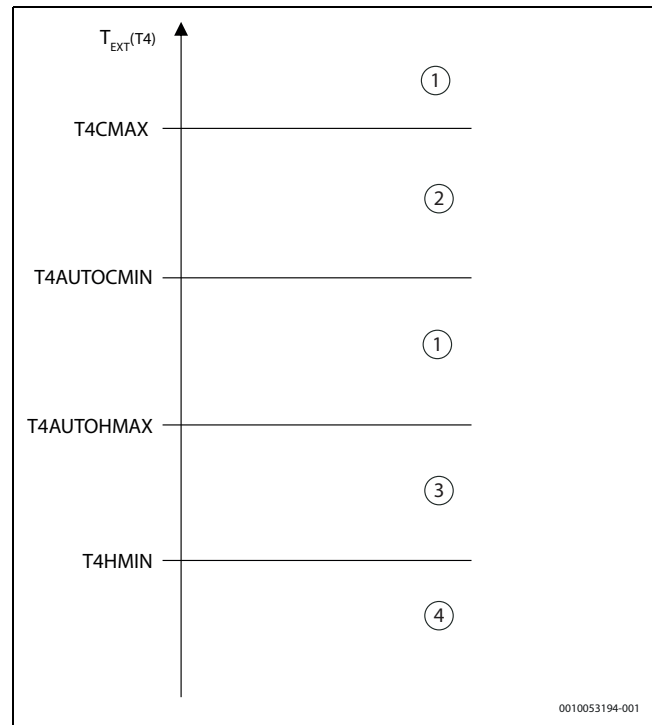

Fig. 127 AUTO mode operation

[1] Stand-by

[2] Cooling

[3] Heating

[4] Stand-by (possible additional source T4\_IBH\_ON)

#### 9.2.5 Control settings

During the initial start-up phase, the type of control required for the system can be selected.

The unit can be managed with control on:

- supply water temperature (T1), which has two options:
  - fixed setpoint, set from the user interface
  - auto control setpoint, calculated from a preselected climate curve
- room temperature ( $T_a$ )

► MENU > FOR SERVICEMAN > 5.TEMP. TYPE SETTING

The request to the unit can be made from the user interface (thanks to the built-in temperature sensor) or from the electromechanical thermostat. In the second case, the zone thermostat can only control the Heating/Cooling mode change if it has a double relay, otherwise it must be managed by HMI.

**5.1 WATER FLOW TEMP. (standard: YES - settable: YES/NO)**

Enables/disables control of the unit according to the supply water temperature (T1). The user can set the system water temperature (T1S) from the HMI.

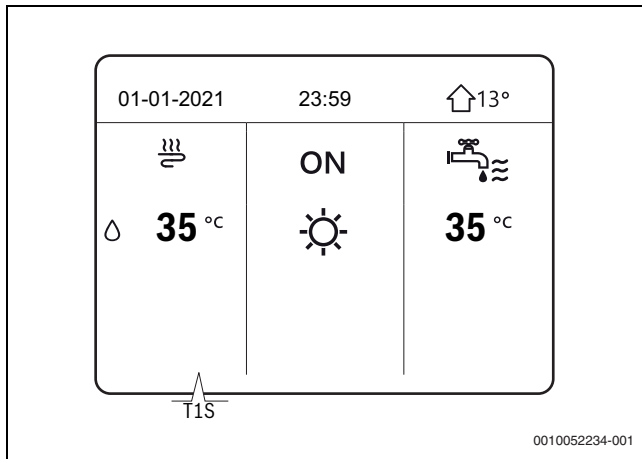

Fig. 128 System water temperature (T1S)

**5.2 ROOM TEMP. (standard: NO - settable: YES/NO)**

Enables/disables control of the unit according to the room air temperature (Ta). The user can set the desired temperature in the room (TS) from the HMI.

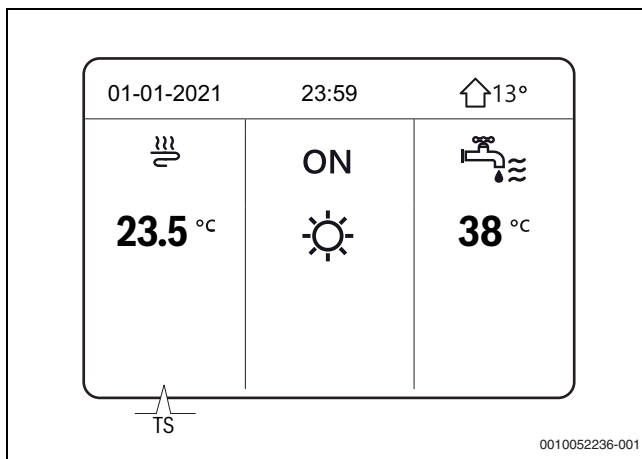

Fig. 129 Room air temperature (Ta)



The supply water temperature is automatically controlled according to the climate curve.

**5.3 DOUBLE ZONE (standard: NO - settable: YES/NO)**

Enables/disables management of a second system zone: a second menu dedicated to management of Zone 2 appears on the HMI display.



Parameters 5.1 and 5.2 are set to **YES**, 5.3 will be automatically changed to **YES**.

The two zones can be controlled in different ways:

• **Zone 1 and Zone 2**

Both are controlled according to the supply water temperature (T1).

- ▶ Set parameter **5.1 WATER FLOW TEMP.** to **YES**.
- ▶ Set parameter **5.2 ROOM TEMP.** to **NO**.

Zone 1 will have setpoint T1S and Zone 2 will have setpoint T1S2 and the HMI will display these pages:

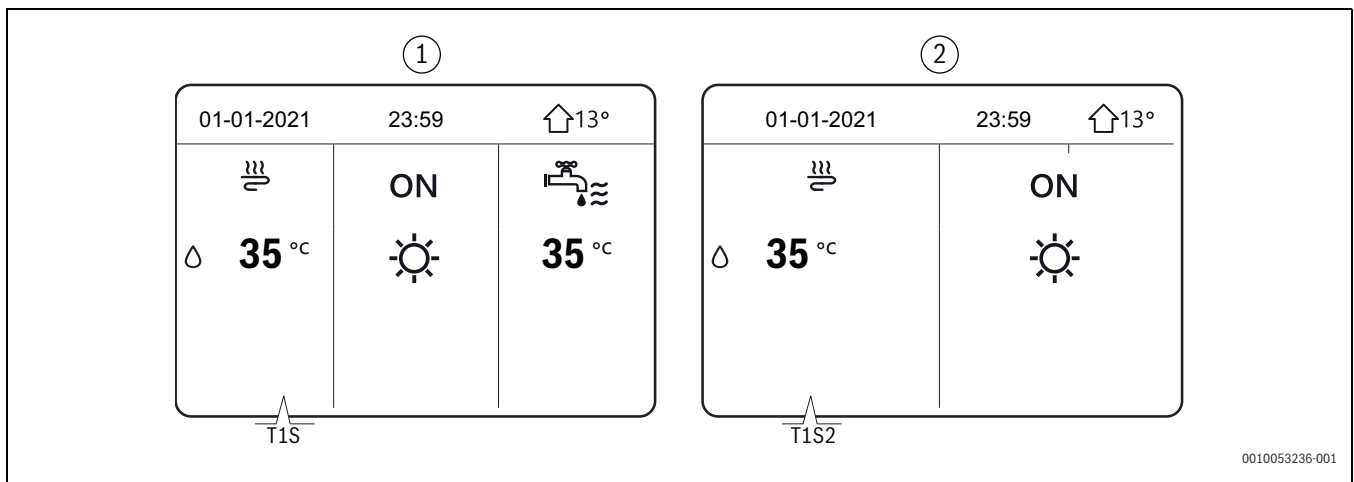

Fig. 130 Zone 1 and Zone 2: Setpoints

- [1] Home page zone 1
- [2] Home page zone 2

• **Zone 1**

With control based on the supply water temperature (T1) and Zone 2 with control based on the room air temperature (Ta):

- ▶ Set parameter **5.1 WATER FLOW TEMP.** to **YES**.
- ▶ Set parameter **5.2 ROOM TEMP.** to **YES**.

Zone 1 will have setpoint T1S and Zone 2 will have setpoint T1S2 and the HMI will display these pages:

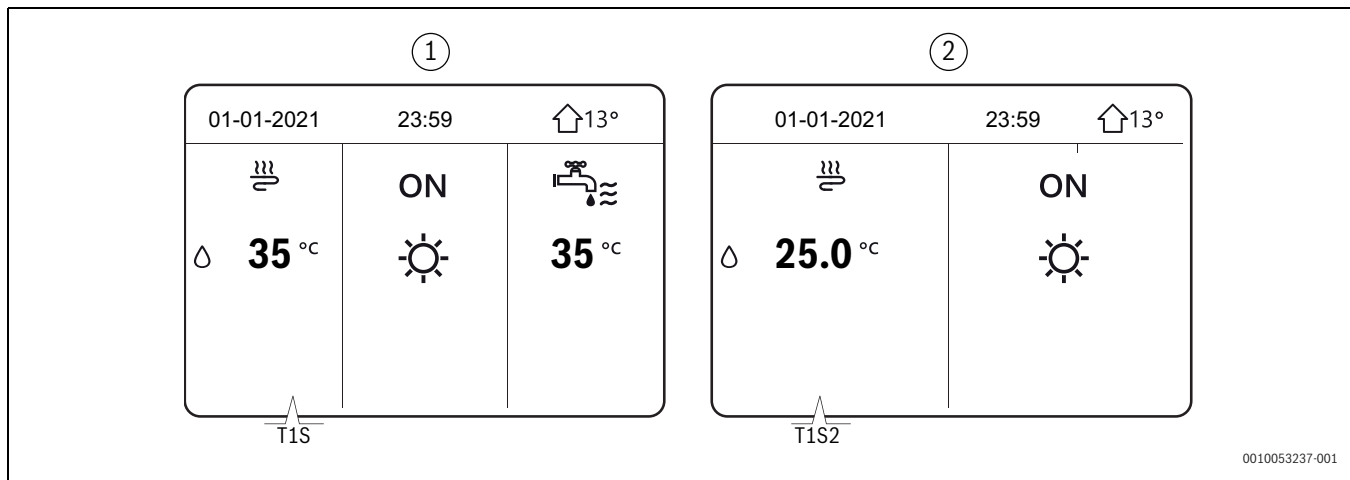

Fig. 131 Zone 1: Setpoints

- [1] Home page zone 1  
[2] Home page zone 2



Zone 2 has automatically controlled supply water temperature according to the climate curve. In double zone systems, Zone 1 cannot have room air temperature control.



Both zones can be equipped with an electromechanical thermostat to manage the request.

### 9.2.6 Zone thermostat settings

#### ► MENU > FOR SERVICEMAN > 6.ROOM THERMOSTAT

A zone thermostat can be used to manage the request to the unit.



The HMI must still be connected to the unit in order to manage its internal parameters.

### 6.1 ROOM THERMOSTAT (standard: NO - settable: NO/MODE SET / ONE ZONE/DOUBLE ZONE)

Enables/disables the request to the unit from zone thermostats other than the HMI.

NO = no zone thermostat.

MODE SET = single zone system with double relay zone thermostat, for managing the request to the unit and seasonal mode change (type A connection → Chapter 8.10, page 70)

ONE ZONE = single zone system with zone thermostat, for managing the request to the unit (type B connection → Chapter 8.10, page 70). The seasonal mode change can be managed by the HMI.

DOUBLE ZONE = double zone system, each with zone thermostat, for managing the request to the unit (type C connection → Chapter 8.10, page 70). The seasonal mode change of both zones can be managed by the HMI.

### 9.2.7 Additional heating source settings

#### ► MENU > FOR SERVICEMAN > 7.OTHER HEATING SOURCE

This section is used to adjust the parameters of an additional/backup electric heater on the system (IBH), a boiler (AHS) or a solar thermal system.



These sources are optional and can be supplied separately. Only one additional Heating source, either electric heater or boiler, can be managed at the same time.

The connection and control of an electric heater in a system or boiler requires a dedicated water temperature probe, to be fitted on the downstream water supply line:

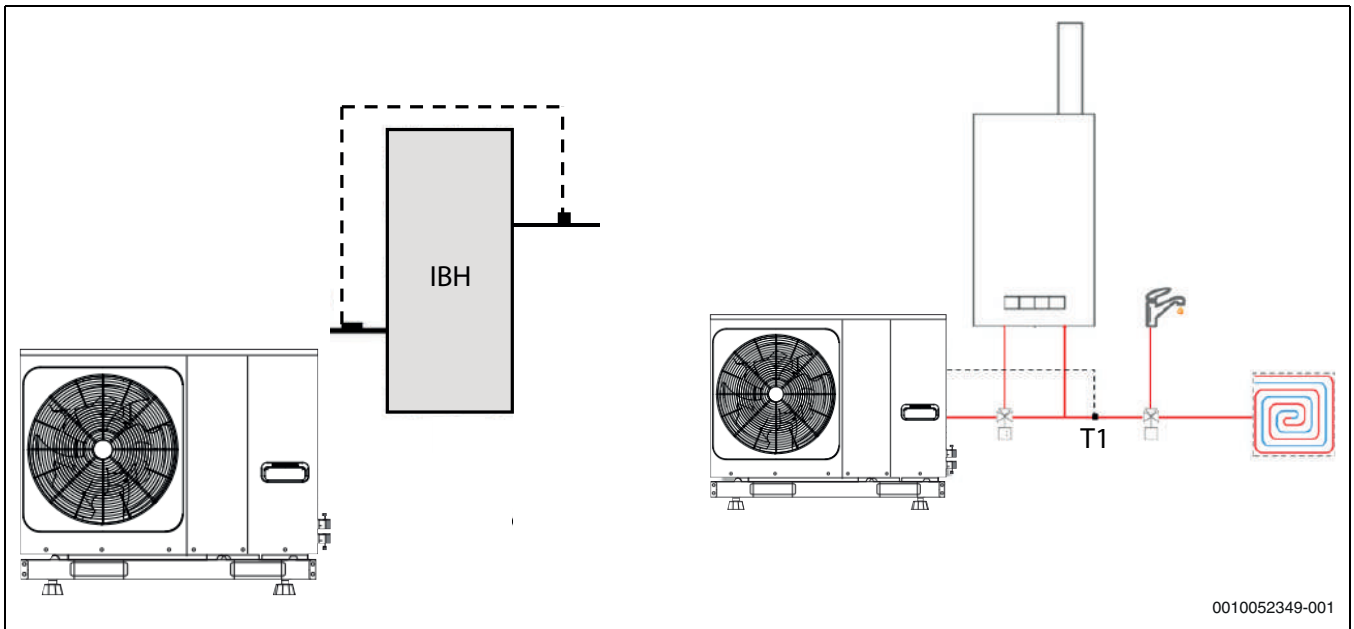

Fig. 132 Additional heating source settings

During installation:

- ▶ Activation operating mode (in Heating, DHW production or both) must be selected with the dip-switches on the board.
- **Very low outdoor temperature:** parameter T4\_IBH\_ON or T4\_AHS\_ON: the minimum outdoor air temperature for heat pump operation only

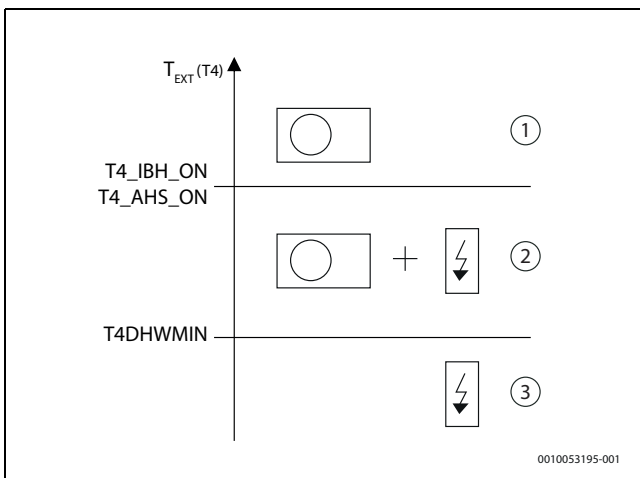

Fig. 133 Very low outdoor temperature

- [1] Heat Pump only
- [2] Heat Pump and Heater
- [3] Heater only



To make the additional source work only as a replacement for the unit:

- ▶ Set the parameter to the same value as T4HMIN (the minimum outdoor temperature at which the heat pump can operate).
- **Supply temperature too far from the setpoint:** parameter dt1\_IBH\_ON or dt1\_AHS\_ON: the minimum  $\Delta T$  between water setpoint TS1 and unit supply T1
- **Too long to reach the setpoint:** parameter t\_IBH\_DELAY or t\_AHS\_DELAY: the maximum waiting time between compressor start-up and additional source start-up

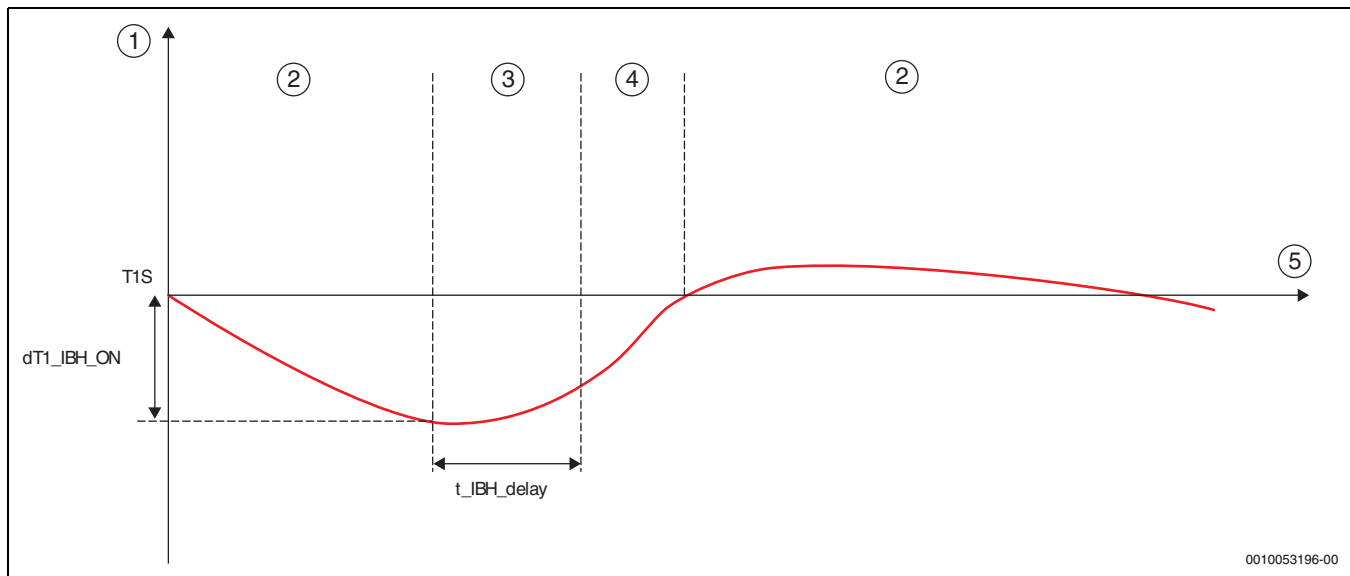

Fig. 134 Supply temperature too far from the setpoint/too long to reach the setpoint

- [1]  $T_{\text{Water}} (T1)$
- [2] Stand-by
- [3] Heat Pump only
- [4] Heat Pump and source
- [5] Time



The BACKUP HEATER function allows start-up of the additional source to be forced from the HMI (→ Chapter 9.2, page 77).

#### 7.1 dT1\_IBH\_ON (standard: 5 - settable: 2/10)

Defines the range between the water supply temperature (T1) and the setpoint (T1S) beyond which the heater is switched on. When  $T1 \leq T1S - dT1S\_IBH\_O$  the heater is switched on.

#### 7.2 t\_IBH\_DELAY (standard: 30 - settable: 15/120)

Defines the minimum minutes between compressor start-up and heater start-up.

#### 7.3 T4\_IBH\_ON (standard: -5 - settable: -15/30)

Defines the outdoor temperature below which the heater can be used. If the outdoor temperature is higher than T4\_IBH\_ON, the heater cannot be used.

#### 7.4 dT1\_AHS\_ON (standard: 5 - settable: 2/20)

Defines the range between the water supply temperature (T1) and the setpoint (T1S) beyond which the boiler is switched on. When  $T1S - T1 \geq dT1S\_AHS\_O$ , the boiler is switched on.

#### 7.5 t\_AHS\_DELAY (standard: 30 - settable: 5/120)

Defines the minimum minutes between compressor start-up and boiler start-up.

#### 7.6 T4\_AHS\_ON (standard: -5 - settable: -15/30)

Defines the outdoor temperature below which the boiler can be used. If the outdoor temperature is higher than T4\_AHS\_ON, the heater cannot be used.

#### 7.7 IBH LOCATE (standard: 0 - settable: 0/1)

Reserved for factory settings.

#### 7.8 P\_IBH1 (standard: 0 - settable: 0/20)

Defines the electric power of the heater, if present: the value set here is used to calculate the heat output and efficiency of the unit. IBH1 must be set to the power of the first stage. The parameters do not count the power of external elements because the power port is different.

#### 7.9 P\_IBH2 (standard: 0 - settable: 0/20)

Reserved for factory settings.

#### 7.10 P\_TBH (standard: 2 - settable: 0/20)

Defines the electric power of the DHW tank heater, if present: the value set here is used to calculate the heat output and efficiency of the unit.

#### 7.11 EnSwitchPDC (standard: YES - settable: YES/NO)

Enables/disables the intelligent function for hybrid € switch heat pumps. The € switch function analyses the operating conditions of the unit and uses an algorithm to calculate the minimum efficiency that the heat pump must have in order to continue to operate more economically than the boiler. Should the heat pump operate below this efficiency, the unit switches off the heat pump and only uses the boiler. The € switch function uses the cost of fuel gas (€/Smc from a bill, to be entered in parameter GAS\_COST) and the cost of electricity (€/kWh from a bill, to be entered in parameter ELE\_COST).



The logics that activate the boiler to supplement the capacity of the heat pump remain unchanged even with the € switch function on.

#### 7.12 GAS-COST (standard: 0.85 - settable: 0/5)

Defines the cost of fuel gas used to power the boiler (in €/Smc, from a bill).



In the absence of this value, it can be estimated with data retrieved from the last bills using the simplified formula: Energy cost = (Total amount of bills [€]) / (Total amount of energy consumed [Smc]). In reality, the method is simplified because there are a number of fixed costs in the bill that are independent of actual fuel consumption. The precise calculation is beyond the scope of this manual.

#### 7.13 ELE-COST (standard: 0.20 - settable: 0/5)

Defines the cost of electricity used to power the unit (in €/kWh, from a bill).



In the absence of this value, it can be estimated with data retrieved from the last bills using the simplified formula: Energy cost = (Total amount of bills [€]) / (Total amount of energy consumed [Smc]). In reality, the method is simplified because there are a number of fixed costs in the bill that are independent of actual fuel consumption. The precise calculation is beyond the scope of this manual.

The unit manages the AHS setpoint dynamically with a 0-10V signal, through the maximum and minimum setpoint parameters set in the boiler.

#### 7.14 MAX\_SETHEATER (standard: 75 - settable: 0/75)

Defines the maximum setpoint value that can be reached by the boiler, which is used to control the 0-10V signal.

#### 7.15 MIN\_SETHEATER (standard: 30 - settable: 0/80)

Defines the minimum setpoint value that can be reached by the boiler, which is used to control the 0-10V signal.

#### 7.16 MAX\_SIGHEATER (standard: 10 - settable: 0/10)

Defines the signal voltage associated with the maximum setpoint value that can be set in the boiler.

#### 7.17 MIN\_SIGHEATER (standard: 3 - settable: 0/10)

Defines the signal voltage associated with the minimum setpoint value that can be set in the boiler.

#### 7.18 DELTATSOL (standard: 10 - settable: 5/20)

Defines the range between the solar circuit temperature (Tsol) and the DHW storage tank temperature (T5) which, if the solar function is activated, starts the Pump\_s pump. The pump is switched on when DELTATSOL < Tsol - T5.

### 9.2.8 Holiday away function settings

#### ► MENU > FOR SERVICEMAN > 8.HOLIDAY AWAY SETTING

The Holiday Away function can be used during long periods of absence from home and prevents the system from freezing and activating before returning home.

#### 8.1 T1S\_HA\_H (standard: 25 - settable: 20/25)

Defines the water supply temperature setpoint (T1S) for the Holiday Away function.

#### 8.2 T5S\_HA\_DHW (standard: 25 - settable: 20/25)

Defines the DHW storage tank temperature setpoint (T5S) for the Holiday Away function.

### 9.2.9 Serviceman contact settings

#### ► MENU > FOR SERVICEMAN > 9.SERVICE CALL

Serviceman contacts can be stored so that they are always at hand in case of need.

#### PHONE NO.

Stores a phone number.

#### MOBILE NO.

Stores a mobile phone number.



To change numbers from the keypad, use the  buttons. The maximum number of characters is 14, for larger numbers you can select empty cells.

### 9.2.10 Restore factory settings

#### ► MENU > FOR SERVICEMAN > 10.RESTORE FACTORY SETTINGS

The parameters can be restored to the factory settings.

### 9.2.11 Test mode settings

#### ► MENU > FOR SERVICEMAN > 11.TEST RUN

The test mode is used to check operation of the valves, air vent, pumps, Heating, Cooling and DHW.



In this mode, the keypad is disabled with the exception of the  button. You can exit the test at any time by pressing this button.

#### 11.1 POINT CHECK

Used to check the operation of a number of components.

- Select the component from the menu, to forcibly start it.

if it does not work:

- Check its electrical connection.

#### NOTICE

#### Damage of unit due to air in the DHW tank

Before activating the function:

- Make sure the DHW tank and the system are filled with water and the air has been discharged.

- Navigate through the components to be tested with .

- Force activation of the component by setting it to **ON** and pressing .

The components that can be activated are:

- **3WAY-VALVE 1:** 3-way DHW diverter valve
- **3WAY-VALVE 2:** 3-way diverter valve for unmixed double zone systems
- **PUMP\_I:** primary circuit pump (P\_i)
- **PUMP\_O:** secondary circuit pump (P\_o)
- **PUMP\_C:** mixed circuit pump (P\_c)
- **PUMPSOLAR:** solar circuit pump (P\_s)
- **PUMPDHW:** DHW recirculation pump (P\_d)
- **TANK HEATER:** DHW storage tank heater (TBH)
- **3-WAY VALVE 3:** 3-way valve for double zone systems for unmixed zone 2 (SV3)



In double zone systems with one mixed zone, SV2 is not available.

#### 11.2 AIR PURGE

Starts the vent cycle, which eliminates air in the water circuit that can cause the unit to malfunction.



Before activating the function:

- Open the vent valve.

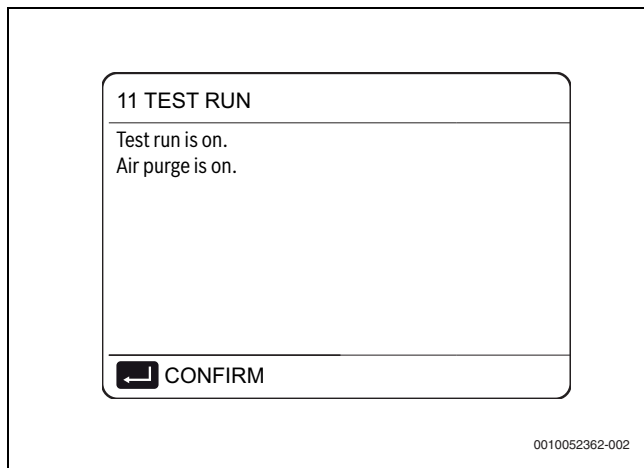

Fig. 135 11.2 AIR PURGE

The logic establishes that:

- the 3-way valve (SV1) opens and the 2-way valve (SV2) closes
- after 60 seconds, the flow switch switches off and the unit pump (P\_i) switches on for 10 minutes
- the pump stops, the 3-way valve closes and the 2-way valve opens
- after 60 seconds, the unit pump (P\_i) and the secondary pump (P\_o) switch on
- the pumps stay on for 20 minutes



Check the cause of any errors shown on the display during the procedure.

### 11.3 CIRCULATED PUMP RUNNING

Starts the unit's circulation pump.

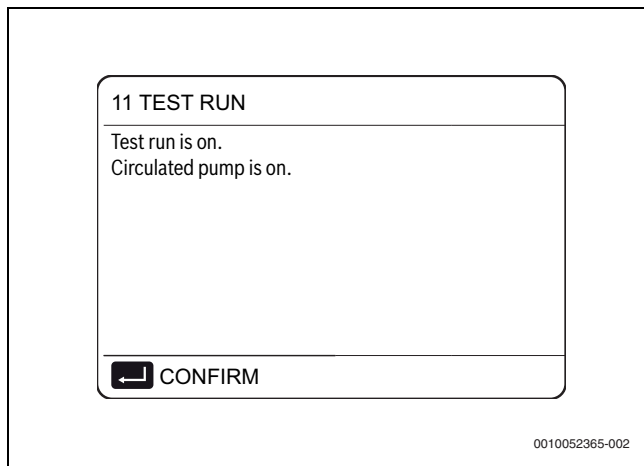

Fig. 136 11.3 CIRCULATED PUMP RUNNING

The logic establishes that:

- all running components are stopped
- after 60 seconds, the 3-way valve (SV1) opens and the 2-way valve (SV2) closes
- after 60 seconds, if the flow switch detects adequate water flow, the unit's pump switches on (P\_i)
- after 30 seconds, the flow switch checks the water flow: if it is adequate, the pump runs for 3 minutes
- the pump stops, after 60 seconds the 3-way valve closes and the 2-way valve opens
- after 60 seconds, the unit pump (P\_i) and the secondary pump (P\_o) switch on

- after 2 minutes the flow switch checks the water flow again:
  - if it is adequate, the pumps stay on until the next keypad command
  - if it is inadequate for at least 15 seconds, the pumps stop and error E8 is displayed; the pumps stay on for 10 minutes



Check the cause of any errors shown on the display during the procedure.

### 11.4 COOL MODE RUNNING

Starts the unit in Cooling mode, so that system operation can be checked.

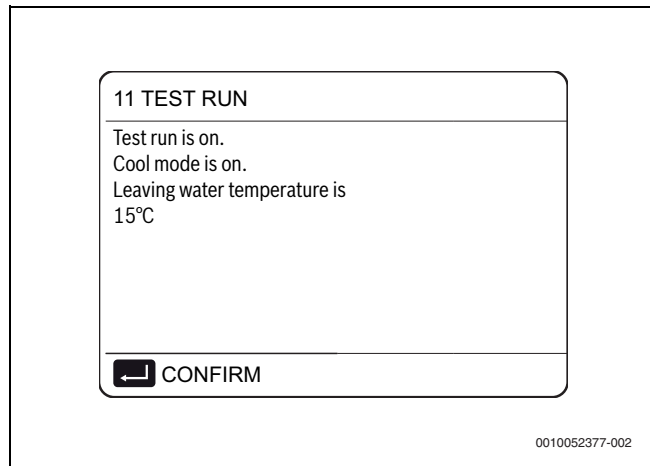

Fig. 137 11.4 COOL MODE RUNNING

The logic establishes that:

- the unit switches on in Cooling mode, with water supply setpoint at 7 °C
- the actual water supply temperature is shown on the HMI display
- the unit continues to operate until the setpoint is reached or for 10 minutes



Check the cause of any errors shown on the display during the procedure.

### 11.5 HEAT MODE RUNNING

Starts the unit in Heating mode, so that system operation can be checked.

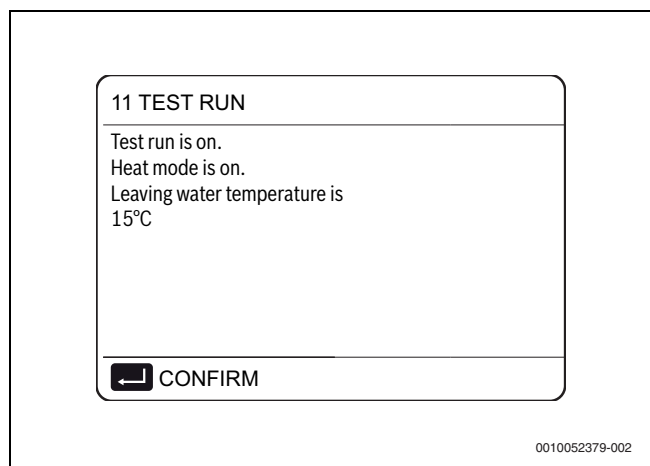

Fig. 138 11.5 HEAT MODE RUNNING

The logic establishes that:

- The unit switches on in Heating mode, with water supply setpoint at 35 °C.
- The actual water supply temperature is shown on the HMI display after 10 minutes:
  - If present, the backup boiler (AHS) starts in support of the heat pump. If the conditions for exiting the function are not reached, the boiler continues to operate for 10 minutes, then switches off.
  - If present, the backup electric heater (IBH) starts in support of the heat pump. If the conditions for exiting the function are not reached, the heater continues to operate for 3 minutes, then switches off.
- The unit continues to operate until the setpoint is reached or for 30 minutes.



Check the cause of any errors shown on the display during the procedure.

### 11.6 DHW MODE RUNNING

Starts the unit in DHW mode, so that system operation can be checked.

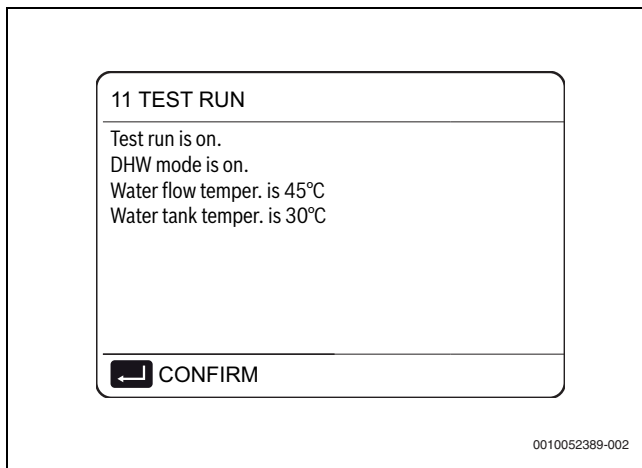

Fig. 139 11.6 DHW MODE RUNNING

The logic establishes that:

- the unit starts in DHW mode, with a DHW setpoint of 55 °C
- the actual water and DHW storage tank supply temperatures are shown on the HMI display
- after 10 minutes, if present, the storage tank electric heater (TBH) starts in support of the heat pump. If the conditions for exiting the function are not reached, the heater continues to operate for 3 minutes, then switches off
- the unit continues to operate until the setpoint is reached or for 20 minutes



Check the cause of any errors shown on the display during the procedure.

### 9.2.12 Special function settings

#### ► MENU > FOR SERVICEMAN > 12. SPECIAL FUNCTION

Special functions can be used during installation or maintenance to better manage or access the system, e.g. on first start-up to run a radiant floor drying cycle or when the unit is restarted after being OFF for a long period.



In this mode, the keypad is disabled.

### 12.1 PREHEATING FOR FLOOR

The function can be useful when the distribution system consists of a radiant floor.

#### NOTICE

#### Risk of damaging the floor!

If Heating mode is activated on a floor that still contains a considerable amount of water, there is a risk that it will warp or crack.

- Carry out a preheating cycle, during which the temperature of the water supplied to the floor is gradually raised.



If this is the first time the unit has been started up, before activating this function:

- Run the air vent function (indicated in this paragraph), in order to avoid malfunctions or damage to the system.

The operating logic is shown in the following diagram:

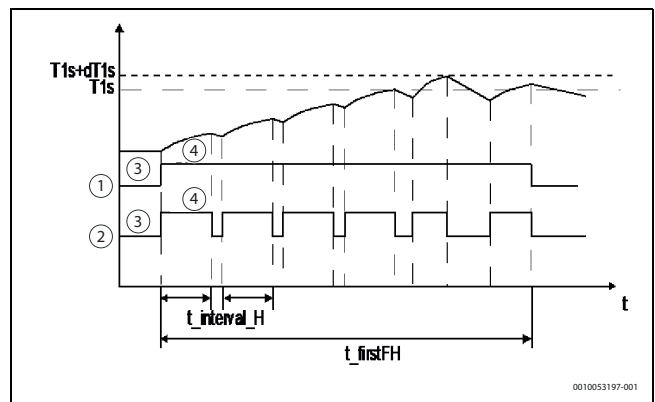

Fig. 140 12.1 PREHEATING FOR FLOOR

- [1] Pump
- [2] Compressor
- [3] Off
- [4] On

The parameters that can be set for this function are:

- **T1S (standard: 25 - settable: 25/35):**  
Defines the water supply setpoint temperature for the floor preheating function.
- **t\_frisFH (standard: 72 - settable: 48/96):**  
Defines how long the floor preheating function runs for.

The HMI display shows the water supply temperature and the operating time of the function.

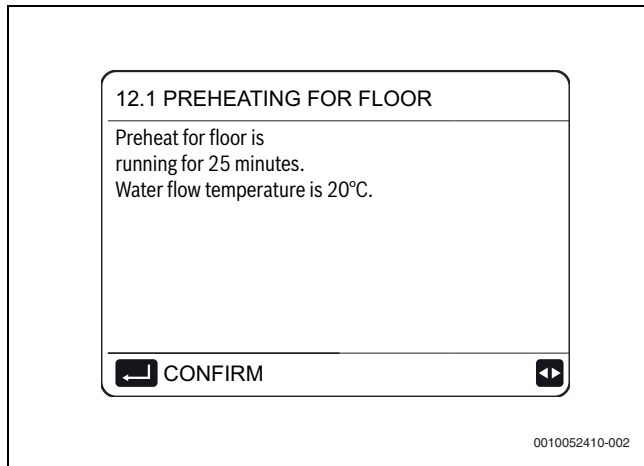

Fig. 141 12.1 PREHEATING FOR FLOOR

You can forcibly exit the function by pressing .

### 12.2 FLOOR DRYING UP

The function can be useful for newly installed radiant floor distribution systems.

**NOTICE**

**Risk of damaging the floor!**

During the first start-up in Heating mode, condensate can form in the floor slab or under the floor, which may cause the floor to warp or break.

- ▶ Carry out a drying cycle at the first start-up, during which the temperature of the water supplied to the floor is adjusted, as shown in the following diagram.

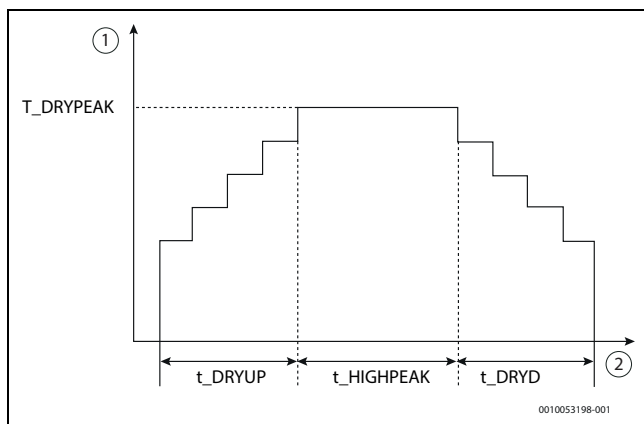

Fig. 142 Drying cycle diagram

[1]  $T_{Water}$

Maximum current limitation [A] according to the selected profile:

Size	#							
	1	2	3	4	5	6	7	8
CS2000AWF 4 R-S - CS2000AWF 6 R-S	18	16	15	14	13	12	12	12
CS2000AWF 8 R-S - CS2000AWF 10 R-S	19	18	16	14	12	12	12	12
CS2000AWF 12 R-S/CS2000AWF 12 R-T - CS2000AWF 14 R-S/CS2000AWF 14 R-T	30	28	26	24	22	20	18	16
CS2000AWF 16 R-S - CS2000AWF 16 R-T	30	29	27	25	23	21	19	17
CS2000AWF 12 R-S/CS2000AWF 12 R-T - CS2000AWF 16 R-S/CS2000AWF 16 R-T	14	13	12	11	10	9	9	9
CS2000AWF 18 R-T	18	17	16	15	14	13	12.5	12
CS2000AWF 22 R-T	21	20	19	18	17	16	15	14

If this is the first time the unit has been started up, before activating this function:

- ▶ Run the air vent function (indicated in this paragraph), in order to avoid malfunctions or damage to the system.

If the heat pump is out of service, the function continues using the boiler or backup electric heater, if present and enabled.

The parameters that can be set for this function are:

- **WARM UP TIME( $t_{DRYUP}$ ) (standard: 8 - settable: 4/15):**  
Defines the number of days over which the water supply temperature is gradually increased.
- **KEEP TIME( $t_{HIGHPEAK}$ ) (standard: 5 - settable: 3/7):**  
Defines the number of days over which the water supply temperature is kept constant.
- **TEMP.DOWN TIME( $t_{DRYD}$ ) (standard: 5 - settable: 4/15):**  
Defines the number of days over which the water supply temperature is gradually decreased.
- **PEAK TEMP.( $t_{DRYPEAK}$ ) (standard: 45 - settable: 30/55):**  
Defines the maximum water supply temperature of the function.
- **START TIME (standard: current time - settable: 00:00/23:30):**  
Defines the start time of the function.
- **START DATE (standard: today - settable: 1-1-2000/31-12-2099):**  
Defines the start date of the function.

The HMI display shows the water supply temperature and the operating time of the function.

You can forcibly exit the function by pressing .

### 12.3 EMPTY AHS CIRCUIT

Reserved parameter, do not change.

#### 9.2.13 Automatic restart settings

- ▶ MENU > FOR SERVICEMAN > 13. AUTO RESTART

The unit stores the user settings even after the power supply has been cut off. This function sets whether the unit should automatically restart or remain on stand-by when the power supply is restored after a power failure.

#### 13.1 COOL/HEAT MODE (standard: YES - settable: YES/NO)

Defines whether the automatic restart function is switched on for Cooling and Heating modes.

#### 13.2 DHW MODE (standard: YES - settable: YES/NO)

Defines whether the automatic restart function is switched on for DHW mode.

#### 9.2.14 Unit's power supply limitation settings

- ▶ MENU > FOR SERVICEMAN > 14. POWER INPUT LIMITATION

This function is used to limit the current consumed by the unit according to predefined profiles.

Size	1	2	3	4	#	5	6	7	8
CS2000AWF 26 R-T	24	23	22	21	20	19	18	17	17
CS2000AWF 30 R-T	28	27	26	25	24	23	22	21	21

Table 38

**14.1 POWER INPUT LIMITATION (standard: NO - settable: NO/1 to 8)**

Enables the function and defines the maximum consumption profile.



By enabling the function, unit performance will be less than nominal.

**9.2.15 Unit input signal settings**

► **MENU > FOR SERVICEMAN > 15. INPUT DEFINE**

This function is used to adjust and set the unit input signal and probe functions according to the requirements of the system.

The parameters that can be set for this function are:

**M1M2 (standard: 0 - settable: 0/1/2)**

Defines what the potential-free contact M1M2 should control (0 = remote ON/OFF; 1 = boiler electric heater (TBH); 2 = backup boiler).

**SMART GRID (standard: NO - settable: YES/NO)**

Enables/disables the Smart Grid function (→ Chapter 8.8, page 65).

**Tw2 (standard: NO - settable: YES/NO)**

Enables/disables reception of the signal from the secondary circuit supply water temperature probe (Tw2).

**Tbt1 (standard: NO - settable: YES/NO)**

Enables/disables reception of the signal from the inertial storage tank temperature probe Tbt1.

**Tbt2 (standard: NO - settable: YES/NO)**

Reserved parameter, do not change.

**Ta (standard: NO - settable: YES/NO)**

Enables/disables reception of the signal from the room air temperature probe in the HMI (Ta).

**Ta-adj (standard: -2 - settable: -10/10)**

Sets a correction value to be considered on the value detected by the Ta probe.

**SOLAR INPUT (standard: 0 - settable: 0/1/2)**

In the presence of a solar thermal system, it defines how this should be managed by the unit.

- 0 = disabled
- 1 = the unit detects the temperature of the water in the solar circuit (Tsolar) and controls the solar pump according to its own logic
- 2 = the unit receives an external ON/OFF signal (contacts SL1 / SL2, e.g. from the solar controller) and controls the solar pump

**F-PIPE LENGTH (standard: 0 - settable: 0/1)**

Reserved, do not use.

**RT/Ta\_PCB (standard: 0 - settable: 0/1)**

Reserved, do not use.

**Pump\_i silent mode (standard: NO - settable: YES/NO)**

Enables/disables the silent function for the unit's pump, which reduces the pump output by 5% to make the unit quieter.

**DFT1/DFT2 (standard: 0 - settable: 0/1)**

Defines what type of signal contacts DFT1/DFT2 should manage (0 = defrosting; 1 = alarm state).

**9.2.16 Cascade system settings**

► **MENU > FOR SERVICEMAN > 16.CASCADE SET**

Used to set the unit as part of a cascade system.

**16.1 PER\_START (standard: 10% - settable: 10%/100%)**

Defines the percentage of units that are activated at system start-up.



The percentage refers to the total number of units in the cascade system, including both Master and Slave units.

**16.2 TIME\_ADJUST (standard: 5 - settable: 1/60)**

Defines the minutes after which the Master unit checks whether a Slave unit is switched on/off.

**16.3 ADDRESS RESET (standard: FF - settable: 0/15)**

Sets the unit address, for Slave units only.



Slave units are auto-addressing and do not require manual address setting. FF is equivalent to setting an invalid address.

- If necessary, set the address manually.

**9.2.17 Other HMI settings**

► **MENU > FOR SERVICEMAN > 17.HMI ADDRESS SET**

If the unit is controlled with home automation or BMS systems, it is possible to limit access from the HMI to only certain parameters.

**17.1 HMI SET (standard: 0 - settable: 0/1)**

Defines whether the HMI has limited settings (parameter = 1): in this case it can only manage ON/OFF, mode change and setpoint.

**17.2 HMI ADDRESS FOR BMS (standard: 1 - settable: 1/16)**

Defines the unit address for management with BMS systems.



This parameter is only manageable if the unit has not been limited in point 17.1 HMI SET.

**17.3 STOP BIT (standard: 1 - settable: 1/2)**

Defines the data exchange protocol between the BMS software and the HMI (it must be the same for both).

**9.2.18 Climate curve setting**

Climate curves can be selected on the user interface:

- **MENU > DEFAULT TEMPERATURES > CLIMATE TEMP. SET.**

DEFAULT TEMPERATURES		
DEFAULT TEMP.	CLIMATE TEMP. SET.	ECO MODE
LOW. TEMP.COOL MODE ZONE 1		OFF
LOW. TEMP.HEAT MODE ZONE 1		OFF
LOW. TEMP.COOL MODE ZONE 2		OFF
LOW. TEMP.HEAT MODE ZONE 2		OFF
ON/OFF	ON/OFF	

0010052422-002

Fig. 143 CLIMATE TEMP. SET.

During the year, the heat load of the building is highly variable depending on factors such as outdoor air temperature, insulation, thermal inertia, crowding, etc.

Recommendation in Heating mode:

- ▶ use the setpoint setting on the automatically controlled water supply or on the indoor air (which controls the water supply with the climate curve).

Recommendation in Cooling mode:

- ▶ Work on the latent refrigeration load by dehumidifying.
- ▶ Operate the radiant or terminal distribution using the setpoint setting on the fixed water supply.

One of the default curves can still be used.

One of the curves designed to optimise the system can be selected with the user interface:

- 8 default curves for Heating mode on systems with radiant distribution

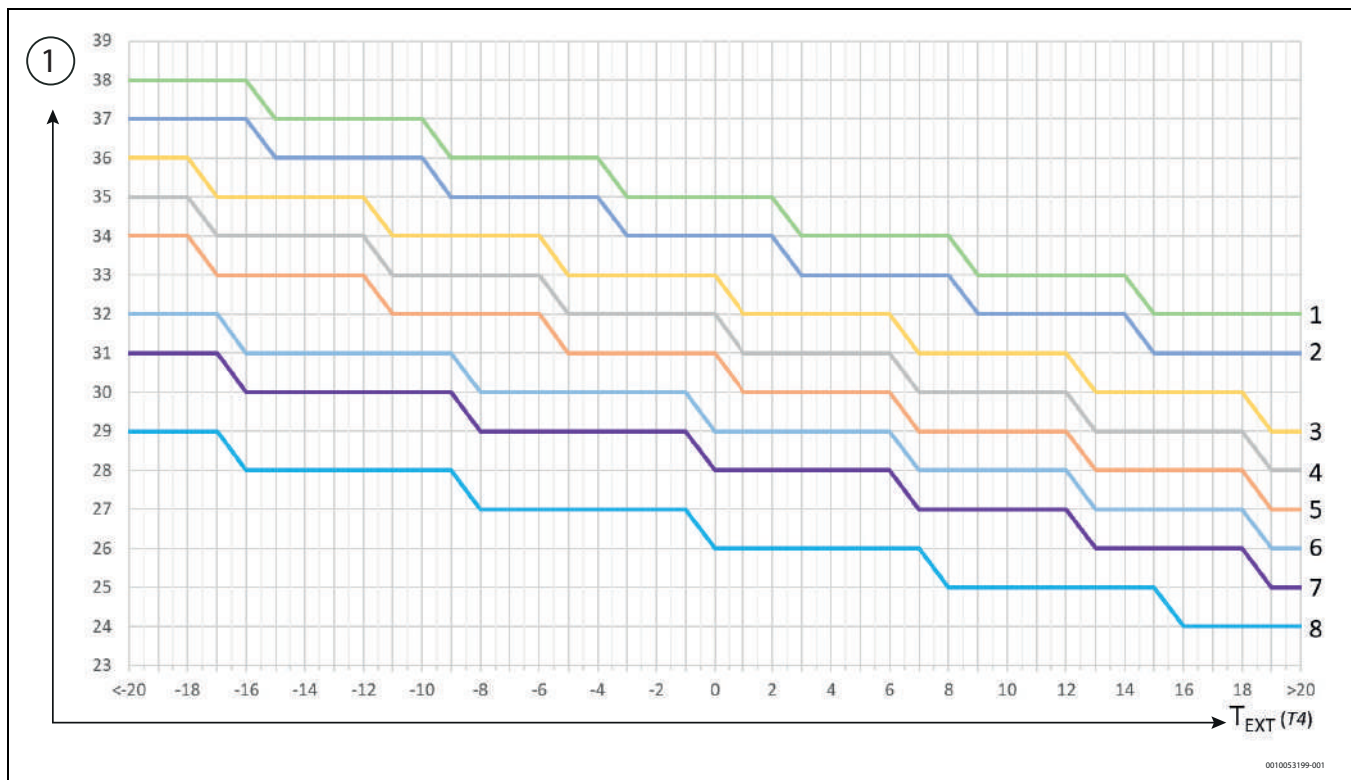



Fig. 144 Heating mode on systems with radiant distribution

[1] T<sub>Water supply</sub> (T<sub>1S</sub>)

 The default curve for Heating mode is 3, for ECO mode it is 6.

- 8 default curves for Heating mode on systems with terminal distribution

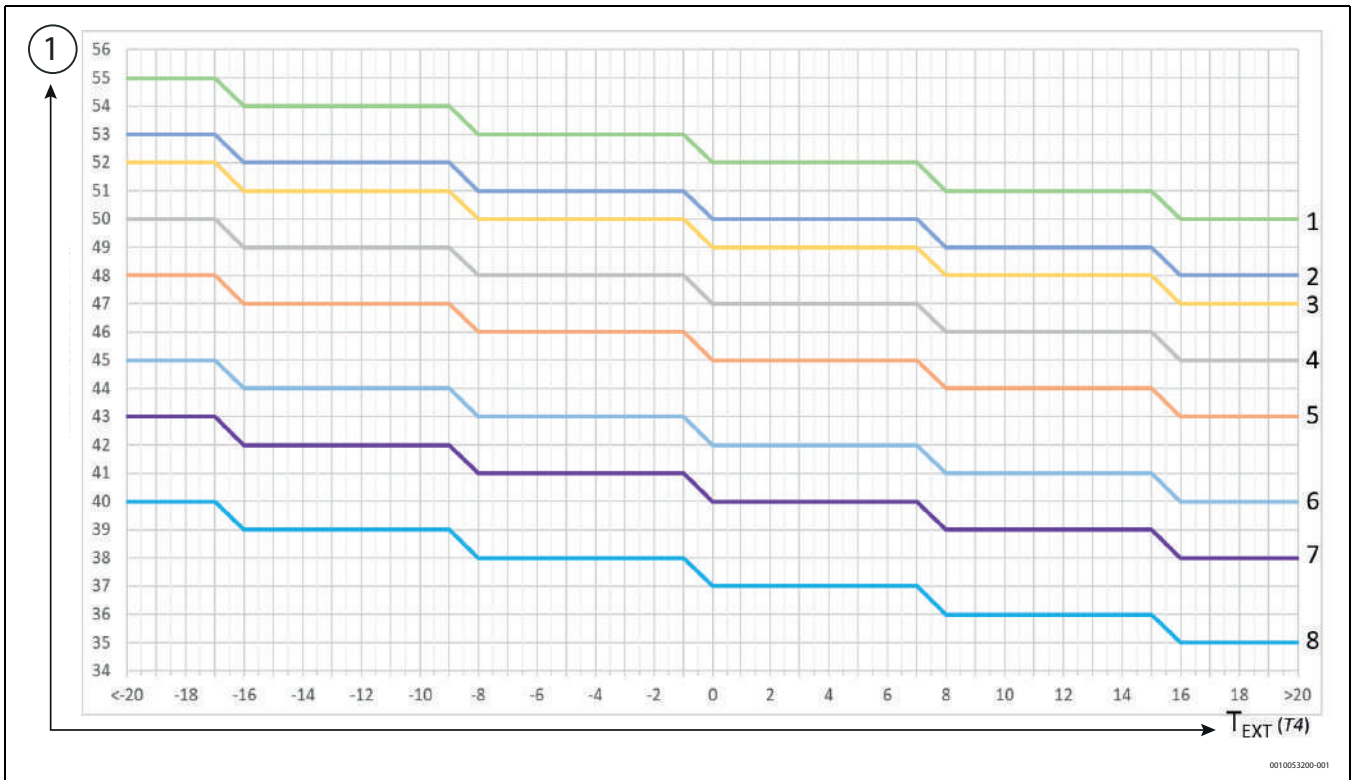

Fig. 145 Heating mode on systems with terminal distribution

[1]  $T_{\text{Water supply}} (T1S)$

- 1 customisable curve, using the outdoor air temperature ( $T4H1$ ,  $T4H2$ ) and water supply ( $T1SETH1$ ,  $T1SETH2$ ) parameters



The default curve for Heating mode is 4, for ECO mode it is 6.

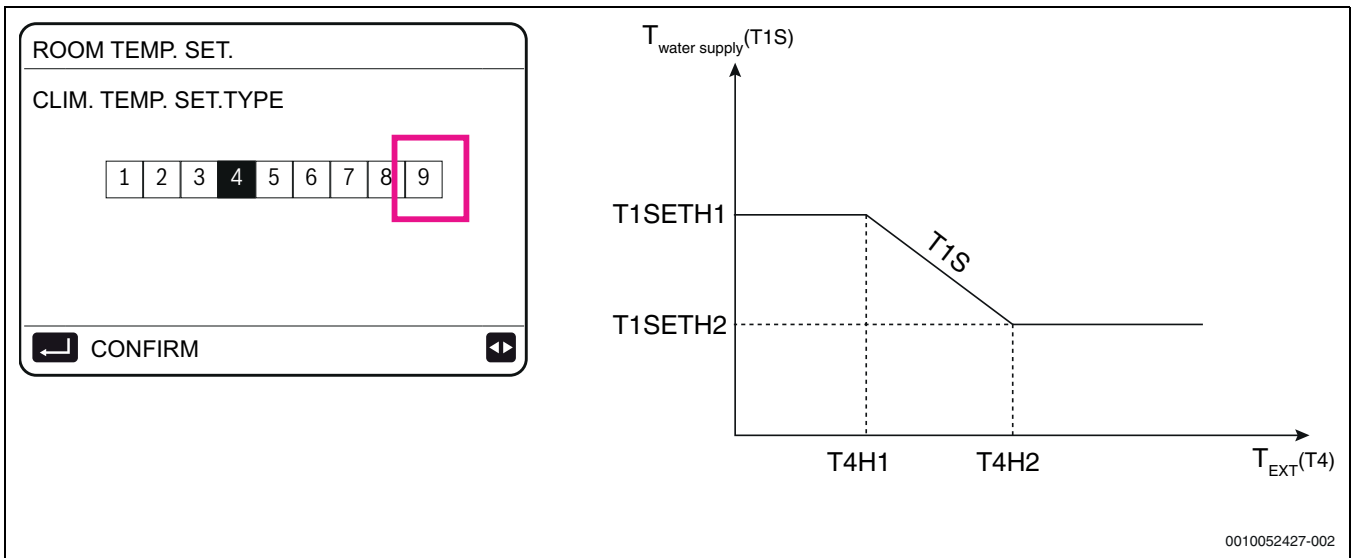

Fig. 146 Customisable curve – outdoor air temperature ( $T4H1$ ,  $T4H2$ ) and water supply ( $T1SETH1$ ,  $T1SETH2$ )

- 8 default curves for Cooling mode on systems with radiant distribution

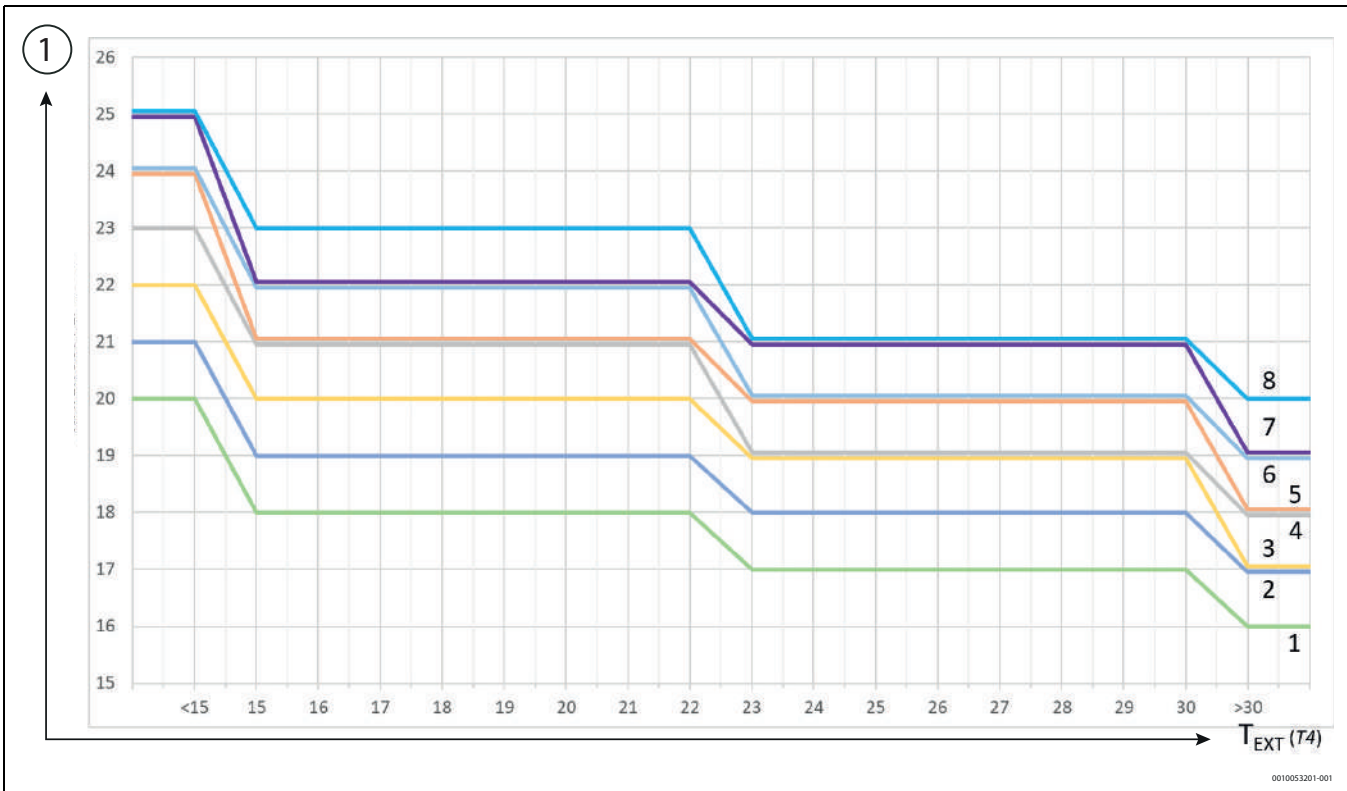

Fig. 147 Cooling mode on systems with radiant distribution

[1]  $T_{\text{Water supply (T1S)}}$

- 8 default curves for Cooling mode on systems with terminal distribution



The default curve for Cooling mode is 4.

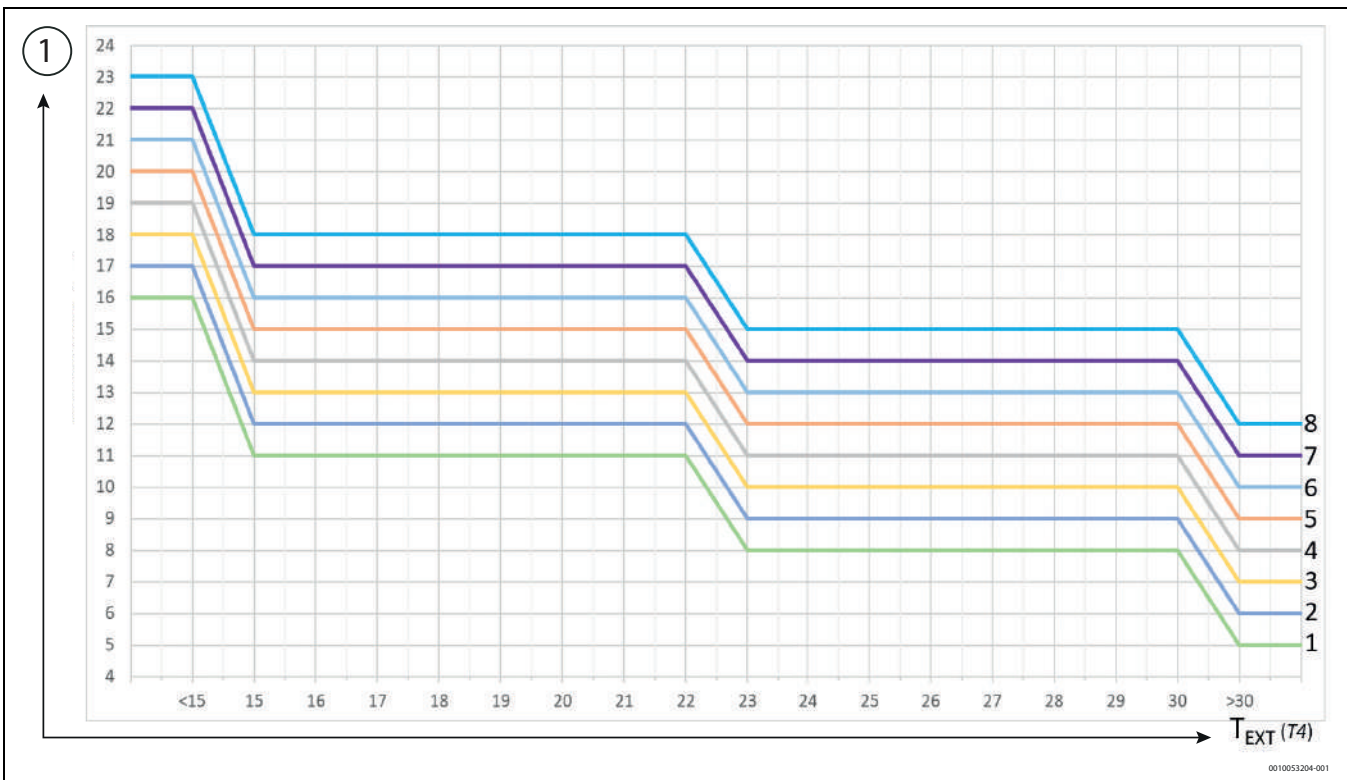

Fig. 148 Cooling mode on systems with terminal distribution

[1]  $T_{\text{Water supply (T1S)}}$



The default curve for Cooling mode is 4.

- 1 customisable curve, using the outdoor air temperature (T4C1, T4C2) and water supply (T1SETC1, T1SETC2) parameters

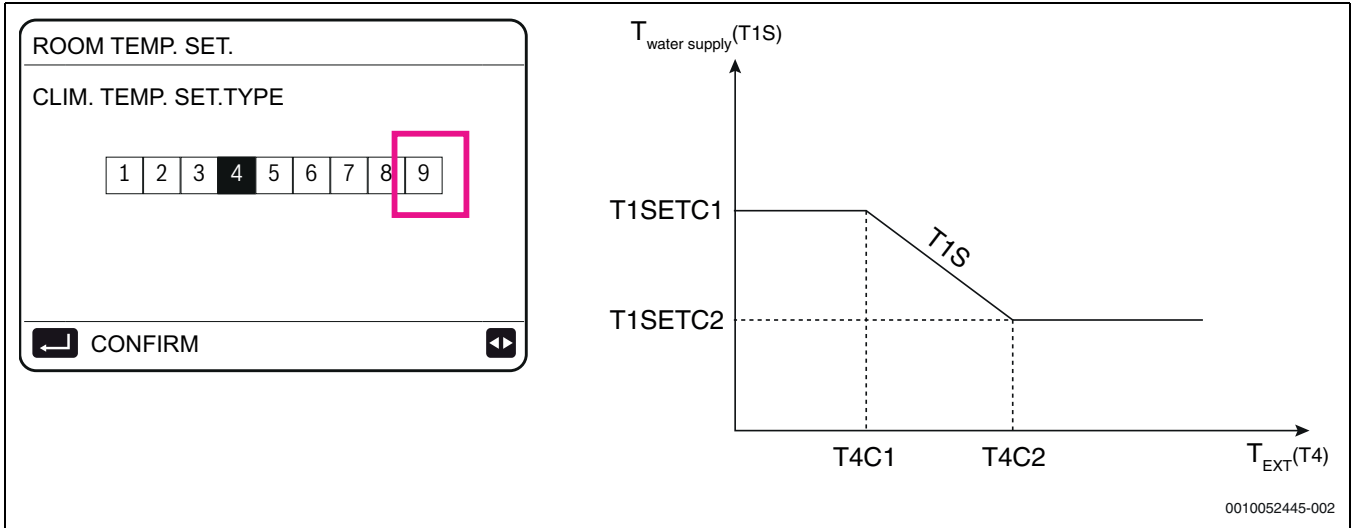

Fig. 149 Customisable curve – outdoor air temperature (T4C1, T4C2) and water supply (T1SETC1, T1SETC2)

## 10 Control

### 10.1 Explanation of buttons

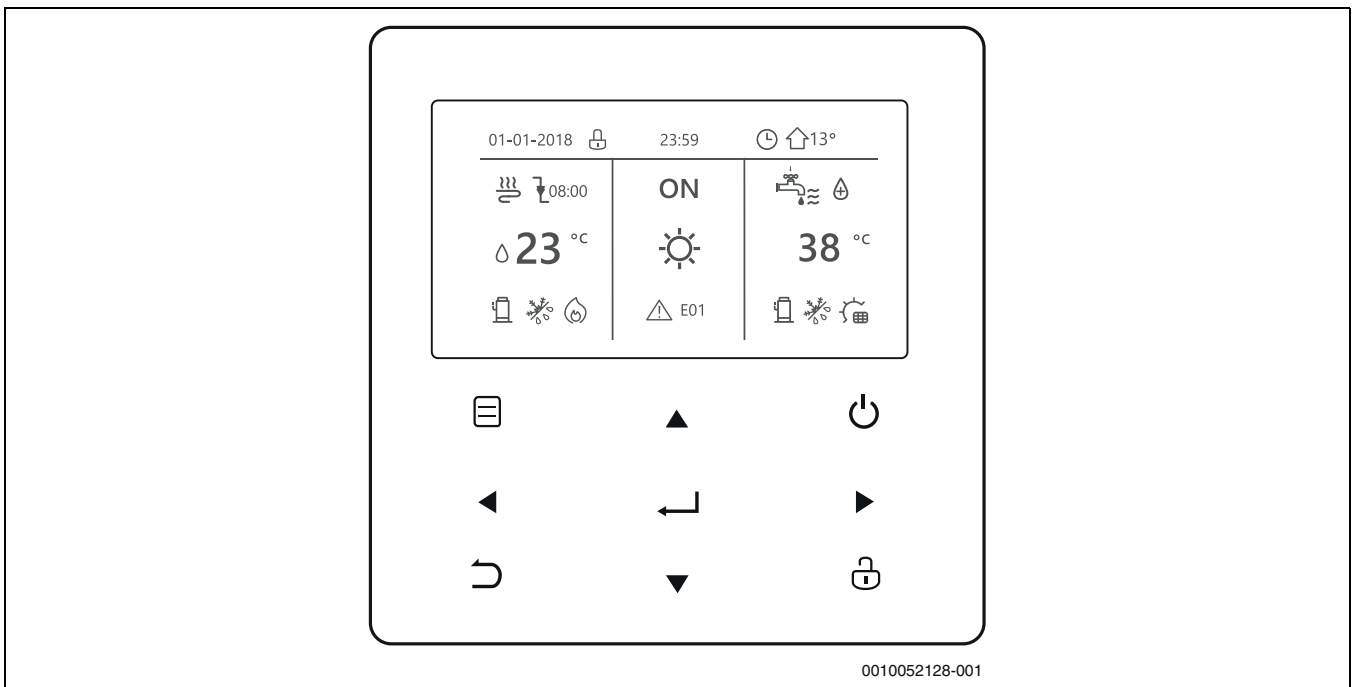

Fig. 150 Keypad

Buttons		Function
	MENU	To open the various menus from the HOME page
	ON/OFF	<ul style="list-style-type: none"> <li>• To switch on/off the heating/cooling modes or DHW mode</li> <li>• To switch on/off the functions in the menu structure</li> </ul>
	UNLOCK	<ul style="list-style-type: none"> <li>▶ Press the button for 3 seconds to Unlock/Lock the keypad</li> </ul> To unlock/lock certain functions such as “DHW temperature control”
	OK	<ul style="list-style-type: none"> <li>• To enter a submenu</li> <li>• To confirm entered values</li> </ul>



Buttons		Function
 	LEFT - RIGHT DOWN - UP	To move the cursor on the screen/navigate in the menu structure/adjust parameter settings
	BACK	To return to the previous level or page ▶ Long button press to return straight to the home page

Table 39 Keypad

**Auto-restart function**

The unit has an auto-restart function:

in the event of a power failure (e.g. blackout), when the power supply is restored the unit restarts at the last selected settings.











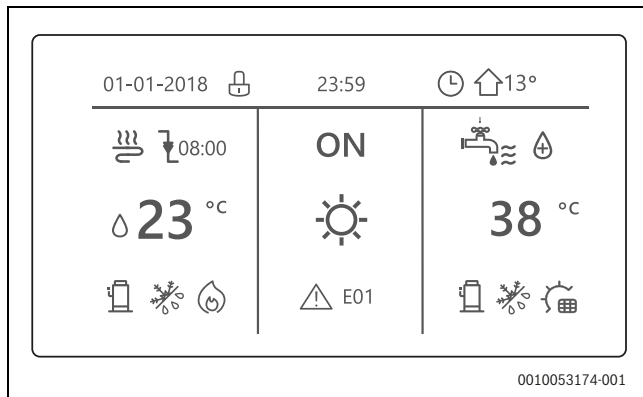























**10.2 Explanation of the display**

Fig. 151 Display

Buttons	Description
	Keypad lock
	At the next scheduled action, the temperature will decrease
	The temperature does not change
	The temperature decreases
	The temperature increases
	Fan coil on
	Fan coil off
	Radiator on
	Radiator off
	Floor heating (radiant panels) on
	Floor heating (radiant panels) off
	System water supply temperature (configurable)
	Heating mode

Buttons	Description
	Cooling mode
	Automatic mode
	Additional heat source
	Electric heater
	Compressor on
	Pump on
	Weekly schedule
	Time schedule
	Outdoor temperature
	Domestic hot water (DHW) on
	Domestic hot water (DHW) off
	Disinfect (anti-legionella) function on
OFF ON	Switch on Switch off
	DHW storage tank temperature
	Solar panel on
	Storage tank electric heater on
	Alarm
	Smart grid mode
	Anti-freeze mode on
	Defrosting mode on
	Holiday away/at home on



Buttons	Description
	Silent mode on
	ECO mode on

Table 40 Keypad



Energy cost	Smart grid	Energy source	Energy absorbed
Free		Photovoltaics	Average
Low		From the network	Average
High		From the network	Peak

Table 41 Energy Cost

The home page changes according to the type of system



Configuration to be provided by the installer..

**Single zone system**

User interface control:

**MENU > FOR SERVICEMAN > 6. ROOM THERMOSTAT > ROOM THERMOSTAT = NO**

Thermostat control:

**MENU > FOR SERVICEMAN > 6. ROOM THERMOSTAT > ROOM THERMOSTAT = ONE ZONE**

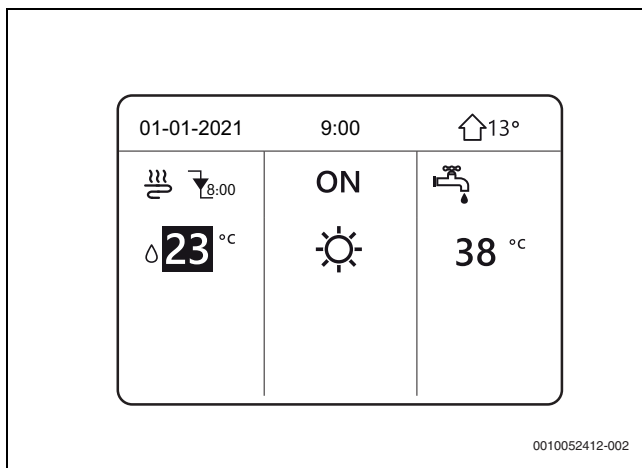

Fig. 152 Single zone system

**Double zone system**

Keypad control:

**MENU > FOR SERVICEMAN > 6. ROOM THERMOSTAT > ROOM THERMOSTAT = NO**

▶ Press .

▶ Select temperature type settings > **DOUBLE ZONE = YES**

Thermostat control:

**MENU > FOR SERVICEMAN > 6. ROOM THERMOSTAT > ROOM THERMOSTAT = DOUBLE ZONE**

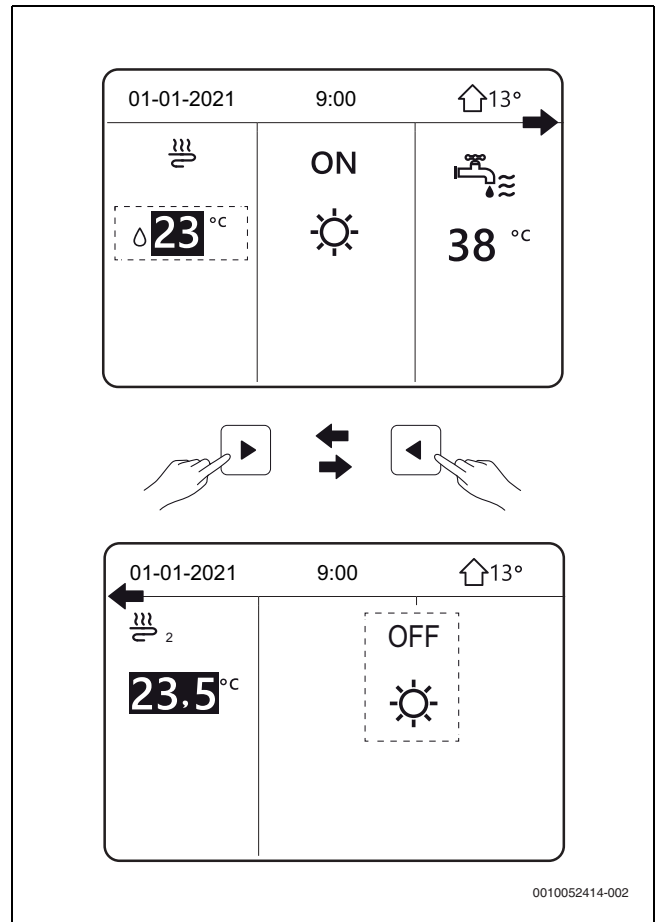

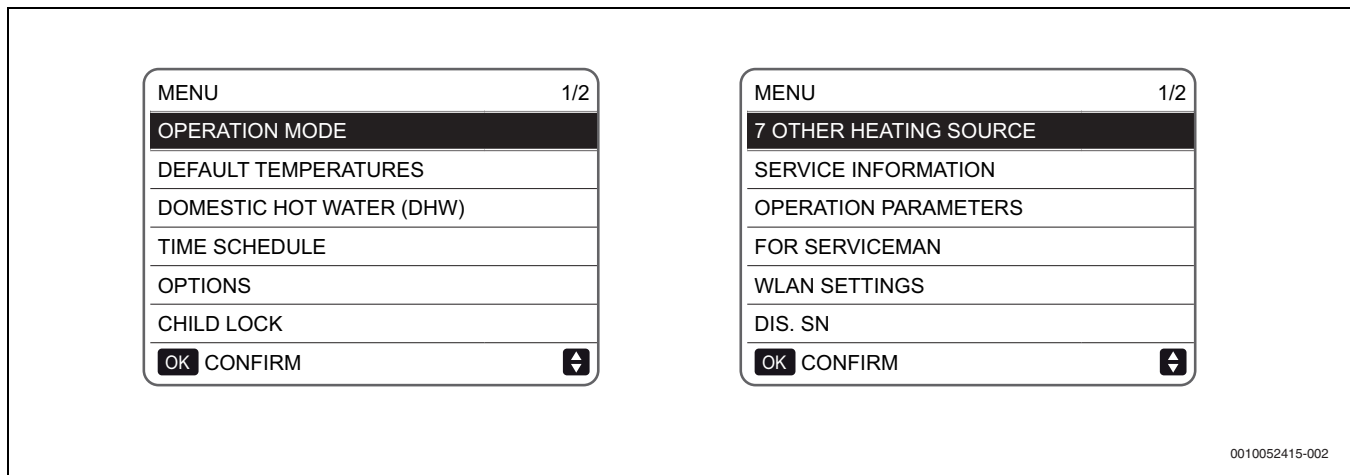

Fig. 153 Double zone system

**10.3 Menu structure**

▶ Press  for 3 seconds to unlock the keypad.



0010052415-002

Fig. 154 Menu

**OPERATION MODE**

- HEAT
- COOL
- AUTO

**DEFAULT TEMPERATURES**

- DEFAULT TEMP.
- CLIMATE TEMP. SET.
- ECO MODE

**DOMESTIC HOT WATER(DHW)**

- DISINFECT (anti-legionella)
- FAST DHW
- HEATED TANK
- DHW PUMP (recirculation))

**TIME SCHEDULE**

- TIMER
- SCHEDULED WEEK
- CHECK SCHEDULE
- CANCEL TIMER

**OPTIONS**

- SILENT MODE
- HOLIDAY AWAY
- HOLIDAY AT HOME
- HEATING BACKUP

**CHILD LOCK**

- ENTER PASSWORD
- COOL/HEAT TEMP. CONTROL
- COOL/HEAT MODE
- DHW TEMP. CONTROL
- DHW MODE ON/OFF

**SERVICE INFORMATION**

- SERVICE
- CODE ERROR
- PARAMETER
- DISPLAY

**OPERATION PARAMETER**

- CONSULTATION ONLY

**FOR SERVICEMAN<sup>1)</sup>**

- ENTER PASSWORD
- DHW MODE SETTING
- COOL MODE SETTING

- HEAT MODE SETTING
- AUTO MODE SETTING
- TEMPERATURE TYPE SETTING
- ROOM THERMOSTAT†
- OTHER HEATING SOURCE
- HOLIDAY AWAY SETTING
- SERVICE CALL
- RESTORE FACTORY SETTINGS
- TEST MODE
- SPECIAL FUNCTION
- POWER INPUT LIMIT
- INPUT DEFINITION
- CASC. SYS.
- HMI ADDRESS SET

**10.4 Home page**

The Home page is the Customer's access point for daily control and varies depending on the system (and the relevant configuration set by the Technician at first start-up).

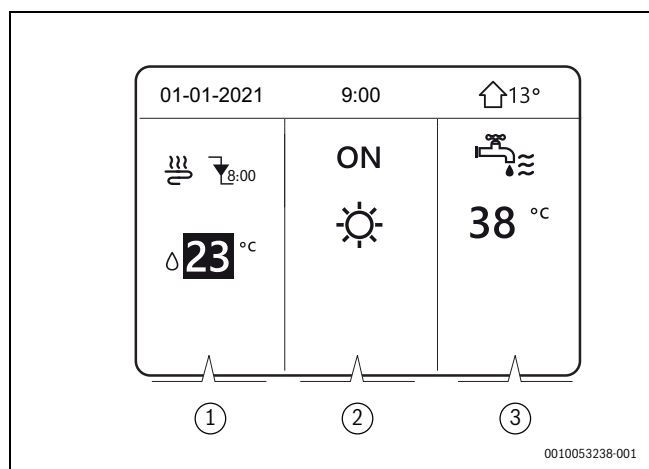

0010053238-001

Fig. 155 Example for a single zone system

- [1] System settings
- [2] ON/OFF and mode set
- [3] DHW settings

1) Access by password is reserved for qualified personnel. Changes to parameters may cause malfunctions

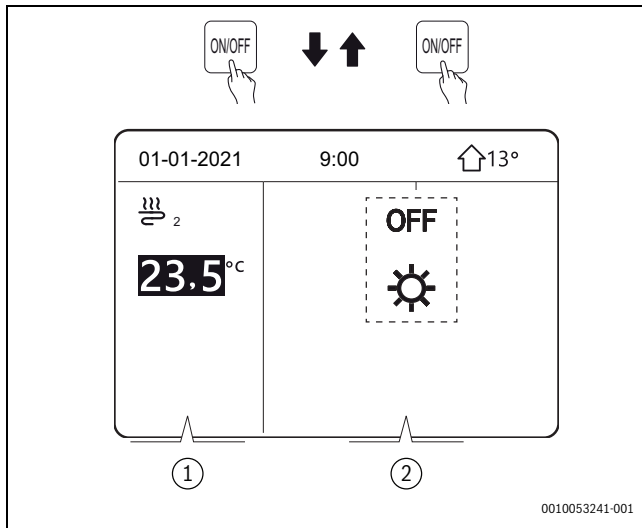

Fig. 156 Example for a double zone system

- [1] System zone 2 settings
- [2] ON/OFF and mode set for system zone 2



Double zone systems have a second page accessible with buttons.

### 10.5 Menu structure

About the menu structure The menu structure allows you to read and configure settings that are NOT intended for everyday use. These instructions describe the information displayed and the operations that can be performed in the menu structure.

To go to the menu structure:

- ▶ Press **MENU** on the keypad.  
The menu structure is displayed.

To navigate in the menu structure:

- ▶ Press to scroll.

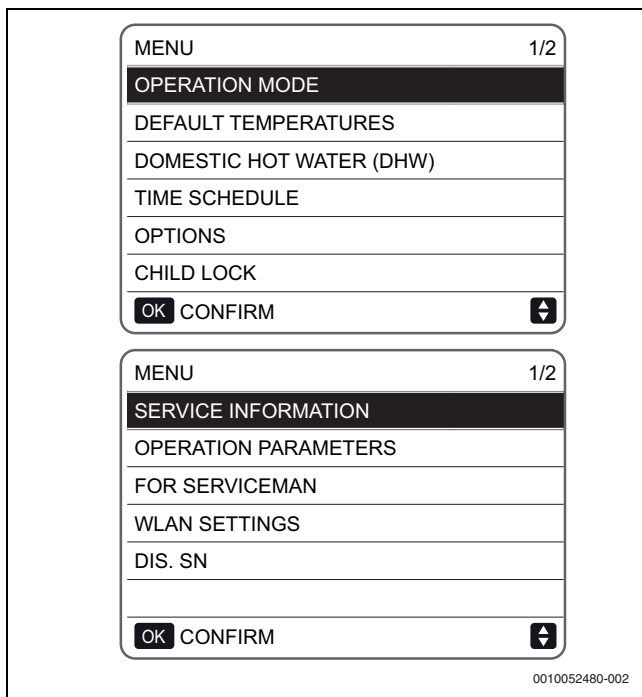

Fig. 157 Menu structure

### 10.6 Unlocking the keypad

If the keypad **UNLOCK** appears on the screen, it means that the keypad is locked.

- ▶ Press any button.  
The will flash.
- ▶ Long press .  
The icon will disappear from the screen and the interface can be checked



The interface locks automatically after a long period of inactivity. The default value is approximately 120 seconds but can be adjusted via the interface (→ Chapter Service information, page 10.17).

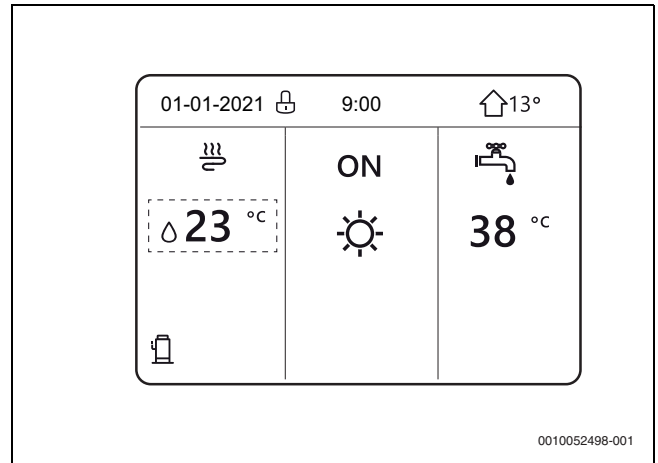

Fig. 158 Locked keypad

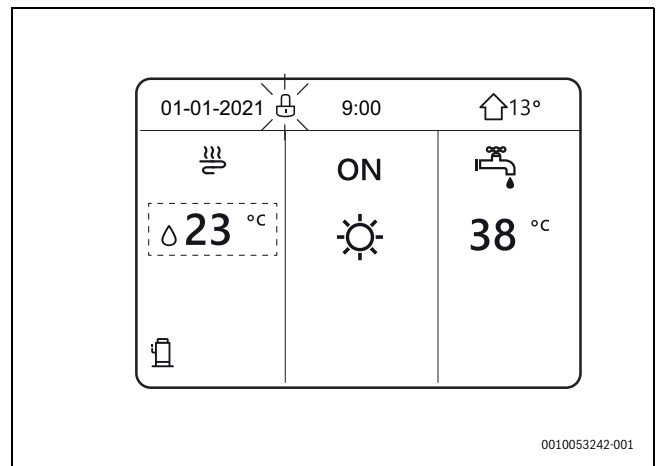

Fig. 159 Locked keypad (flashing)

If the interface is unlocked.

To lock the interface:

- ▶ Long press .

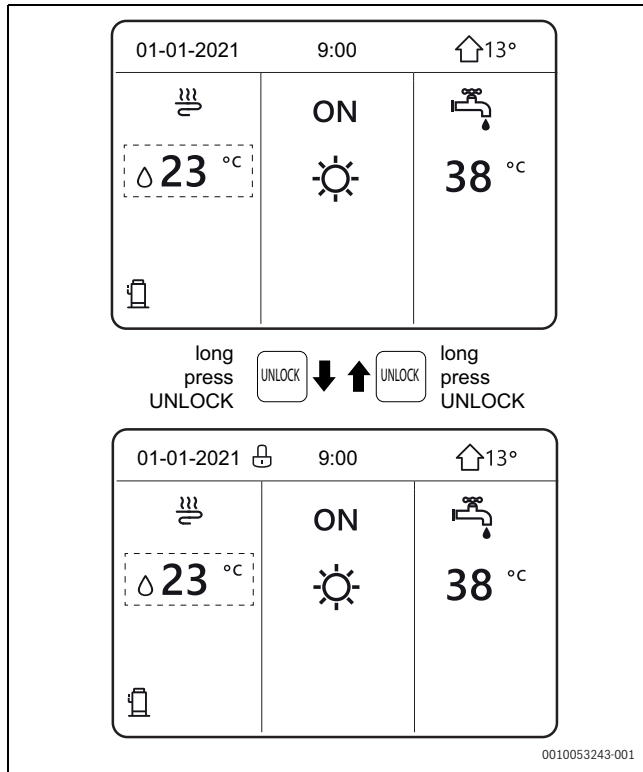

Fig. 160 Lock keypad

### 10.7 Unit ON/OFF

The black selection cursor must not be present when switching the unit on/off.

- ▶ Press for 5 seconds.

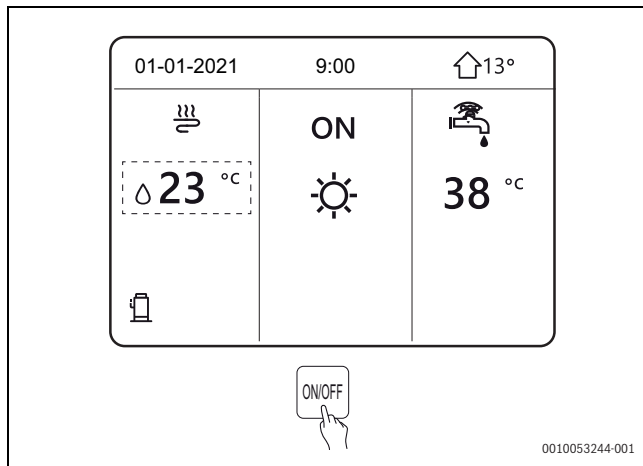

Fig. 161 Unit ON/OFF

### 10.8 Controls OFF/ON

On the interface it is possible to switch on or off the unit for room heating or cooling.



Switching the unit on or off can be controlled from the interface if the room thermostat is set to **NO**.

- ▶ Press or on the page and the black cursor will appear.

When the cursor is on the system temperature side (Cool mode, Heat mode, Auto mode):

- ▶ Press to switch the heating or cooling mode on/off.

- ▶ Press .

The cursor is on the DHW side.

To switch the DHW on/off:

- ▶ Press .

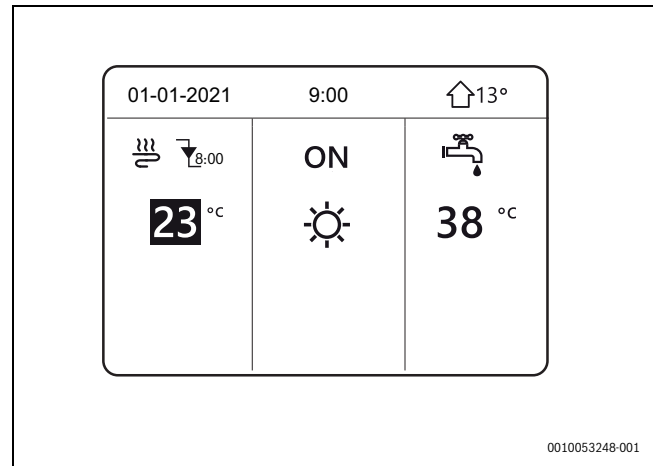

Fig. 162 Black cursor

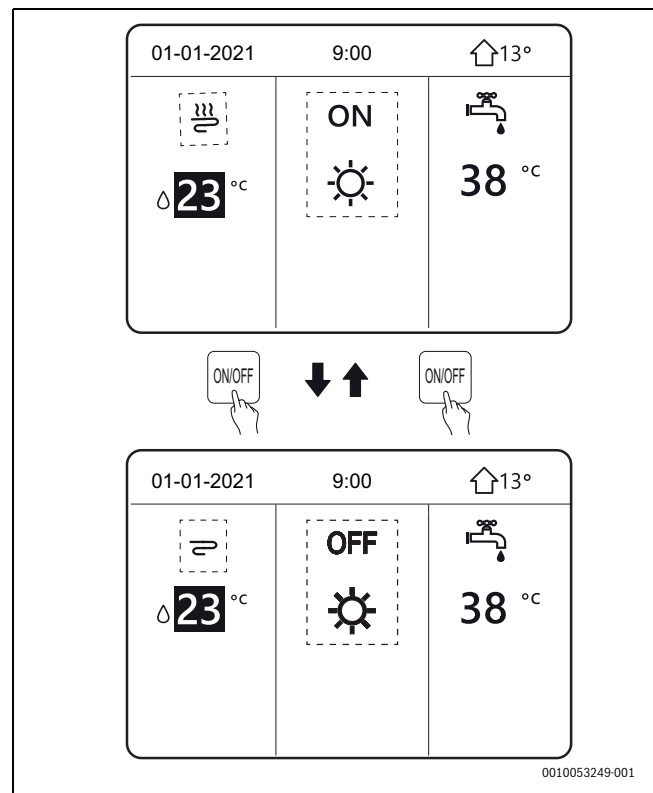

Fig. 163 DHW ON/OFF

If **DHW MODE** setting is set to **NO**, the following pages will be displayed without the DHW function.

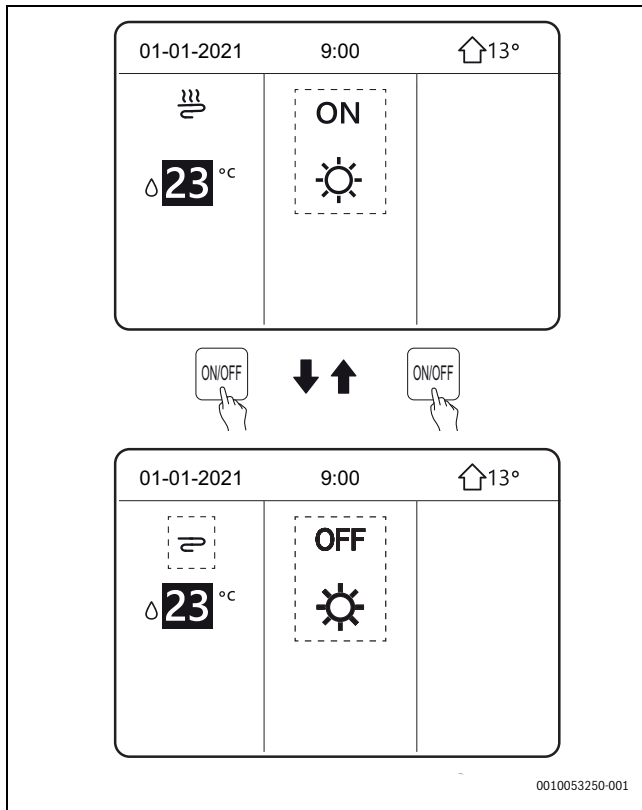



Fig. 164 DHW settings - NO

The room thermostat can be used to switch the unit on or off for heating or cooling the room.

If the room thermostat is set to:

- **DOUBLE ZONE, ONE ZONE** = the unit can be switched on or off with the room thermostat.  
Pressing  on the interface displays the following page.
- **MODE SETTING** = can be switched on or off with the room thermostat and also controls the heating and cooling mode (see **FOR SERVICEMAN** section).

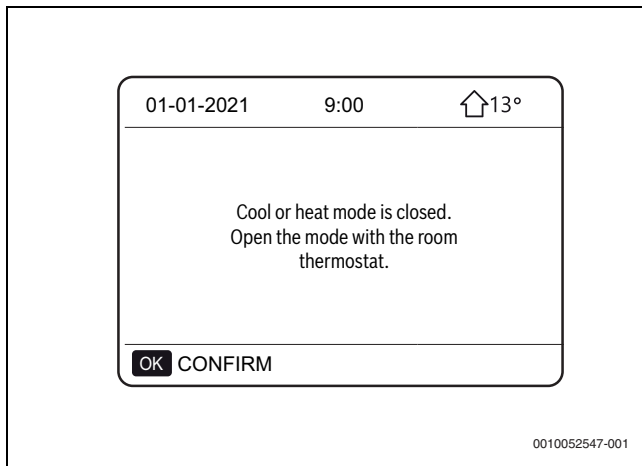



Fig. 165 Room thermostat control

If the room thermostat is set to **NO** (see **FOR SERVICEMAN** section):

- ▶ Press  or  on the page and the black cursor will appear.

When the cursor is on the system temperature side:

- ▶ Press  to switch the fan coils on/off.

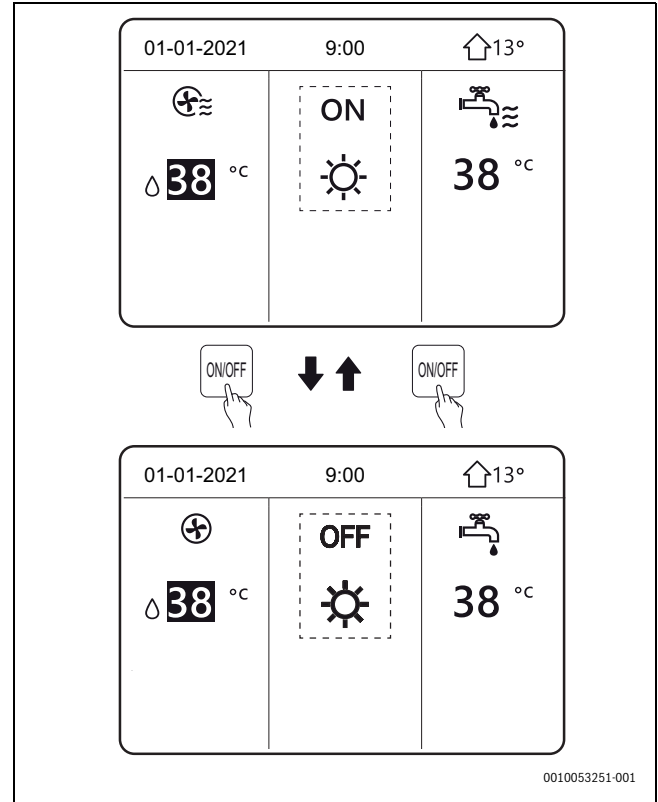



Fig. 166 Fancoil ON/OFF

- ▶ Press  on the page.  
The black cursor will appear.

To switch the radiant panels on/off:

- ▶ Press , when the cursor is on the system temperature side.

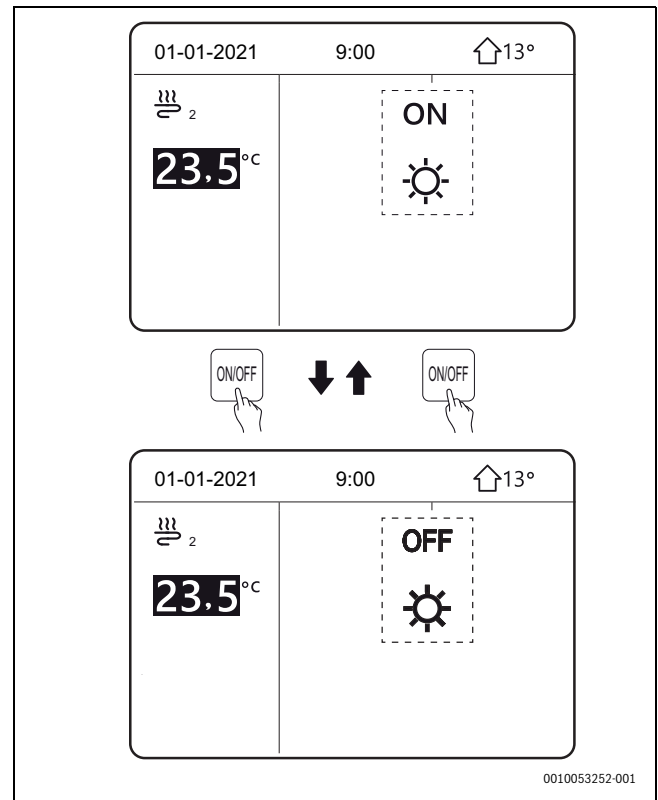



Fig. 167 Radiant panels ON/OFF

On the interface it is possible to switch on or off the unit for domestic hot water production.

- ▶ Press  on the page.  
The black cursor will appear.

To switch the domestic hot water production on/off:

- ▶ Press , when the cursor is on the DHW temperature side.

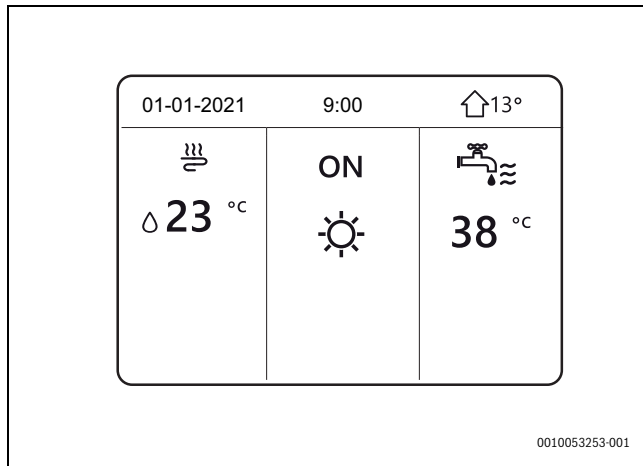

Fig. 168 DHW

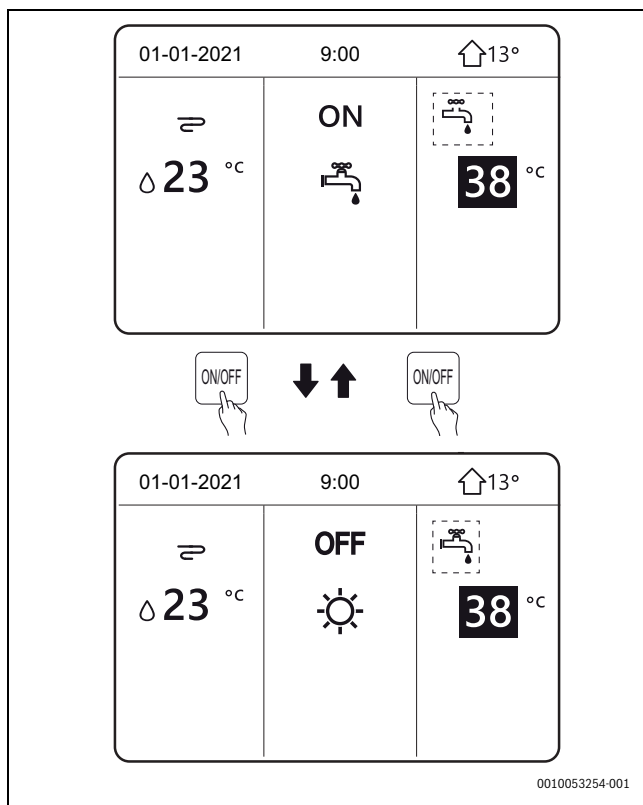





Fig. 169 DHW on/off

## 10.9 Temperature control



System water/DHW.

- ▶ Press  or  on the page.  
The black cursor will appear.

To select the temperature:

- ▶ Press the  or , when the cursor is on the temperature.

To adjust the temperature:

- ▶ Press  or , when the cursor is on the temperature.

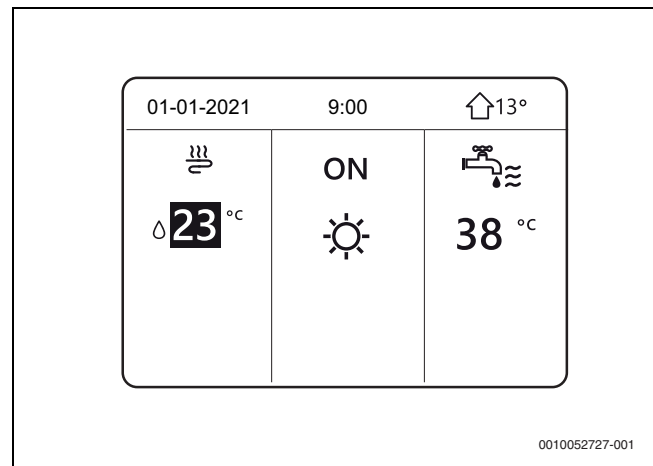

Fig. 170 Black Cursor

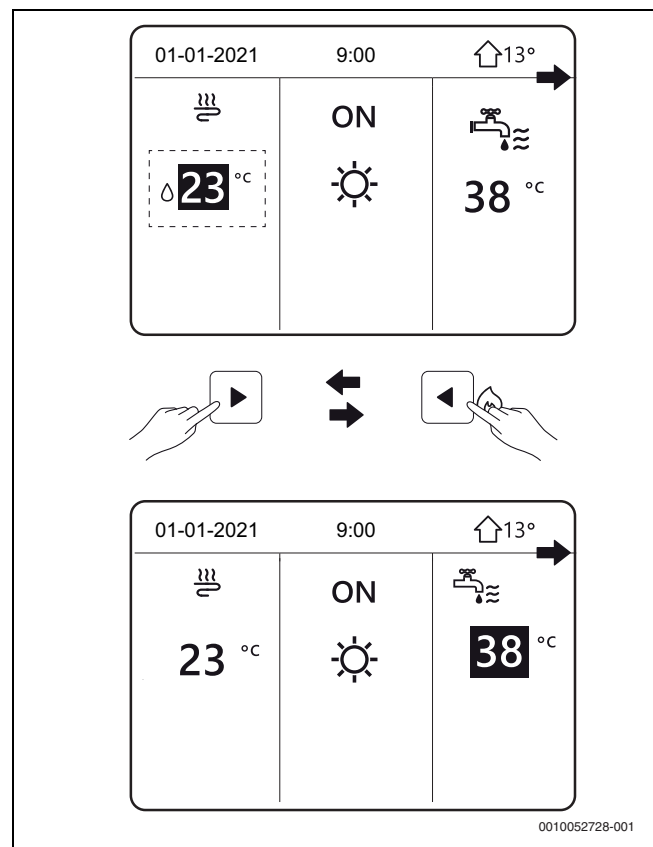

Fig. 171 Select Temperature

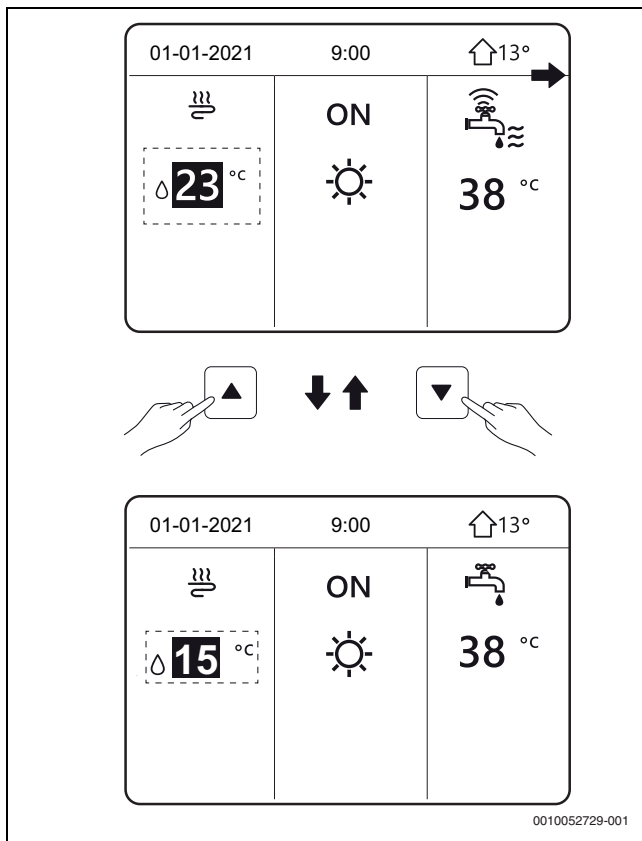

Fig. 172 Adjust temperature

**10.10 Select operation mode**

To select **OPERATION MODE** on the interface.

▶ Go to: **MENU > OPERATION MODE**.

▶ Press **OK**.

Three modes are available:

- **HEAT** for heating
- **COOL** for cooling
- **AUTO** for automatic control

To scroll:

▶ Press

To select:

▶ Press **OK**.

When the cursor is moved to an operation mode and the page is exited with , that mode is activated even if **OK** has not been pressed.

Mode	Operation mode
	Heating Mode
	Cooling Mode
	The software automatically changes the mode according to the outdoor temperature, indoor temperature and depending on the installation settings (taking into account the monthly limitations). <sup>1)</sup>

1) Automatic change is only possible under certain conditions (→ **FOR SERVICEMAN > AUTO MODE SETTING**).

Table 42 Operation mode

To control the operation mode with the room thermostat:

▶ See **FOR SERVICEMAN > ROOM THERMOSTAT**.

▶ Select **MENU > OPERATION MODE**.

▶ Press any selection or control button.

If **ROOM THERMOSTAT = MODE SETTING** is selected, the following page will be displayed.

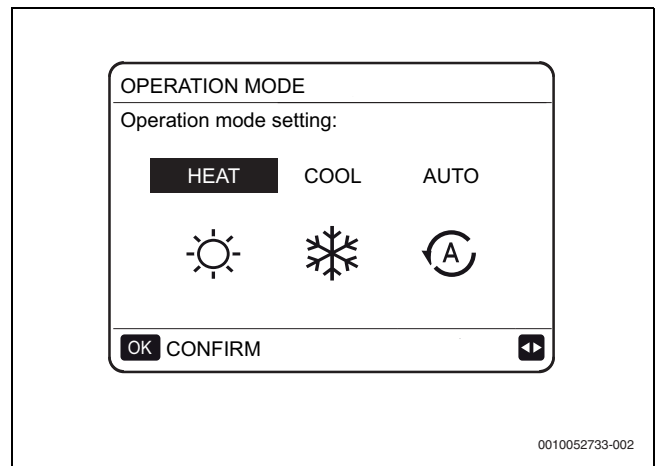

Fig. 173 Operation mode setting

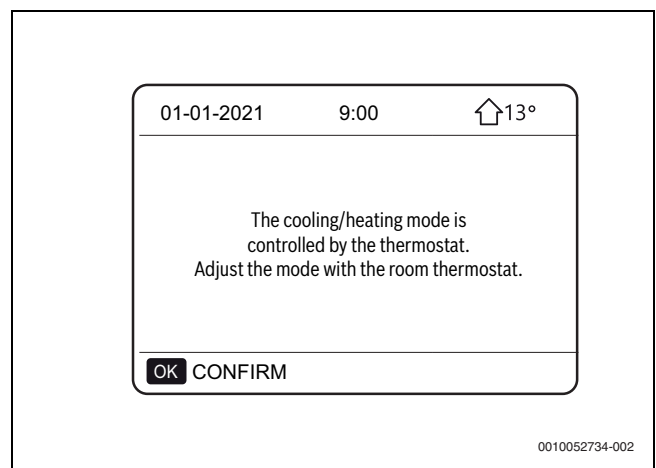

Fig. 174 Auto mode

**10.11 DEFAULT TEMPERATURES**

**DEFAULT TEMPERATURES** has 3 modes for setting the temperature:

- **DEFAULT TEMP.**
- **CLIMATE TEMP. SET.**
- **ECO MODE**

**Default temperatures**

The **DEFAULT TEMP.** function is used to set temperatures for heating or cooling mode in different time slots.

The **DEFAULT TEMP.** function does not work under the following conditions:

- When **AUTO** mode is on.
- When the **TIMER** or **WEEKLY SCHEDULE** function is on.

▶ Select **MENU > DEFAULT TEMPERATURES > DEFAULT TEMP.**

► Press **OK**.

DEFAULT TEMPERATURES 1/4

DEFAULT TEMP.	CLIMATE TEMP. SET.	ECO MODE
NO.	TIME	TEMP.
1	<input type="checkbox"/> 00:00	25° C
2	<input type="checkbox"/> 00:00	25° C
3	<input type="checkbox"/> 00:00	25° C

DEFAULT TEMPERATURES 2/4

DEFAULT TEMP.	CLIMATE TEMP. SET.	ECO MODE
NO.	TIME	TEMP.
4	<input type="checkbox"/> 00:00	25° C
5	<input type="checkbox"/> 00:00	25° C
6	<input type="checkbox"/> 00:00	25° C

0010052736-002

Fig. 175 DEFAULT TEMP.



When the DOUBLE ZONE function is on, the **DEFAULT TEMP.** function only works for zone 1.

- Use and to scroll.
  - Press to adjust the time and temperature.
  - Scroll to .
  - Press **OK** to select or deselect.
    - timer selected
    - timer deselected
- 6 time slots and 6 temperatures can be set.

If you want to delete the time slot:

- Move the cursor to  and press **OK**
- changes to . Timer 1 is deselected.

DEFAULT TEMPERATURES 4/4

DEFAULT TEMP.	CLIMATE TEMP. SET.	ECO MODE
NO.	TIME	TEMP.
1	<input checked="" type="checkbox"/> 00:00	35° C
2	<input checked="" type="checkbox"/> 00:00	25° C
3	<input checked="" type="checkbox"/> 00:00	35° C

OK  CANCEL

0010052737-002

Fig. 176 DEFAULT TEMP. - Selecting time slots

### Example

01-01-2021 9:00 13°

9:00 **ON**

35° C

0010052738-001

Fig. 177 DEFAULT TEMP. - Example

It is now 9:00 a.m. and the temperature is 35 °C.

NO.	TIME	TEMP.
1	8:00	35° C
2	9:00	25° C
3	12:00	35° C
4	18:00	25° C
5	20:00	35° C
6	23:00	25° C

Table 43 DEFAULT TEMP. schedule - Example

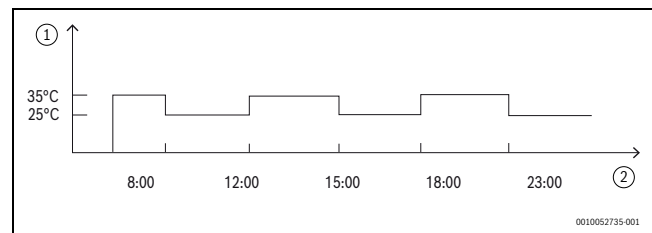

Fig. 178 DEFAULT TEMP. schedule - Example

- [1] Temperature  
[2] Time



When the room operation mode is changed, **DEFAULT TEMP.** is automatically switched off and the schedule must be set again. The **DEFAULT TEMP.** function can be used in Heating or Cooling mode.

### 10.12 CLIMATE TEMP. SET. (Climate temperature setting)

The **CLIMATE TEMP. SET.** function is used to automatically set the water temperature of the system according to the outdoor temperature. As the outdoor temperature increases, the demand for room heating is reduced.

To save energy, the desired water supply temperature is reduced when the outdoor air temperature increases in heating mode.

- Select **MENU** > **DEFAULT TEMPERATURES** > **CLIMATE TEMP. SET.**

► Press **OK**.

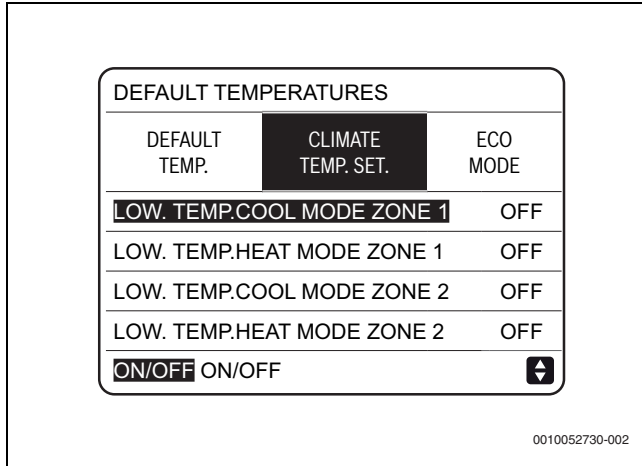

Fig. 179 CLIMATE TEMP. SET.



**CLIMATE TEMP. SET.** is used to select the climate curves for the various zones and different operation modes. The possible selections depend on the options set in **MENU > FOR SERVICEMAN > COOL MODE SETTING** and **> HEAT MODE SETTING**.

If temperature curves are selected, the desired temperature cannot be adjusted.

► Select **ON**.  
The following page appears.

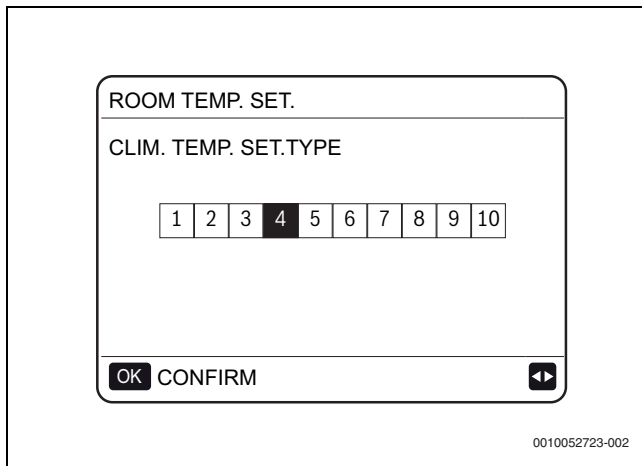

Fig. 180 Selecting climate curves

► Use to scroll.

► Press **OK** to confirm.

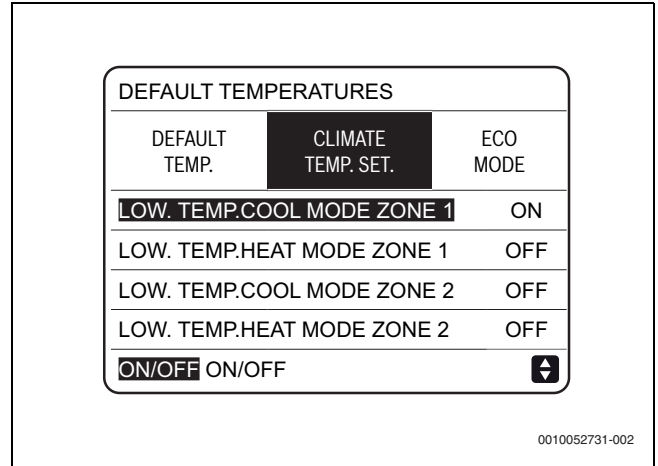

Fig. 181 CLIMATE TEMP. SET. is on

If **CLIMATE TEMP. SET.** is on, the temperature cannot be adjusted:

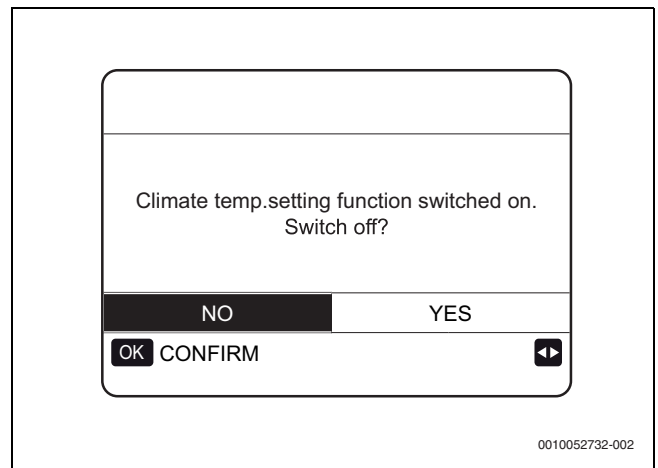

Fig. 182 CLIMATE TEMP. SET. - Error message

- Select **NO**.
- Press **OK** to return to the home page.
- Select **YES**.
- Press **OK** to switch off the **CLIMATE TEMP. SET.** function.

### 10.13 ECO MODE

**ECO MODE** is used to save energy.

The **ECO MODE** function is activated if **DOUBLE ZONE** is on **NO**, if **DOUBLE ZONE** is on **YES**, the **ECO MODE** function is not activated (→ **MENU > FOR SERVICEMAN > 5. TEMP. TYPE SETTING**).



When the function is on, appears on the keypad.

- Select **MENU > DEFAULT TEMPERATURES > ECO MODE**.

- ▶ Press **OK**.  
The following page appears.

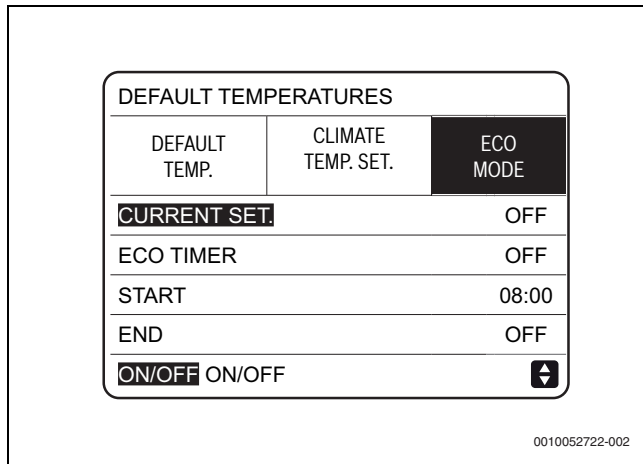

Fig. 183 ECO MODE

- ▶ Press **ON/OFF**.  
The following page appears.

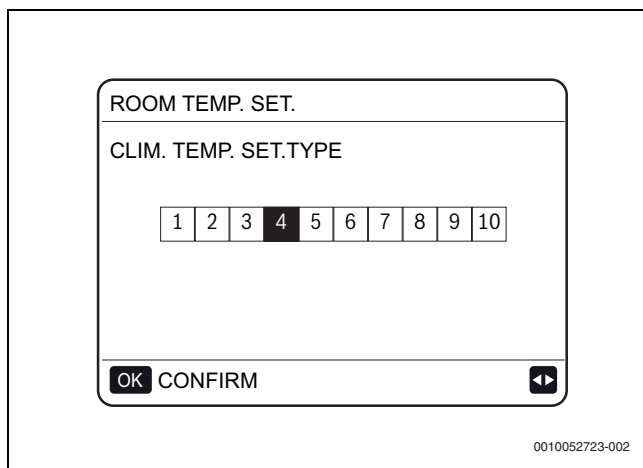

Fig. 184 Selecting climate curves

- ▶ Use to scroll.
- ▶ Press **OK** to confirm.
- ▶ Press **ON/OFF** to select **ON/OFF**.
- ▶ Use to scroll.

When the cursor is on **START** or **END**:

- ▶ Use and to scroll

- ▶ Use to adjust the time.

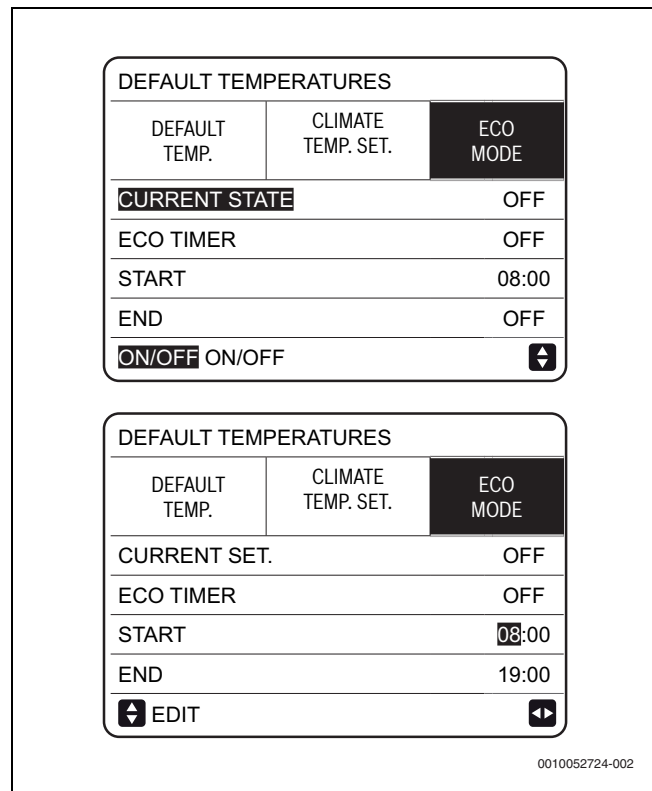

Fig. 185 ECO MODE - Adjusting the time

- If **ECO MODE** is set to **ON**, the desired temperature (T1S) cannot be adjusted.
- If **ECO MODE** is **ON** and **ECO TIMER** is **OFF**, the unit always operates in **ECO MODE**.
- If **ECO MODE** is **ON** and **ECO TIMER** is **ON**, the unit operates in **ECO MODE** according to the start and end time.

## 10.14 Domestic hot water (DHW)

DHW mode for domestic hot water production includes the following functions:

- **DISINFECT** (anti-legionella)
- **FAST DHW**
- **TANK HEAT**
- **DHW PUMP** (DHW recirculation)

### 10.14.1 DISINFECT (anti-legionella)

The **DISINFECT** function is used to eliminate legionella bacteria by raising the storage tank temperature to 65-70 °C).

The disinfect temperature is set in **DHW MODE** (→ **FOR SERVICEMAN** > **DHW MODE** > **DISINFECT**).

- ▶ Select **MENU** > **DOMESTIC HOT WATER(DHW)** > **DISINFECT**.

► Press **OK**.

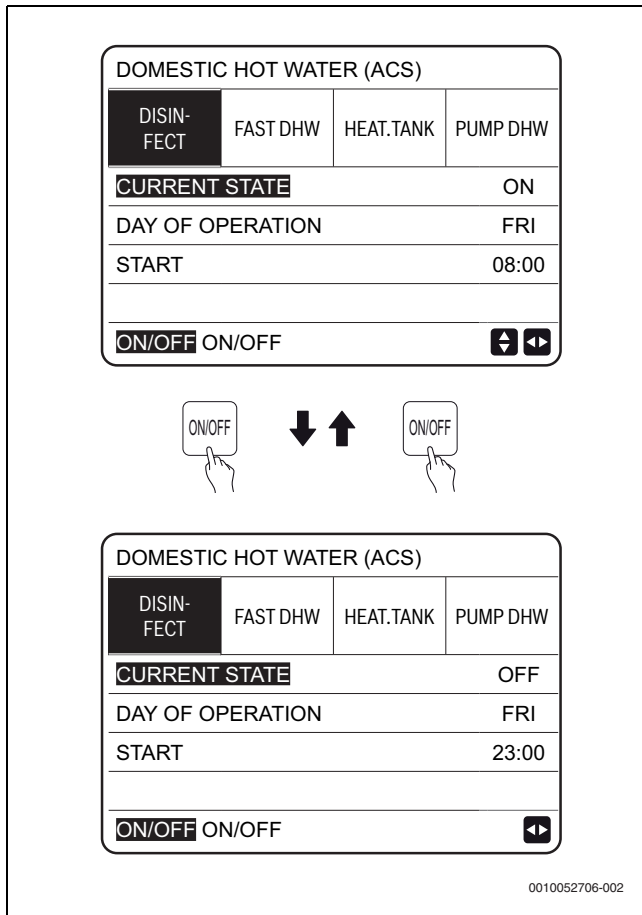

Fig. 186 DISINFECT

- Use and to scroll.
- Press to adjust the **DAY OF OPERATION** and **START** parameters.

**Example:**

The **DAY OF OPERATION** is set to Friday and the start time is set to 23:00, the **DISINFECT** function will start at 23:00 on Friday.

If the **DISINFECT** function is on, the following page appears. In **DISINFECT** operation the unit does not work towards the system.

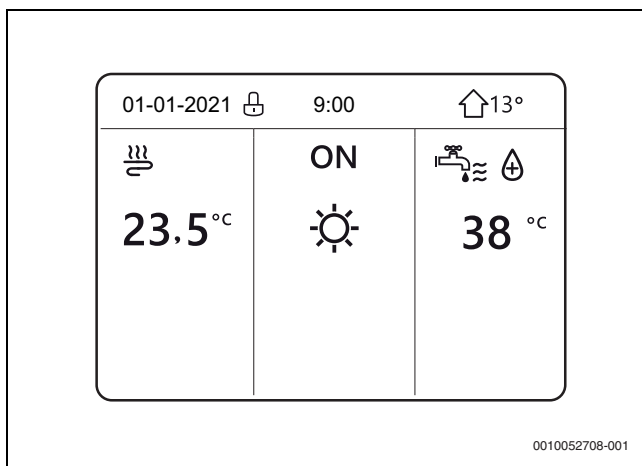

Fig. 187 DISINFECT function is on

**10.14.2 FAST DHW**

The **FAST DHW** function is used to force **DHW MODE** for domestic hot water production.

The heat pump will be switched on together with the storage tank heater and the domestic hot water temperature will be brought to setpoint.

- Select **MENU > DOMESTIC HOT WATER(DHW) > FAST DHW**.
- Press **OK**.
- Press **ON/OFF** to select **ON** or **OFF**.



The **FAST DHW** function is only run once each time it is switched on.

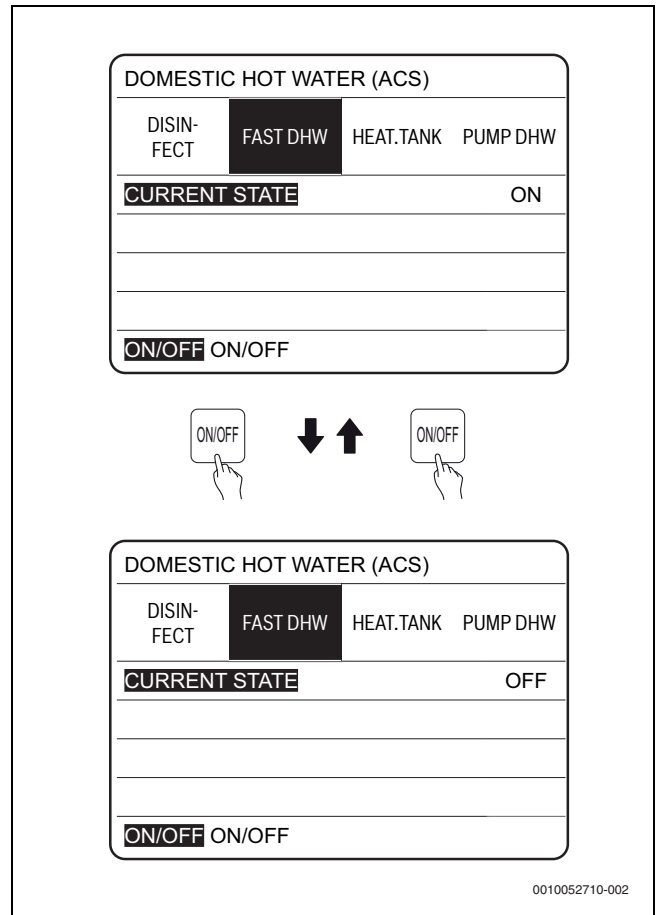

Fig. 188 FAST DHW

**10.14.3 TANK HEAT**

The **TANK HEAT** function is used to force the water to heat up in the storage tank (using the storage tank heater) in cases where the heat pump is on for heating or cooling functions but there is still a demand for domestic hot water.

The **TANK HEAT** function can be used to heat the water in the storage tank even if the heat pump has failed.

- Select **MENU > DOMESTIC HOT WATER(DHW) > TANK HEAT**.
- Press **OK**.

- ▶ Press **ON/OFF** to select **ON** or **OFF**.

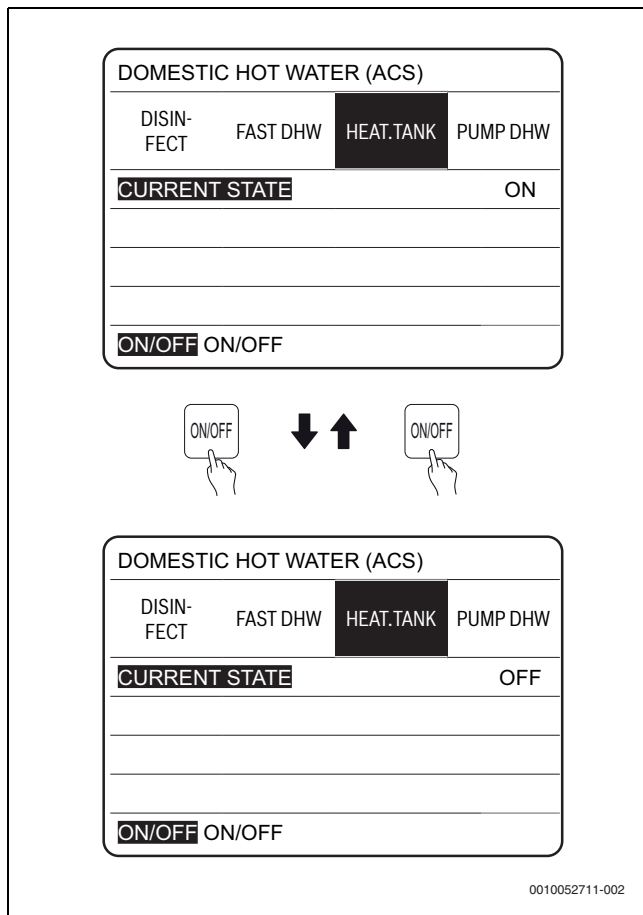

Fig. 189 TANK HEAT

- ▶ Use to exit.

If the **TANK HEAT** function is on, the following page appears.

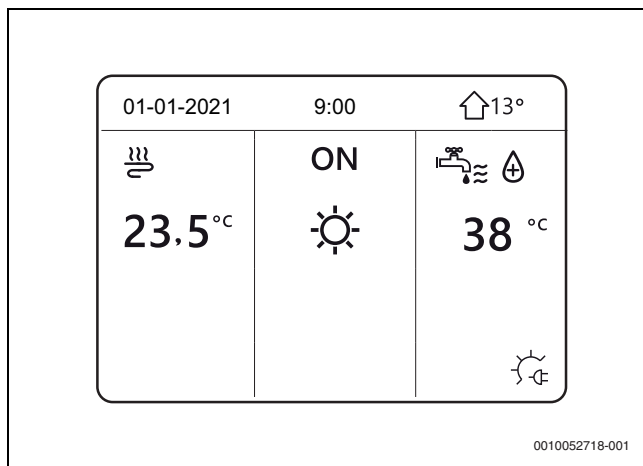

Fig. 190 TANK HEAT function is on



If **CURRENT STATE** is **OFF**, the **TANK HEAT** function is disabled. If the storage tank sensor T5 is faulty, the heater will not start.

#### 10.14.4 DHW PUMP (recirculation) if present

The **DHW PUMP** function recirculates the water in the water system.

To enable the function:

- ▶ Select **MENU > FOR SERVICEMAN > 1. DHW MODE SETTING**.

- ▶ Enable the parameters:
  - **1.4 PUMP\_D**
  - **1.19 PUMP\_D TIMER**



The pump is to be provided by the customer.

- ▶ Select **MENU > DOMESTIC HOT WATER(DHW) > DHW PUMP**.
- ▶ Press **OK**.

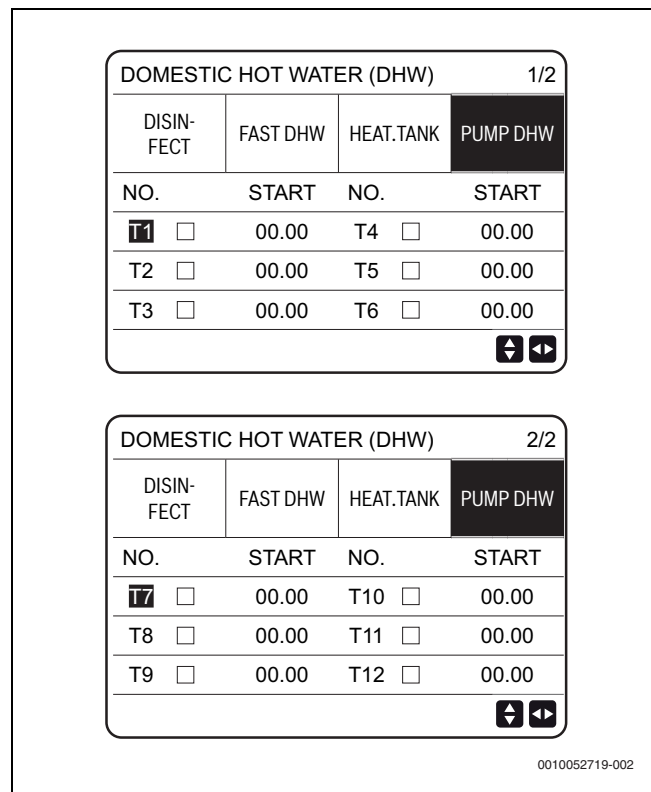

Fig. 191 DHW PUMP

- ▶ Use and to scroll.
- ▶ Use to adjust the parameters.
- ▶ Scroll to .
- ▶ Press **OK** to select or deselect.
  - timer selected
  - timer deselected

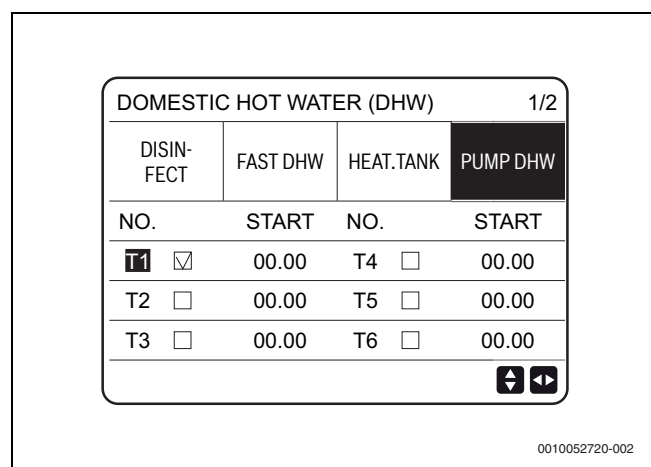

Fig. 192 DHW PUMP - T1 selected

**Example:**

The **DHW PUMP** parameter has been set (→ **FOR SERVICEMAN > 1. DHW MODE SETTING**). The operating time of the **PUMP** is adjustable with the parameters.

NO.	TIME
1	6:00
2	7:00
3	8:00
4	9:00

Table 44 Schedule example

Parameter **1.19 PUMP\_D TIMER** has been set at 30 minutes, the pump will start at the following times:

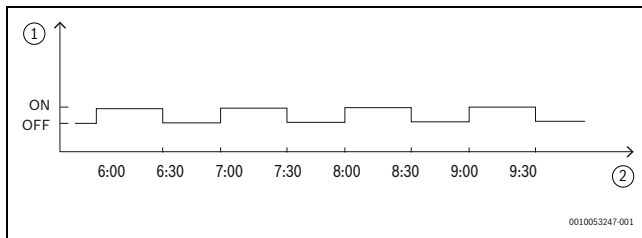

Fig. 193 Pump starting times

- [1] Pump
- [2] Time

**10.15 Time schedule**

The menu includes the following functions:

- **TIMER** for daily schedule
- **WEEKLY SCHEDULE** for weekly schedule
- **SCHEDULE CHECK** to check the schedule
- **CANCEL TIMER** to delete the schedule

**10.15.1 TIMER**

If the **WEEKLY SCHEDULE** is **ON** and the **TIMER** function is **OFF**, the setting that is on takes precedence.



If the **TIMER** function is **ON**, appears on the home page.

- ▶ Use and to scroll.
  - ▶ Press to adjust the time, mode and temperature.
  - ▶ Scroll to .
  - ▶ Press **OK** to select or deselect.
    - timer selected
    - timer deselected
- 6 time slots can be set.

If you want to delete the **TIMER**:

- ▶ Move the cursor to  and press **OK**  
 changes to . The timer switches off.

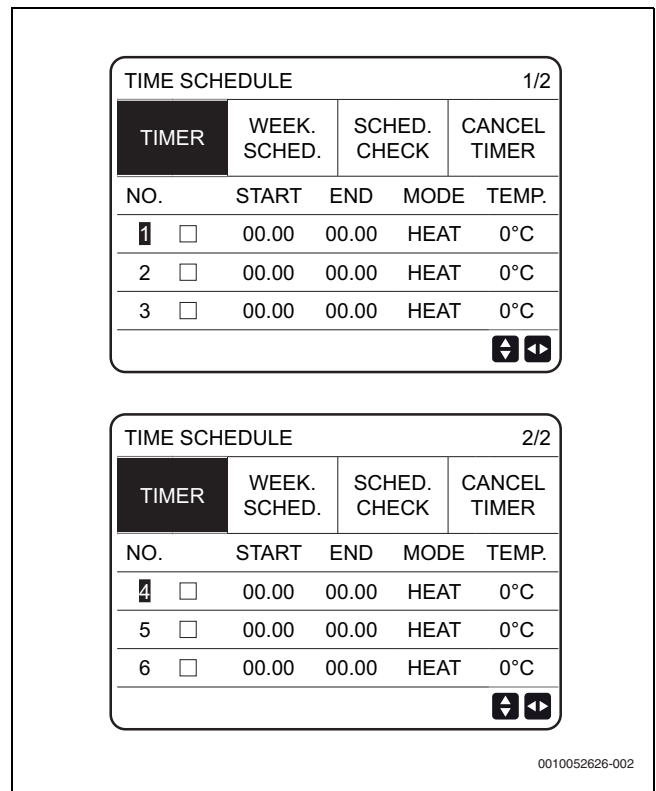

Fig. 194 TIMER

If a start time is set later than the end time, or a temperature outside the allowed range is set for the chosen operation mode, the following page appears.

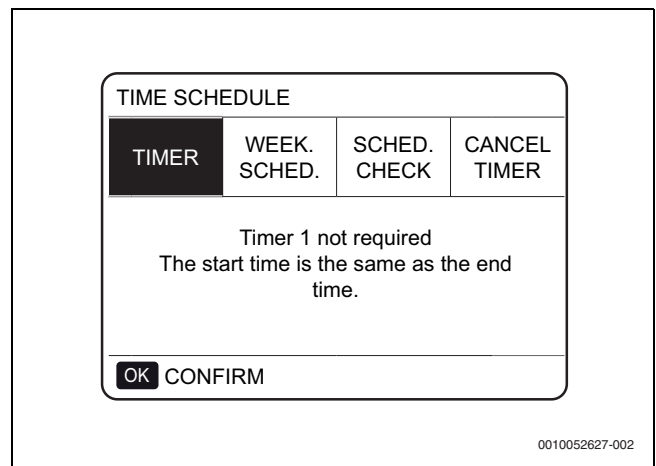

Fig. 195 TIMER error message

**Example**

Setting 6 time slots:

NO.	START	END	MODE	TEMP.
T1	1:00	3:00	DHW	50 °C
T2	7:00	9:00	HEAT	28 °C
T3	11:30	13:30	COOL	20 °C
T4	14:30	16:30	HEAT	28 °C
T5	15:00	19:00	COOL	20 °C
T6	18:00	23:30	DHW	50 °C

Table 45 Example time slots

The unit is switched on as follows:

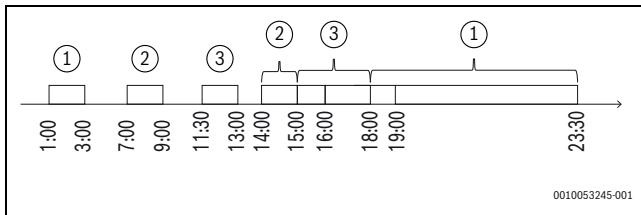

Fig. 196 TIMER example

- [1] DHW
- [2] Heat
- [3] Cool

Operation of the control unit according to the schedule:

TIME	Control unit operation
1:00	<b>DHW</b> mode is switched <b>ON</b>
3:00	<b>DHW</b> mode is switched <b>OFF</b>
7:00	<b>HEAT</b> mode is switched <b>ON</b>
9:00	<b>HEAT</b> mode is switched <b>OFF</b>
11:30	<b>COOL</b> mode is switched <b>ON</b>
13:00	<b>COOL</b> mode is switched <b>OFF</b>
14:00	<b>HEAT</b> mode is switched <b>ON</b>
15:00	<b>COOL</b> mode is switched <b>ON</b> and <b>HEAT</b> mode is switched <b>OFF</b>
16:00	<b>HEAT</b> mode is switched <b>OFF</b>
18:00	<b>DHW</b> mode is switched <b>ON</b>
19:00	<b>COOL</b> mode is switched <b>OFF</b>
23:00	<b>DHW</b> mode is switched <b>OFF</b>

Table 46 Operation of the control unit



If the start time and the end time are the same in the same time schedule, the **TIMER** function is not valid.

### 10.15.2 WEEKLY SCHEDULE

If the **TIMER** is **ON** and the **WEEKLY SCHEDULE** is **OFF**, the most recent setting is valid.



If the **WEEKLY SCHEDULE** function is **ON**, **7** appears on the home page.

- ▶ Select **MENU > SCHEDULE > WEEKLY SCHEDULE**.
- ▶ Press **OK**.

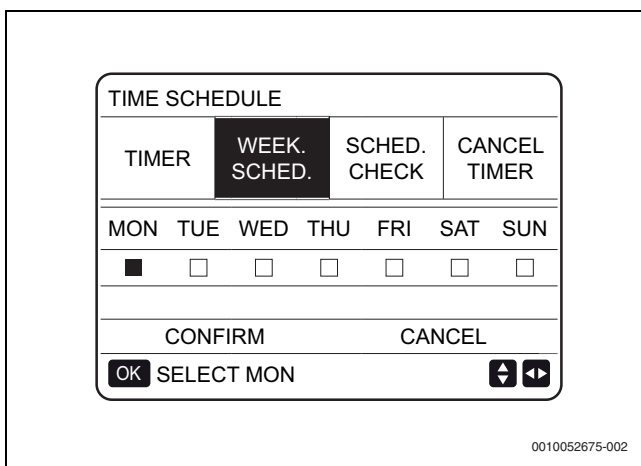

Fig. 197 WEEKLY SCHEDULE

- ▶ Select the days of the week you wish to schedule.

- ▶ Press to scroll through the days.
- ▶ Press **OK** to select or deselect the day.  
If the day appears as **MON**, it means that it is selected. If it appears as **MON.**, it means that it is deselected.



To enable the **WEEKLY SCHEDULE** function, at least two days must be scheduled.

- ▶ Press to select the days.
- ▶ Press **OK** to select or deselect the day.  
Example:  
The days from Monday to Friday are selected and have the same schedule.

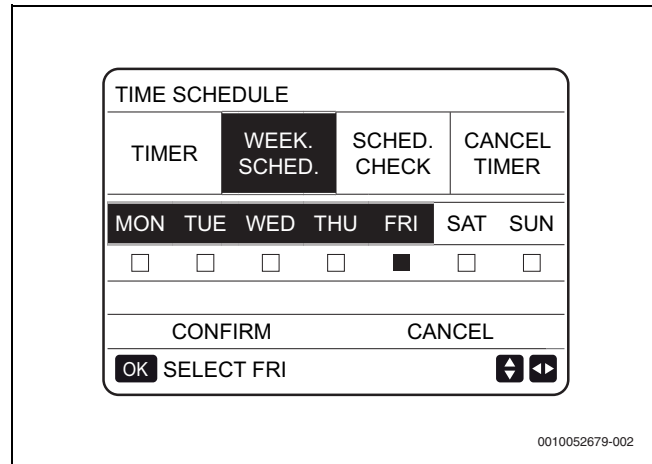

Fig. 198 WEEKLY SCHEDULE - Example

- ▶ Keep pressing to **CONFIRM**.

► Press **OK**.

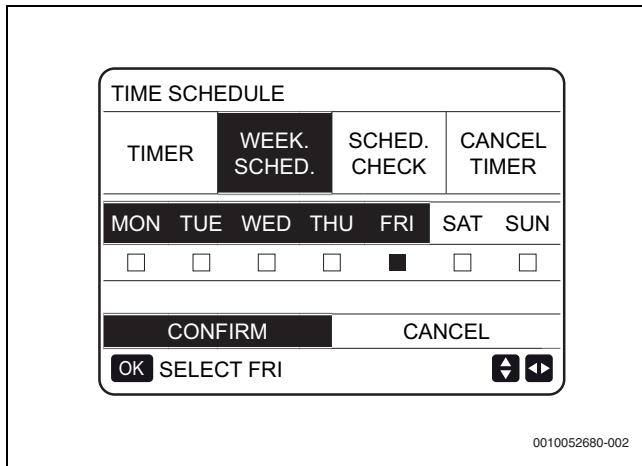

Fig. 199 WEEKLY SCHEDULE - Confirmation

The following pages appear.

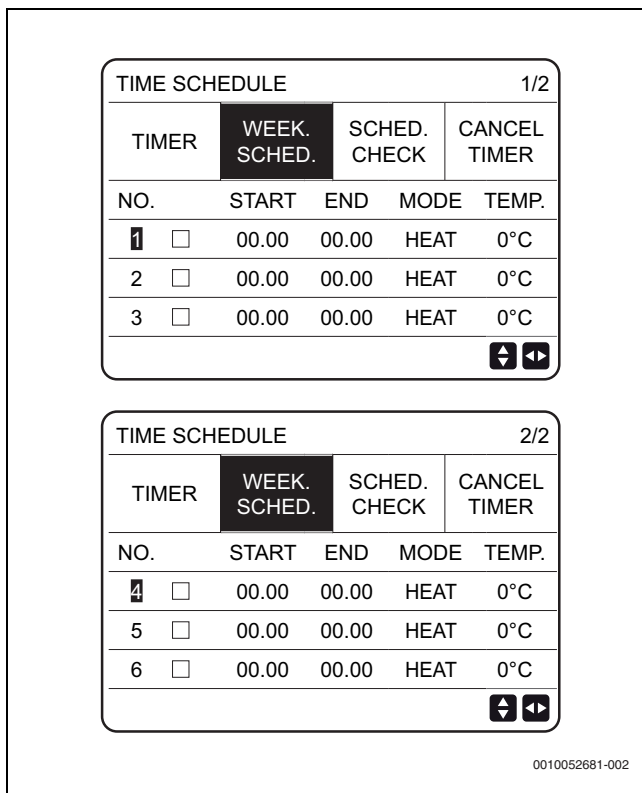

Fig. 200 WEEKLY SCHEDULE - Settings

- Use and to scroll and adjust the time, mode and temperature.
  - Start and stop times, operation mode and temperature can be set.
  - The modes available are Heat mode, Cool mode and DHW mode.
- To set the schedule, refer to the daily timer schedule.



The end time must be later than the start time, otherwise the timer schedule will have no effect; the **Timer not needed, cannot be activated** indication will appear.

**10.15.3 SCHEDULE CHECK**

The **SCHEDULE CHECK** can only check the weekly schedule.

- Select **MENU > SCHEDULE > SCHEDULE CHECK**.

► Press **OK**.

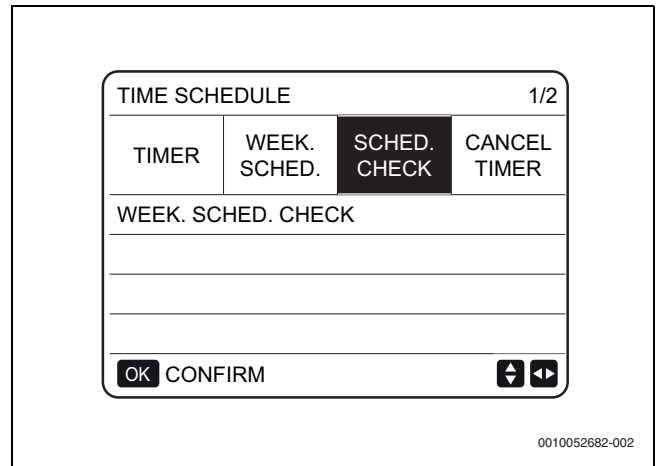

Fig. 201 SCHEDULE CHECK

- Press to display the schedule from Monday to Sunday.

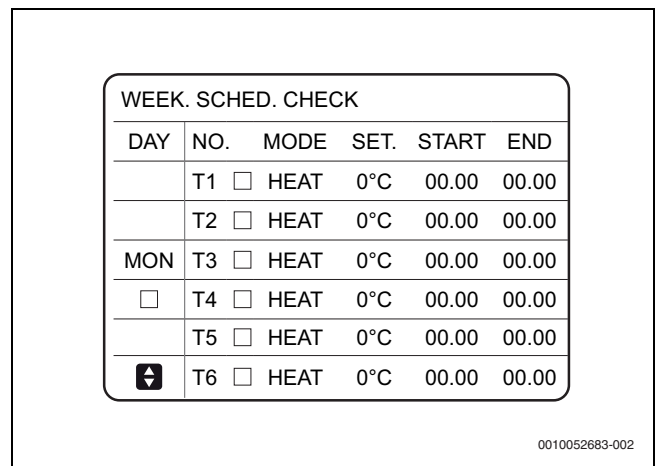

Fig. 202 WEEKLY SCHEDULE CHECK

**10.15.4 CANCEL TIMER**

- Select **MENU > SCHEDULE > CANCEL TIMER**.
- Press **OK**.

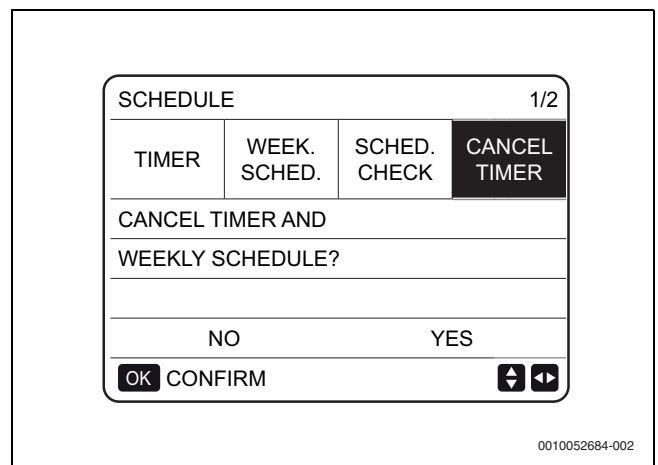
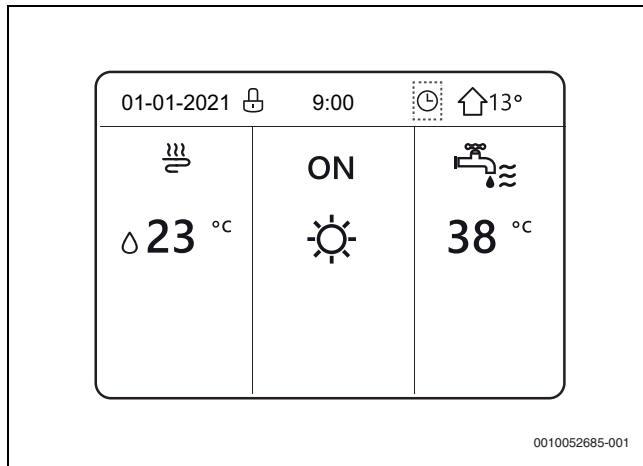

Fig. 203 CANCEL TIMER

- Use and to scroll to **YES**.
- Press **OK** to delete the schedule.
- Press **BACK** to exit **CANCEL TIMER**.

If **TIMER** or **WEEKLY SCHEDULE** is on, the **TIMER** icon (🕒) or the **WEEKLY SCHEDULE** icon (7) will be displayed on the home page.

Fig. 204 **TIMER** is on

If the **TIMER** or **WEEKLY SCHEDULE** is cancelled, the icon will disappear from the home page.

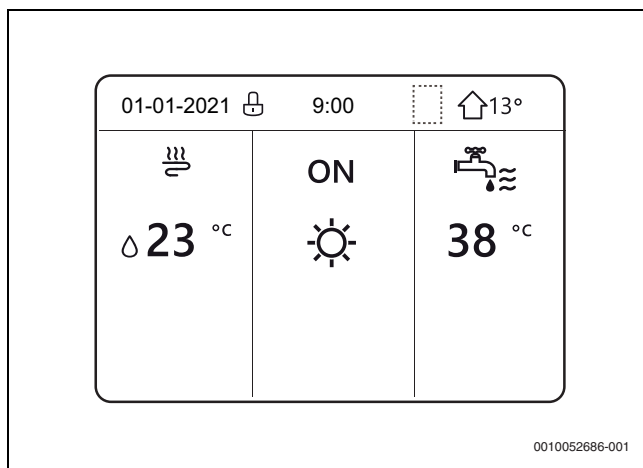
Fig. 205 **TIMER** or **WEEKLY SCHEDULE** is cancelled

The **TIMER/WEEKLY SCHEDULE** must be reset if switching from **WATER FLOW TEMP.** to **ROOM TEMP.** or from **ROOM TEMP.** to **WATER FLOW TEMP.**. Neither the **TIMER** or **WEEKLY SCHEDULE** are valid if the **ROOM THERMOSTAT** is on.

- The **ECO MODE** function has the highest priority, followed in sequence by the **TIMER** or **WEEKLY SCHEDULE** functions and the **DEFAULT TEMPERATURES** or **CLIMATE TEMP. SET.** functions.
- If **ECO MODE** is on, the **DEFAULT TEMPERATURES** or **CLIMATE TEMP. SET.** functions are disabled.
- If **ECO MODE** is off, the **DEFAULT TEMPERATURES** or **CLIMATE TEMP. SET.** functions must be set again.
- The **TIMER** or **WEEKLY SCHEDULE** functions are disabled when the unit operates in **ECO MODE**.
- The **TIMER** or **WEEKLY SCHEDULE** functions can only operate if **ECO MODE** is off.
- The **TIMER** and **WEEKLY SCHEDULE** functions have the same priority and the function that is set last takes precedence.
- The **DEFAULT TEMPERATURES** function is switched off if the **TIMER** or **WEEKLY SCHEDULE** functions are switched on.
- The **CLIMATE TEMP. SET.** function is not affected when the **TIMER** or **WEEKLY SCHEDULE** functions are set.
- The **DEFAULT TEMPERATURES** and **CLIMATE TEMP. SET.** functions have the same priority and the function that is set last takes precedence.



For all functions with an hourly schedule (**DEFAULT TEMPERATURES**, **ECO**, **DISINFECT**, **DHW PUMP**, **TIMER**, **WEEKLY SCHEDULE**, **SILENT MODE**, **HOLIDAY AT HOME**), they can only be switched **ON/OFF** at the start and end times set.

### 10.16 Options

The **OPTIONS** menu includes the following functions:

- **SILENT MODE**
- **HOLIDAY AWAY**
- **HOLIDAY AT HOME**
- **BACKUP HEATING**

#### 10.16.1 SILENT MODE

**SILENT MODE** enables quieter operation of the unit. However, it also reduces the heating/cooling capacity of the system.

There are 2 **SILENT MODE** levels. Level 2 is quieter than level 1, and further reduces the heating or cooling capacity.

**SILENT MODE** can be used in the following modes:

- continuous operation
- start-up with timer



If the Silent Mode is on,  appears on the home page.

- ▶ Select **MENU > OPTIONS > SILENT MODE**.
- ▶ Press **OK**.
- ▶ Press **ON/OFF** to set **CURRENT STATE** to **ON** or **OFF**.

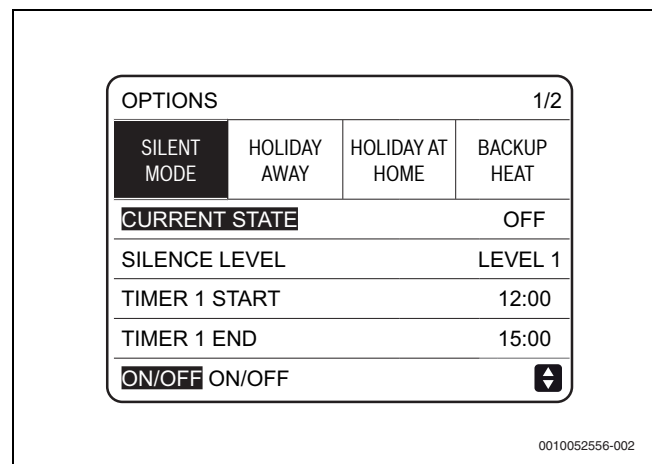
Fig. 206 **CURRENT STATE**

If **CURRENT STATE** is **OFF**, **SILENT MODE** is disabled.

- ▶ Select **SILENCE LEVEL**.

- ▶ Press **OK**.  
The following page appears.

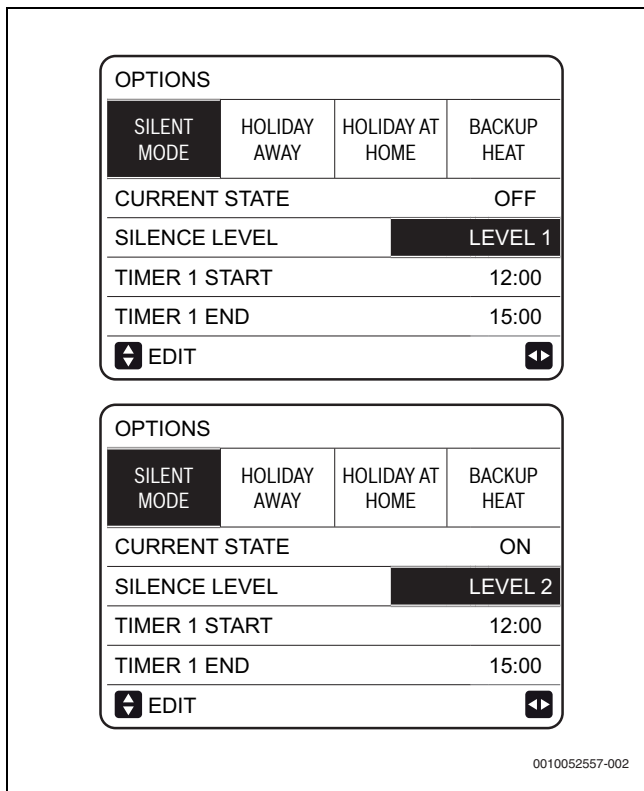

Fig. 207 SILENCE LEVEL

- ▶ Press **↕** to select **LEVEL 1** or **LEVEL 2**.
- ▶ Press **OK**.
- ▶ Select **TIMER**.
- ▶ Press **OK**.  
2 time slots can be set.

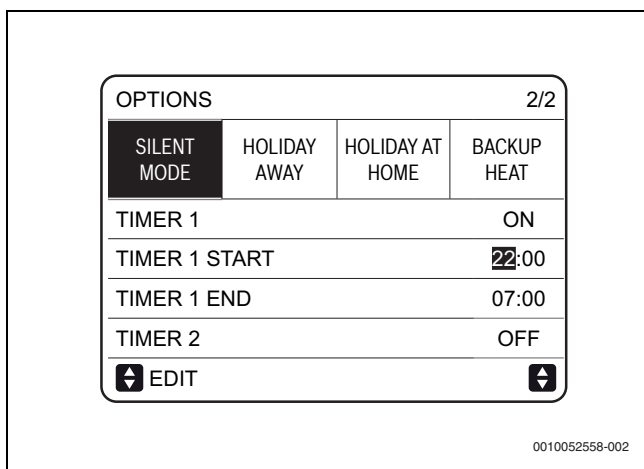



Fig. 208 TIMER settings

- ▶ Press **↕** to select **ON** or **OFF**.
- ▶ Press **OK** to select or deselect.

**i**  
If the two time slots are both deselected, **SILENT MODE** is always operational. Otherwise, it will be switched on according to the time schedule.

**10.16.2 HOLIDAY AWAY**

This function prevents the system from freezing during winter holidays away from home and restarts the unit before returning home, while at the same time limiting consumption of the unit when not in use.

**i**  
If the **HOLIDAY AWAY** function is on,  appears on the home page.

- ▶ Select **MENU > OPTIONS > HOLIDAY AWAY**.
- ▶ Press **OK**.
- ▶ Press **ON/OFF** to select **ON** or **OFF**.

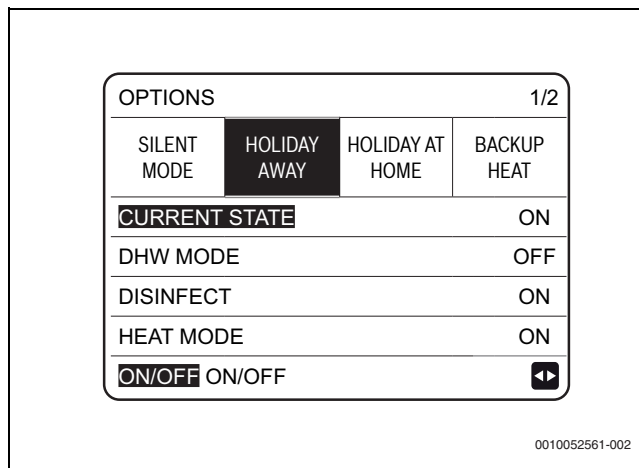

Fig. 209 HOLIDAY AWAY - Menu page 1/2

- ▶ Use **↔** and **↕** to scroll and adjust the values.

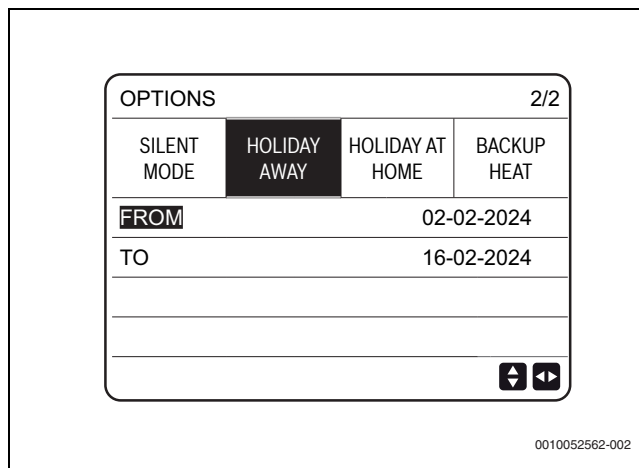

Fig. 210 HOLIDAY AWAY - Menu page 2/2

**Example:**

Suppose you want to go on a winter holiday. The current date is 31/01/2024 and you will leave on 02/02/2024, two days later.

- You will leave in 2 days and the house will be empty for 2 weeks.
- You want to reduce energy consumption and at the same time prevent your house from freezing.

Proceed as follows:

- ▶ Select **MENU > OPTIONS > HOLIDAY AWAY**.
- ▶ Press **OK**.
- ▶ Press **ON/OFF** to select **ON**.
- ▶ Use **↔** and **↕** to scroll and adjust the values as shown below.

Setting	Value
HOLIDAY AWAY	ON
FROM	02-02-2024
TO	16-02-2024

Setting	Value
OPERATION MODE	HEAT
DISINFECT	ON

Table 47 Example settings

**Notes:**

- If **HOLIDAY AWAY** mode is **ON** and the **DHW** function is set to **ON**, the disinfect function cannot be switched on.
- If **HOLIDAY AWAY** mode is **ON**, the **TIMER** and **WEEKLY SCHEDULE** functions are disabled.
- If **CURRENT STATE** is **OFF**, the **HOLIDAY AWAY** mode is **OFF**.
- If **CURRENT STATE** is **ON**, the **HOLIDAY AWAY** mode is **ON**.
- The remote control does not accept instructions when **HOLIDAY AWAY** mode is **ON**.
- If the **DISINFECT** function is on, the unit will be disinfected at 23:00 on the last day.
- When **HOLIDAY AWAY** mode is on, the previously set climate curves are disabled and become operational again at the end of the scheduled period.
- The preset temperature is invalid while **HOLIDAY AWAY** mode is **ON**, but the value remains displayed on the home page.

**10.16.3 HOLIDAY AT HOME**

The **HOLIDAY AT HOME** function allows you to schedule up to 6 programmes without changing the normal schedule when spending your holidays at home.

During the holiday, the **HOLIDAY AT HOME** mode allows you to override the normal schedule without changing it.

Period	Schedule
Before and after the holiday	The normal schedule is applied.
During the holiday	The settings configured for the <b>HOLIDAY AT HOME</b> mode are used.

Table 48 HOLIDAY AT HOME



If the **HOLIDAY AT HOME** function is on,  appears on the home page.

- ▶ Select **MENU > OPTIONS > HOLIDAY AT HOME**.
- ▶ Press **OK**.  
The following page appears.

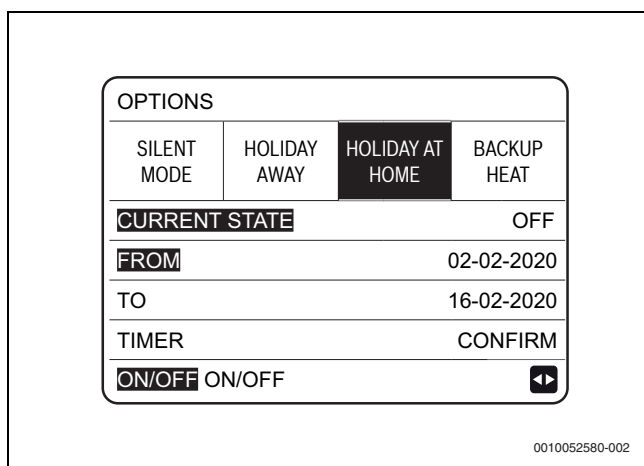



Fig. 211 HOLIDAY AT HOME

- ▶ Select **CURRENT STATE**.

- ▶ Press **ON/OFF** to select **OFF** or **ON**.
  - If **CURRENT STATE** is **OFF**, the **HOLIDAY AT HOME** function is off.
  - If **CURRENT STATE** is **ON**, the **HOLIDAY AT HOME** function is on.
- ▶ Press down to adjust the date.
- ▶ Use  and  to scroll and adjust the values.
- ▶ Select **TIMER**.
- ▶ Press **OK** twice.

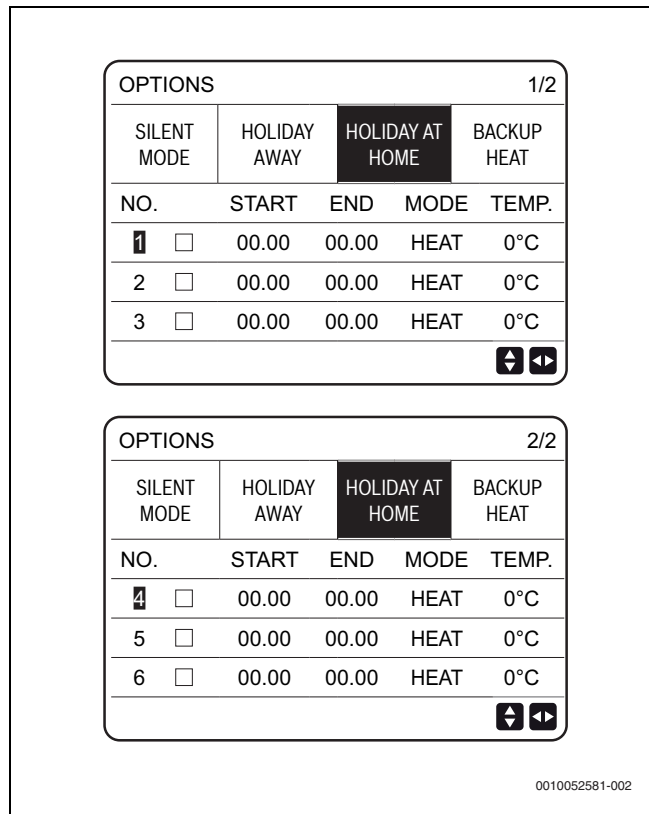





Fig. 212 TIMER settings

- ▶ Use  and  to scroll.
- ▶ Use  to adjust the time, mode and temperature.
- ▶ Scroll to .
- ▶ Press **OK** to select or deselect.
  - Prg. selected
  - Prg. deselected

If you want to delete the schedule:

- ▶ Move the cursor up and press **OK**  
 changes to . The schedule is switched off.

If a start time is set later than the end time, or a temperature outside the allowed range is set for the chosen operation mode, the following page appears.

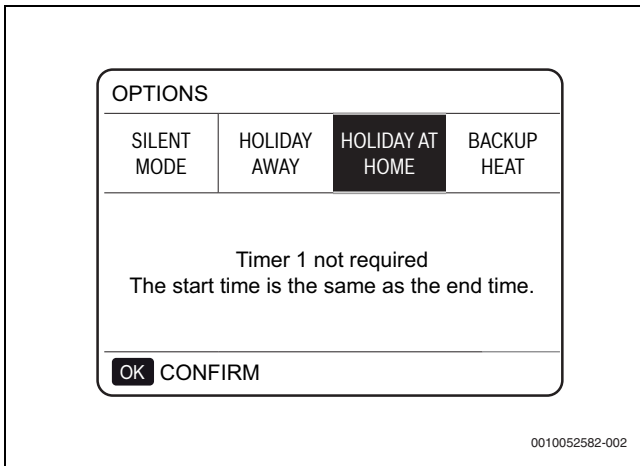

Fig. 213 HOLIDAY AT HOME error message



The **HOLIDAY AWAY** or **HOLIDAY AT HOME** functions must be set again if you change the unit's operation mode.

#### 10.16.4 BACKUP HEATER

Available as an accessory.

The **BACKUP HEATER** function is used to force the backup heater on.

- ▶ Select MENU > OPTIONS > BACKUP HEATER.
- ▶ Press OK.

If IBH (indoor unit backup heater) and AHS (additional heating source) are not enabled by the Dip-switches on the main hydraulic module control board, the following page appears.

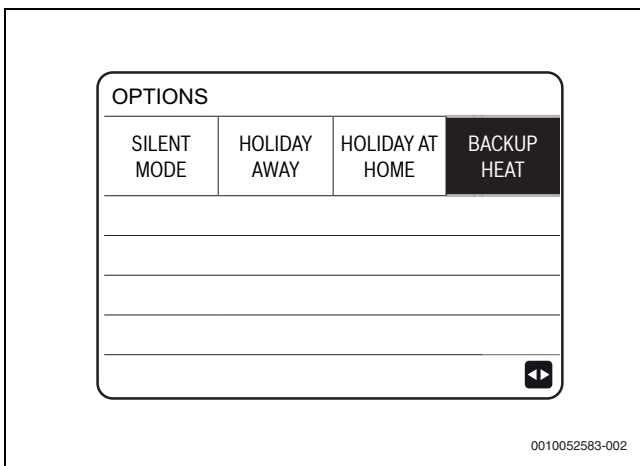

Fig. 214 BACKUP HEATER not available

If IBH and AHS are enabled by the Dip-switches on the main hydraulic module control board, the following page appears

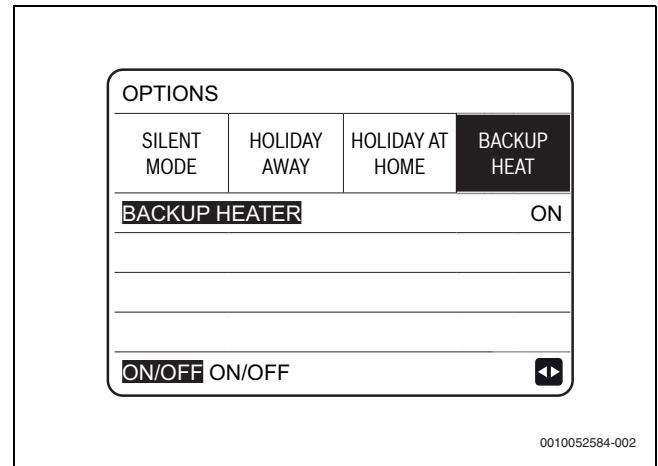

Fig. 215 BACKUP HEATER

- ▶ Use **ON/OFF** to select **ON** or **OFF**.



If **AUTO** mode is on for room heating or cooling, the **BACKUP HEATER** cannot be selected. The **BACKUP HEATER** function is invalid if only **ROOM HEATING MODE** is enabled.

#### 10.16.5 CHILD LOCK

The **CHILD LOCK** function prevents children from misusing the unit. This function locks or unlocks selection of the operation mode and temperature control.

- ▶ Select **MENU > CHILD LOCK**.
- ▶ Enter the password.

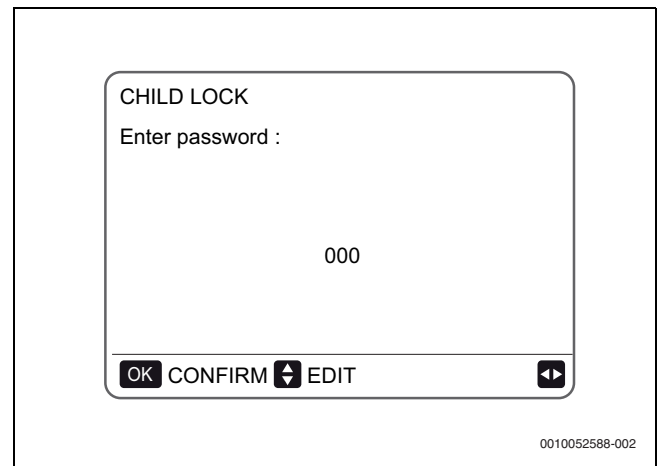

Fig. 216 Password

- ▶ Press  to scroll.

- ▶ Press **LOCK/UNLOCK** to lock or unlock one or more operation modes.

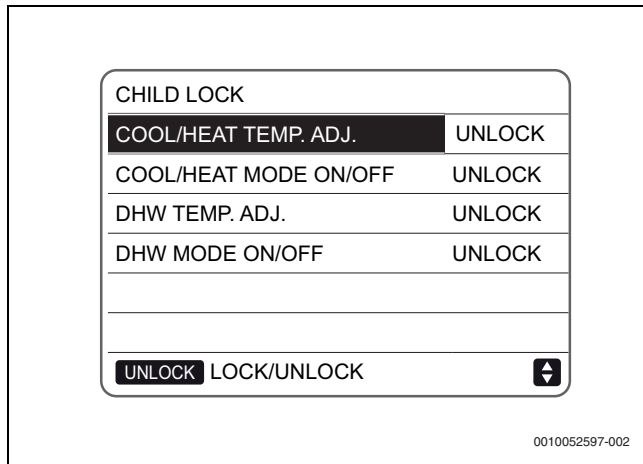

Fig. 217 CHILD LOCK



The cooling/heating temperature cannot be adjusted when **COOL/HEAT TEMP.ADJUST** is locked.

If you want to adjust the cooling/heating temperature when it is locked, the following page appears.

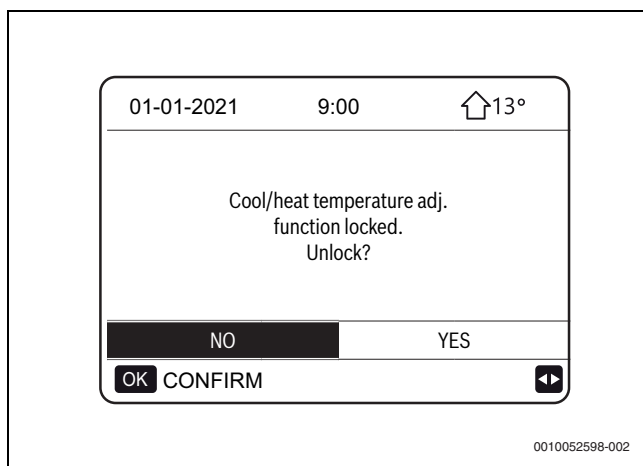

Fig. 218 Unlock COOL/HEAT TEMP.ADJUST



The cooling/heating mode cannot be switched on or off when **COOL/HEAT MODE ON/OFF** is locked.

If you want to switch **COOL/HEAT MODE ON/OFF** on or off when it is locked, the following page appears.

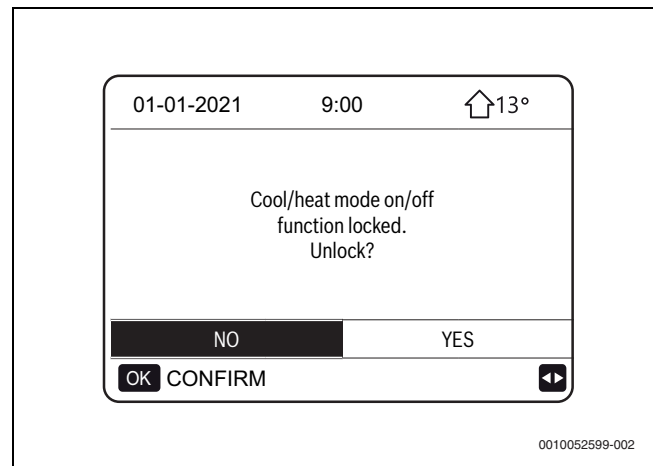

Fig. 219 Unlock COOL/HEAT MODE ON/OFF



The domestic hot water temperature cannot be adjusted when the **DHW TEMP.ADJUST** is locked.

If you want to adjust the hot water temperature when **DHW TEMP.ADJUST** is locked, the following page appears.

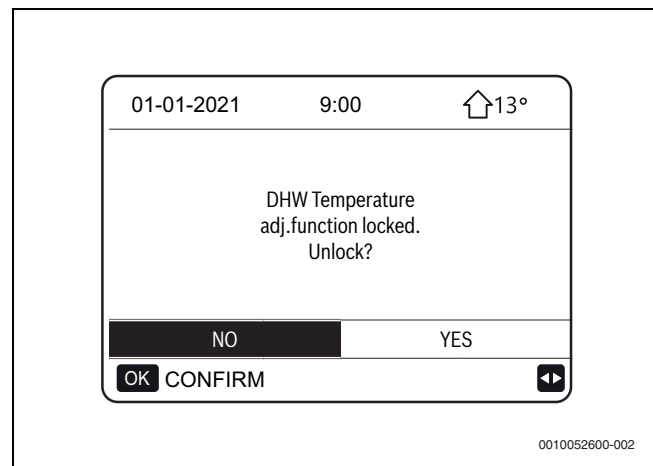

Fig. 220 Unlock DHW TEMP.ADJUST



DHW mode cannot be switched on or off when **DHW MODE ON/OFF** is locked.

If you want to switch DHW mode on or off when **DHW MODE ON/OFF** is locked, the following page appears.

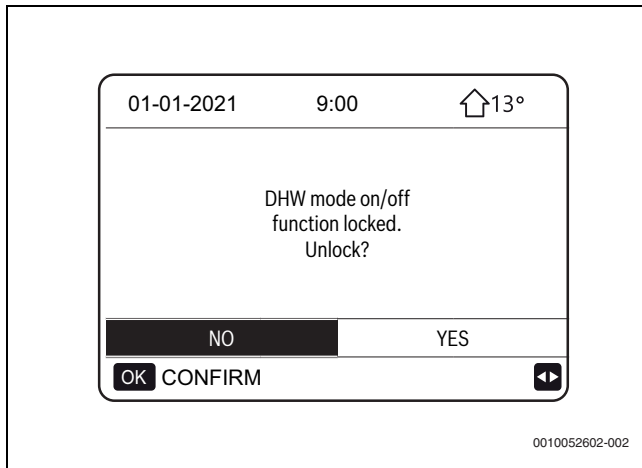

Fig. 221 Unlock DHW MODE ON/OFF

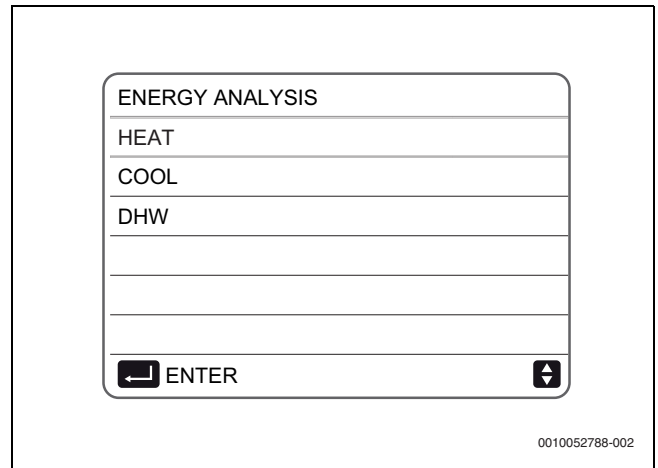



Fig. 224 ENERGY ANALYSIS - Available modes

**10.16.6 ENERGY ANALYSIS**

- ▶ Press .
- ▶ Select **FOR SERVICEMAN > 5. TEMP. TYPE SETTING > 5.4 ENERGY ANALYSIS**.
- ▶ Press **YES**.

The **ENERGY ANALYSIS** interfaces are the same for different modes.

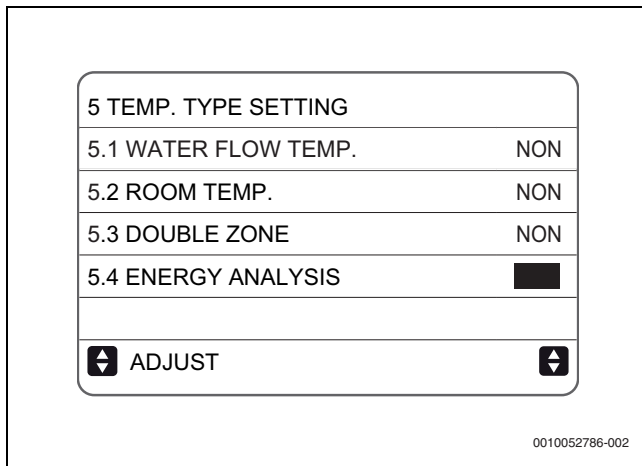

Fig. 222 5.4 ENERGY ANALYSIS

**ENERGY ANALYSIS** item appears in the

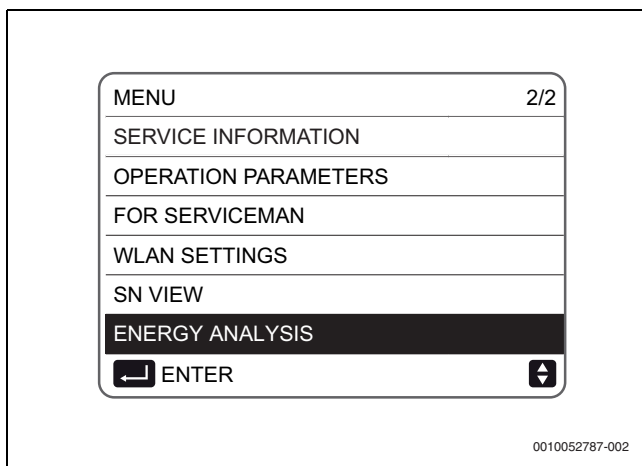

Fig. 223 ENERGY ANALYSIS

**ENERGY ANALYSIS** is available for heating, cooling and domestic hot water mode.

To check the **ENERGY ANALYSIS** of **HOURLY, TOTAL, DAY, WEEK, MONTH, YEAR, ANNALS** in sequence:

▶ Press

The screenshot shows a menu with six options for energy analysis, each with a list of metrics and a page indicator (e.g., 1/7, 2/7, 3/7, 4/7, 5/7, 6/7). The metrics include Energy Produced, RE Energy Produced, Power Consumed, and COP/EER. The 'TOTAL' option also includes 'OPERATION HOURS'. A 'CONFIRM' button is visible at the bottom left of the menu.

0010052789-002

Fig. 225 ENERGY ANALYSIS - Menu page 1 - 7

**ENERGY ANALYSIS ANNALS** include data in the past 10 years.

▶ Press for more details.

▶ Press to check the annual total data and different months' data.

▶ Press to check different years' data.

The screenshot shows two panels of data for 'ENERGY ANALYSIS ANNALS'. The left panel is for '2022 TOTAL' and the right panel is for '2022 JAN'. Both panels list metrics: Energy Produced, RE Energy Produced, Power Consumed, and COP/EER. At the bottom of each panel are 'MONTH' and 'YEAR' selection buttons.

0010052790-002

Fig. 226 ENERGY ANALYSIS ANNALS



The total energy analysis data is the cumulative data from the first time

when the unit starts to the current time.

Item	Mode	Explanation
<b>ENERGY PRODUCED</b>	Heating/DHW	Heating capacity (include electric heater capacity)
	Cooling	Cooling capacity
<b>RE ENERGY PRODUCED</b>	Heating/DHW	The raised heating capacity by heat pump compared to electric heater with the same amount of electricity consumed, which is for reference only.
	Cooling	The raised cooling capacity by heat pump compared to semiconductor refrigeration with the same amount of electricity consumed, which is for reference only.
<b>POWER CONSUMED</b>	Heating/DHW/Cooling	Total power consumption (include electric heater)
<b>COP/EER</b>	Heating/DHW	<b>COP</b> = Heating capacity / Total power consumption
	Cooling	<b>EER</b> = Cooling capacity / Total power consumption

Table 49 Parameter explanation

### 10.17 Service information

#### 10.17.1 SERVICE INFORMATION

The **SERVICE INFORMATION** menu includes the following functions:

- Service call: displays the contacts needed to call for assistance
- Error code: displays the meaning of the error codes
- Parameters: used to control the operation parameters
- Display: used to configure the display

To access:

- ▶ Select **MENU > SERVICE INFORMATION**.
- ▶ Press **OK**.

The following page appears.

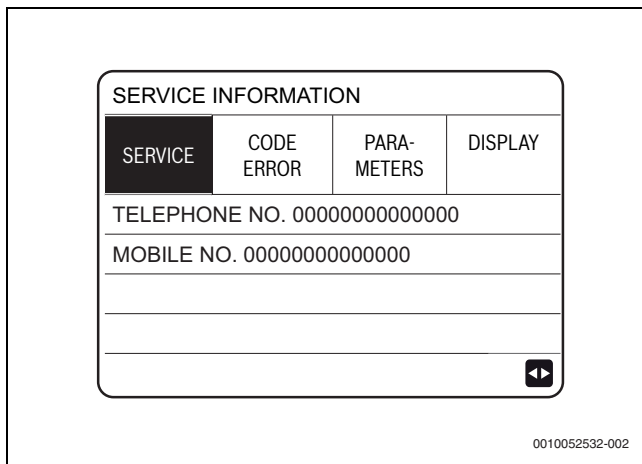

Fig. 227 SERVICE INFORMATION

#### 10.17.2 SERVICE CALL

In the **SERVICE CALL** area, the service centre number or a mobile phone number can be entered. The installer can enter his own telephone number.

- ▶ See the **FOR SERVICEMAN** menu.

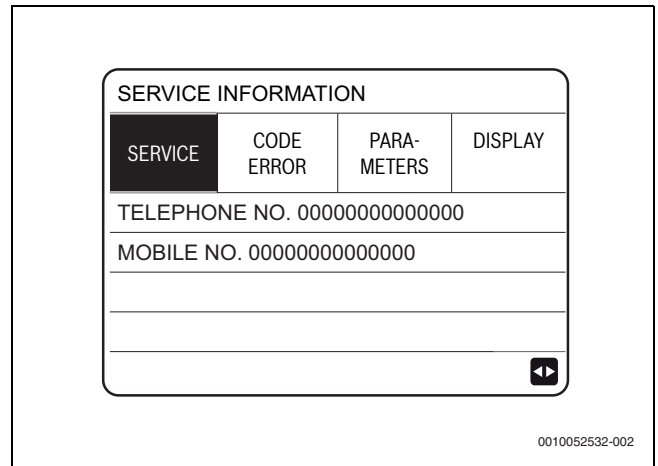

Fig. 228 SERVICE CALL

#### 10.17.3 ERROR CODE

The **ERROR CODE** displays the meaning of error codes in case of failure or malfunction.

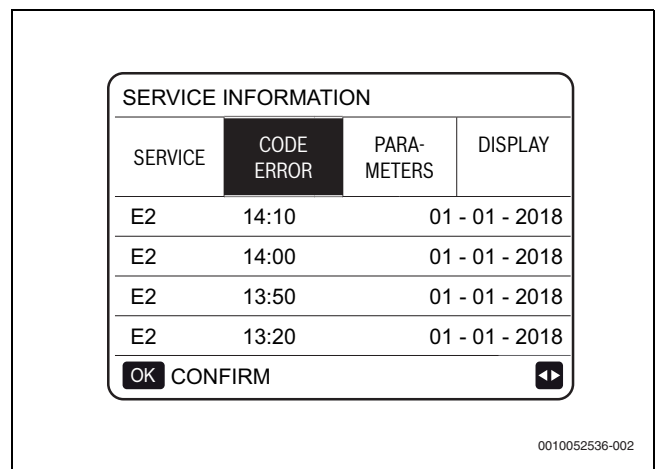

Fig. 229 ERROR CODE

- ▶ Press to scroll through the list of all recorded errors.

SERVICE INFORMATION 1/2			
SERVICE	CODE ERROR	PARA-METERS	DISPLAY
E2	14:10	01- 01 - 2018	
E2	14:00	01- 01 - 2018	
E2	13:50	01- 01 - 2018	
E2	13:20	01- 01 - 2018	
OK CONFIRM			

0010052537-002

Fig. 230 List of errors

- ▶ Press **OK** to display the meaning of the error code.

01-01-2021	9:00	13°
<p>E2 Communication error between the controller and the indoor unit</p> <p>Contact the serviceman.</p>		
OK CONFIRM		

0010052538-002

Fig. 231 Error code meaning



A total of eight error codes can be stored.

#### 10.17.4 PARAMETER

The **PARAMETER** function displays the main parameters, which are shown on two pages.

SERVICE INFORMATION 1/2			
SERVICE	CODE ERROR	PARA-METERS	DISPLAY
ROOM TEMP. SET			26°C
MAIN TEMP. SET			55°C
TANK TEMP. SET			55°C
CURR. ROOM TEMP.			24°C
OK CONFIRM			

0010052540-002

Fig. 232 PARAMETER - Menu page 1/2

SERVICE INFORMATION 2/2			
SERVICE	CODE ERROR	PARA-METERS	DISPLAY
CURR. MAIN TEMP.			26°C
CURR. TANK TEMP.			55°C
SMART GRID TIME			0 Hrs
OK CONFIRM			

0010052541-002

Fig. 233 PARAMETER - Menu page 2/2

#### 10.17.5 DISPLAY

The **DISPLAY** function is used to set the interface.

- ▶ Press **OK** to open the function.
- ▶ Press and to scroll and adjust the values.

SERVICE INFORMATION 1/2			
SERVICE	CODE ERROR	PARA-METERS	DISPLAY
TIME			9:00
DATE			01 - 01 - 2021
LANGUAGE			IT
BACKLIGHT			ON
OK CONFIRM			

0010052544-002

Fig. 234 DISPLAY - Menu page 1/2

SERVICE INFORMATION 2/2			
SERVICE	CODE ERROR	PARA-METERS	DISPLAY
BUZZER			ON
SCREEN-LOCKING TIME			120 SEC
SMART GRID TIME			2 hours
ON/OFF	ON/OFF		

0010052546-002

Fig. 235 DISPLAY - Menu page 2/2

#### 10.18 OPERATION PARAMETER

The **OPERATION PARAMETER** menu is used by the installer or the technician to check the operation parameters. The values shown on the pages are only indicative.



























On the home page:

- ▶ Select **MENU > OPERATION PARAMETER**.

- ▶ Press OK.  
The operation parameters are displayed.
- ▶ Press  to scroll.



The energy consumption parameter is calculated, not measured. If a parameter is not available for the system, the corresponding value will be "--". The heat pump capacity is indicative and should not be used as a measure of the unit's power. The accuracy of the sensor is  $\pm 1\text{ }^{\circ}\text{C}$ . The flow-rate parameters are calculated according to the pump operation parameters, the deviation is different at different flow-rates, the maximum deviation is 15%.

<table border="1"> <thead> <tr> <th colspan="2">OPERATION PARAMETERS</th> <th>1/9</th> </tr> </thead> <tbody> <tr><td>ONLINE UNITS NUMBER</td><td></td><td>0</td></tr> <tr><td>OPERATION MODE</td><td></td><td>DHW</td></tr> <tr><td>SV1 STATE</td><td></td><td>OFF</td></tr> <tr><td>SV2 STATE</td><td></td><td>OFF</td></tr> <tr><td>SV3 STATE</td><td></td><td>OFF</td></tr> <tr><td>PUMP_I</td><td></td><td>OFF</td></tr> <tr><td colspan="2"></td><td></td></tr> </tbody> </table>	OPERATION PARAMETERS		1/9	ONLINE UNITS NUMBER		0	OPERATION MODE		DHW	SV1 STATE		OFF	SV2 STATE		OFF	SV3 STATE		OFF	PUMP_I		OFF				<table border="1"> <thead> <tr> <th colspan="2">OPERATION PARAMETERS</th> <th>4/9</th> </tr> </thead> <tbody> <tr><td>T5 DHW WATER TANK TEMP.</td><td></td><td>25°C</td></tr> <tr><td>T 1B CIRCUIT2 WATER TEMP.</td><td></td><td>--°C</td></tr> <tr><td>T1S C1 CLIM.CURVE TEMP.</td><td></td><td>0°C</td></tr> <tr><td>T IS2 C2 CLIM. CURVE TEMP.</td><td></td><td>0°C</td></tr> <tr><td>TW_0 PLATE W-OUTLET TEMP.</td><td></td><td>0°C</td></tr> <tr><td>TW_I PLATE W-INLET TEMP.</td><td></td><td>0°C</td></tr> <tr><td colspan="2"></td><td></td></tr> </tbody> </table>	OPERATION PARAMETERS		4/9	T5 DHW WATER TANK TEMP.		25°C	T 1B CIRCUIT2 WATER TEMP.		--°C	T1S C1 CLIM.CURVE TEMP.		0°C	T IS2 C2 CLIM. CURVE TEMP.		0°C	TW_0 PLATE W-OUTLET TEMP.		0°C	TW_I PLATE W-INLET TEMP.		0°C				<table border="1"> <thead> <tr> <th colspan="2">OPERATION PARAMETERS</th> <th>7/9</th> </tr> </thead> <tbody> <tr><td>FAN SPEED</td><td></td><td>0 R/MIN</td></tr> <tr><td>IDU TARGET FREQU.</td><td></td><td>0 Hz</td></tr> <tr><td>FREQ.LIMITED TYPE</td><td></td><td>0</td></tr> <tr><td>SUPPLY VOLTAGE</td><td></td><td>0V</td></tr> <tr><td>DC GENERATRIX VOLTAGE</td><td></td><td>0V</td></tr> <tr><td>DC GENERATRIX CURRENT</td><td></td><td>0A</td></tr> <tr><td colspan="2"></td><td></td></tr> </tbody> </table>	OPERATION PARAMETERS		7/9	FAN SPEED		0 R/MIN	IDU TARGET FREQU.		0 Hz	FREQ.LIMITED TYPE		0	SUPPLY VOLTAGE		0V	DC GENERATRIX VOLTAGE		0V	DC GENERATRIX CURRENT		0A			
OPERATION PARAMETERS		1/9																																																																								
ONLINE UNITS NUMBER		0																																																																								
OPERATION MODE		DHW																																																																								
SV1 STATE		OFF																																																																								
SV2 STATE		OFF																																																																								
SV3 STATE		OFF																																																																								
PUMP_I		OFF																																																																								
																																																																										
OPERATION PARAMETERS		4/9																																																																								
T5 DHW WATER TANK TEMP.		25°C																																																																								
T 1B CIRCUIT2 WATER TEMP.		--°C																																																																								
T1S C1 CLIM.CURVE TEMP.		0°C																																																																								
T IS2 C2 CLIM. CURVE TEMP.		0°C																																																																								
TW_0 PLATE W-OUTLET TEMP.		0°C																																																																								
TW_I PLATE W-INLET TEMP.		0°C																																																																								
																																																																										
OPERATION PARAMETERS		7/9																																																																								
FAN SPEED		0 R/MIN																																																																								
IDU TARGET FREQU.		0 Hz																																																																								
FREQ.LIMITED TYPE		0																																																																								
SUPPLY VOLTAGE		0V																																																																								
DC GENERATRIX VOLTAGE		0V																																																																								
DC GENERATRIX CURRENT		0A																																																																								
																																																																										
<table border="1"> <thead> <tr> <th colspan="2">OPERATION PARAMETERS</th> <th>2/9</th> </tr> </thead> <tbody> <tr><td>PUMP_0</td><td></td><td>OFF</td></tr> <tr><td>PUMP_C</td><td></td><td>OFF</td></tr> <tr><td>PUMP_S</td><td></td><td>OFF</td></tr> <tr><td>PUMP_D</td><td></td><td>OFF</td></tr> <tr><td>PIPE BACKUP HEATER</td><td></td><td>OFF</td></tr> <tr><td>TANK BACKUP HEATER</td><td></td><td>OFF</td></tr> <tr><td colspan="2"></td><td></td></tr> </tbody> </table>	OPERATION PARAMETERS		2/9	PUMP_0		OFF	PUMP_C		OFF	PUMP_S		OFF	PUMP_D		OFF	PIPE BACKUP HEATER		OFF	TANK BACKUP HEATER		OFF				<table border="1"> <thead> <tr> <th colspan="2">OPERATION PARAMETERS</th> <th>5/9</th> </tr> </thead> <tbody> <tr><td>Tbt1 BUFFERTANK_UP TEMP.</td><td></td><td>0°C</td></tr> <tr><td>Tbt2 BUFFERTANK_LOW TEMP.</td><td></td><td>0°C</td></tr> <tr><td>Tsolar</td><td></td><td>0°C</td></tr> <tr><td>SOFTWARE</td><td></td><td>IDU 00-00-2000V00</td></tr> <tr><td colspan="2"></td><td></td></tr> </tbody> </table>	OPERATION PARAMETERS		5/9	Tbt1 BUFFERTANK_UP TEMP.		0°C	Tbt2 BUFFERTANK_LOW TEMP.		0°C	Tsolar		0°C	SOFTWARE		IDU 00-00-2000V00				<table border="1"> <thead> <tr> <th colspan="2">OPERATION PARAMETERS</th> <th>8/9</th> </tr> </thead> <tbody> <tr><td>TW_0 PLATE W-OUTLET TEMP.</td><td></td><td>0°C</td></tr> <tr><td>TW_I PLATE W-INLET TEMP.</td><td></td><td>0°C</td></tr> <tr><td>T2 PLATE F-OUT TEMP.</td><td></td><td>25°C</td></tr> <tr><td>T2B PLATE F-IN TEMP.</td><td></td><td>--°C</td></tr> <tr><td>T h COMP. SUCTION TEMP.</td><td></td><td>25°C</td></tr> <tr><td>Tp COMP. DISCHARGE TEMP.</td><td></td><td>25°C</td></tr> <tr><td colspan="2"></td><td></td></tr> </tbody> </table>	OPERATION PARAMETERS		8/9	TW_0 PLATE W-OUTLET TEMP.		0°C	TW_I PLATE W-INLET TEMP.		0°C	T2 PLATE F-OUT TEMP.		25°C	T2B PLATE F-IN TEMP.		--°C	T h COMP. SUCTION TEMP.		25°C	Tp COMP. DISCHARGE TEMP.		25°C									
OPERATION PARAMETERS		2/9																																																																								
PUMP_0		OFF																																																																								
PUMP_C		OFF																																																																								
PUMP_S		OFF																																																																								
PUMP_D		OFF																																																																								
PIPE BACKUP HEATER		OFF																																																																								
TANK BACKUP HEATER		OFF																																																																								
																																																																										
OPERATION PARAMETERS		5/9																																																																								
Tbt1 BUFFERTANK_UP TEMP.		0°C																																																																								
Tbt2 BUFFERTANK_LOW TEMP.		0°C																																																																								
Tsolar		0°C																																																																								
SOFTWARE		IDU 00-00-2000V00																																																																								
																																																																										
OPERATION PARAMETERS		8/9																																																																								
TW_0 PLATE W-OUTLET TEMP.		0°C																																																																								
TW_I PLATE W-INLET TEMP.		0°C																																																																								
T2 PLATE F-OUT TEMP.		25°C																																																																								
T2B PLATE F-IN TEMP.		--°C																																																																								
T h COMP. SUCTION TEMP.		25°C																																																																								
Tp COMP. DISCHARGE TEMP.		25°C																																																																								
																																																																										
<table border="1"> <thead> <tr> <th colspan="2">OPERATION PARAMETERS</th> <th>3/9</th> </tr> </thead> <tbody> <tr><td>GAS BOILER</td><td></td><td>OFF</td></tr> <tr><td>T1 LEAVING WATER TEMP.</td><td></td><td>--°C</td></tr> <tr><td>WATER FLOW</td><td></td><td>0.00M3/H</td></tr> <tr><td>HEAT PUMP CAPACITY</td><td></td><td>0.00kW</td></tr> <tr><td>POWER CONSUMPTION</td><td></td><td>0 kWh</td></tr> <tr><td>Ta ROOM TEMP.</td><td></td><td>--°C</td></tr> <tr><td colspan="2"></td><td></td></tr> </tbody> </table>	OPERATION PARAMETERS		3/9	GAS BOILER		OFF	T1 LEAVING WATER TEMP.		--°C	WATER FLOW		0.00M3/H	HEAT PUMP CAPACITY		0.00kW	POWER CONSUMPTION		0 kWh	Ta ROOM TEMP.		--°C				<table border="1"> <thead> <tr> <th colspan="2">OPERATION PARAMETERS</th> <th>6/9</th> </tr> </thead> <tbody> <tr><td>ODU MOD.</td><td></td><td>0 kW</td></tr> <tr><td>COMP.CURRENT</td><td></td><td>0 A</td></tr> <tr><td>COMP.FREQUENCY</td><td></td><td>0 Hz</td></tr> <tr><td>COMP. RUN TIME</td><td></td><td>0 MIN</td></tr> <tr><td>COMP. TOTAL RUN TIME</td><td></td><td>0 HOURS</td></tr> <tr><td>EXPANS.VALVE OPENING</td><td></td><td>0 P</td></tr> <tr><td colspan="2"></td><td></td></tr> </tbody> </table>	OPERATION PARAMETERS		6/9	ODU MOD.		0 kW	COMP.CURRENT		0 A	COMP.FREQUENCY		0 Hz	COMP. RUN TIME		0 MIN	COMP. TOTAL RUN TIME		0 HOURS	EXPANS.VALVE OPENING		0 P				<table border="1"> <thead> <tr> <th colspan="2">OPERATION PARAMETERS</th> <th>9/9</th> </tr> </thead> <tbody> <tr><td>T3 COIL F. TEMP.</td><td></td><td>25°C</td></tr> <tr><td>T3 OUTDOOR AIR TEMP.</td><td></td><td>25°C</td></tr> <tr><td>TF MODULE TEMP.</td><td></td><td>0°C</td></tr> <tr><td>P1 COMP. PRESS.</td><td></td><td>0 kPa</td></tr> <tr><td>ODU SOFTWARE</td><td></td><td>00-00-2000V00</td></tr> <tr><td>HMI SOFTWARE</td><td></td><td>24-02-2021V67</td></tr> <tr><td colspan="2"></td><td></td></tr> </tbody> </table>	OPERATION PARAMETERS		9/9	T3 COIL F. TEMP.		25°C	T3 OUTDOOR AIR TEMP.		25°C	TF MODULE TEMP.		0°C	P1 COMP. PRESS.		0 kPa	ODU SOFTWARE		00-00-2000V00	HMI SOFTWARE		24-02-2021V67			
OPERATION PARAMETERS		3/9																																																																								
GAS BOILER		OFF																																																																								
T1 LEAVING WATER TEMP.		--°C																																																																								
WATER FLOW		0.00M3/H																																																																								
HEAT PUMP CAPACITY		0.00kW																																																																								
POWER CONSUMPTION		0 kWh																																																																								
Ta ROOM TEMP.		--°C																																																																								
																																																																										
OPERATION PARAMETERS		6/9																																																																								
ODU MOD.		0 kW																																																																								
COMP.CURRENT		0 A																																																																								
COMP.FREQUENCY		0 Hz																																																																								
COMP. RUN TIME		0 MIN																																																																								
COMP. TOTAL RUN TIME		0 HOURS																																																																								
EXPANS.VALVE OPENING		0 P																																																																								
																																																																										
OPERATION PARAMETERS		9/9																																																																								
T3 COIL F. TEMP.		25°C																																																																								
T3 OUTDOOR AIR TEMP.		25°C																																																																								
TF MODULE TEMP.		0°C																																																																								
P1 COMP. PRESS.		0 kPa																																																																								
ODU SOFTWARE		00-00-2000V00																																																																								
HMI SOFTWARE		24-02-2021V67																																																																								
																																																																										

0010052529-002

Fig. 236 OPERATION PARAMETER

## 11 MODBUS registers

### 11.1 Controls

Address register	Meaning	Description	
0	ON/OFF	bit 15	Reserved
		bit 14	Reserved
		bit 13	Reserved
		bit 12	Reserved
		bit 11	Reserved
		bit 10	Reserved
		bit 9	Reserved
		bit 8	Reserved
		bit 7	Reserved
		bit 6	Reserved
		bit 5	Reserved
		bit 4	Reserved
		bit 3	0= off (T2S); 1= on (T2S) (WATER FLOW TEMP control - zone 2)
		bit 2	0= DHW (T5S) off; 1= DHW (T5S) on
		bit 1	0= off (T1S); 1= on (T1S) (WATER FLOW TEMP control - zone 1)
bit 0	0= off (TS) 1= on (TS) (ROOM TEMP thermostat control)		
1	Operation mode	1: auto; 2: Cooling ; 3: heating ; other value: invalid	
2	Set water temp. T1s	bit8-bit15	Water temp. T1s setting for ZONE 2
		bit0-bit7	Water temp. T1s setting for ZONE 1
3	Set air temperature Ts	Room temperature setting, when a valid Ta is present, 17 °C ~ 30 °C transmission value equal to actual value * 2; 35 is transmitted, e.g.17.5 °C	
4	T5s	Storage tank water temperature setting, 20 °C ~ 60/75 °C (EDGE A with AHS can be set at 75°C, other unit at 60 °C) Default = 50 °C	
5	Function settings	bit 15	Reserved
		bit 14	Reserved
		bit 13	1 = ZONE 2 curve on; 0 = ZONE 2 curve disabled
		bit 12	1 = ZONE 1 curve on; 0 = ZONE 1 curve disabled
		bit 11	DHW pump operating with return water at constant temperature
		bit 10	ECO mode
		bit 9	Reserved
		bit 8	Holiday at home (read only, cannot be changed)
		bit 7	0= silent level1; 1= silent level2
		bit 6	Silent mode
		bit 5	Going on holiday (read only, cannot be changed)
		bit 4	Sterilisation (disinfection)
		bit 3	Reserved
		bit 2	Reserved
		bit 1	Reserved
bit 0	Reserved		
6	Curve selection	bit8-bit15	ZONE 2 Curves 1- 9
		bit0-bit7	ZONE 1 Curves 1- 9
7	Forced hot water	0 invalid	TBH is the electric heater inside the storage tank,
8	Forced TBH	1 forced ON	IBH is the heating backup electric heater
9	Forced IBH	2 forced OFF	TBH and IBH cannot be forced together
10	SG operation time	0-24hrs	
11	Set the water temperature T1s zone1	Water temperature T1s setting for ZONE 1	
12	Set the water temperature T1s zone2	Water temperature T1s setting for ZONE 2	

Table 50 Controls

**11.2 States**

Address register	Meaning	Description																																
100	Operating frequency	Compressor operating frequency in Hz. Value read = current value																																
101	Operation mode	Unit's operation mode, 0: shut down 2: cooling 3: heating																																
102	Fan speed	Fan speed, unit: rpm. Value read = current speed value																																
103	PMV	ODU electronic expansion valve opening, unit: P. Value read = current value (shows only 8 multiples. Only multiples of 8 will be shown)																																
104	Entering water temperature	TW_in, unit: °C; value read = current value																																
105	Leaving water temperature	TW_out, unit: °C; value read = current value																																
106	T3 temperature	Condenser temperature in °C. Value read = current value																																
107	T4 temperature	Outdoor temperature, unit: °C. Value read = current value																																
108	Discharge gas temperature	Compressor discharge temperature Tp, unit: °C. Value read = current value																																
109	Intake gas temperature	Compressor suction temperature Th, unit: °C. Value read = current value																																
110	T1	Leaving water temperature, unit: °C. Value read = current value																																
111	T1B	Leaving water temperature (after additional heat source), unit: °C. Value read = current value																																
112	T2	Liquid refrigerant temperature, unit: °C. Value read = current value																																
113	T2B	Gas refrigerant temperature, unit: °C. Value read = current value																																
114	Ta	Outdoor temperature, unit: °C. Value, read = current value																																
115	T5	Storage tank water temperature																																
116	Pressure value 1	ODU high pressure value, unit: kPa. Value read = current value																																
117	Pressure value 2	ODU high pressure value, unit: kPa. Value read = current value (reserved)																																
118	ODU current	Current ODU value, unit: A, Value read = current value																																
119	ODU voltage	ODU voltage value, unit: V. Value read = current value (reserved)																																
120	Tbt1	Tbt1 unit: °C. Value read = current value																																
121	Tbt2	Tbt2 unit: °C. Value read = current value																																
122	Compressor running time	Compressor running time, unit: hour, value read = current value																																
123	Unit	Register 200 is reserved for type 0702 and the value for type 071X represents the capacity of type 4-30 represents 4-30KW																																
124	Error code	Specific error code, refer to the code table.																																
125	Error code 2																																	
126	Error code 2																																	
127	Error code 3																																	
128	Status bit: 1	<table border="1"> <tbody> <tr> <td>BIT15</td> <td>Ask for installation parameter, 1: ask; 0: don't ask</td> </tr> <tr> <td>BIT14</td> <td>Load software version, 1: ask; 0: don't ask</td> </tr> <tr> <td>BIT13</td> <td>Load SN, 1: ask; 0: don't ask</td> </tr> <tr> <td>BIT12</td> <td>Reserved</td> </tr> <tr> <td>BIT11</td> <td>EVU 1: electricity (from photovoltaics) 0: based on SG signal</td> </tr> <tr> <td>BIT10</td> <td>SG 1: normal electric price 0: high electric price</td> </tr> <tr> <td>BIT9</td> <td>Storage tank water antifreeze</td> </tr> <tr> <td>BIT8</td> <td>Solar signal input</td> </tr> <tr> <td>BIT7</td> <td>Room thermostat in cooling mode</td> </tr> <tr> <td>BIT6</td> <td>Room thermostat in heating mode</td> </tr> <tr> <td>BIT5</td> <td>ODU test mode</td> </tr> <tr> <td>BIT4</td> <td>Remote ON/OFF (1 : d8)</td> </tr> <tr> <td>BIT3</td> <td>Oil return</td> </tr> <tr> <td>BIT2</td> <td>Antifreeze</td> </tr> <tr> <td>BIT1</td> <td>Defrosting</td> </tr> <tr> <td>BIT0</td> <td>Recirculation pump</td> </tr> </tbody> </table>	BIT15	Ask for installation parameter, 1: ask; 0: don't ask	BIT14	Load software version, 1: ask; 0: don't ask	BIT13	Load SN, 1: ask; 0: don't ask	BIT12	Reserved	BIT11	EVU 1: electricity (from photovoltaics) 0: based on SG signal	BIT10	SG 1: normal electric price 0: high electric price	BIT9	Storage tank water antifreeze	BIT8	Solar signal input	BIT7	Room thermostat in cooling mode	BIT6	Room thermostat in heating mode	BIT5	ODU test mode	BIT4	Remote ON/OFF (1 : d8)	BIT3	Oil return	BIT2	Antifreeze	BIT1	Defrosting	BIT0	Recirculation pump
BIT15	Ask for installation parameter, 1: ask; 0: don't ask																																	
BIT14	Load software version, 1: ask; 0: don't ask																																	
BIT13	Load SN, 1: ask; 0: don't ask																																	
BIT12	Reserved																																	
BIT11	EVU 1: electricity (from photovoltaics) 0: based on SG signal																																	
BIT10	SG 1: normal electric price 0: high electric price																																	
BIT9	Storage tank water antifreeze																																	
BIT8	Solar signal input																																	
BIT7	Room thermostat in cooling mode																																	
BIT6	Room thermostat in heating mode																																	
BIT5	ODU test mode																																	
BIT4	Remote ON/OFF (1 : d8)																																	
BIT3	Oil return																																	
BIT2	Antifreeze																																	
BIT1	Defrosting																																	
BIT0	Recirculation pump																																	

Address register	Meaning	Description
129	Load output	BIT15 Defrosting
		BIT14 External heat source
		BIT13 Compressor on
		BIT12 ALARM
		BIT11 Solar pump Pump_S
		BIT10 HEAT4
		BIT9 SV3
		BIT8 Mixing pump P_c
		BIT7 Recirculation pump P_d
		BIT6 External pump P_o
		BIT5 SV2
		BIT4 SV1
		BIT3 Standard unit pump Pump_l
		BIT2 TBH
		BIT1 IBH2
BIT0 IBH		
130	IDU software version	0 - 99 Indicates the software version of the indoor unit
131	HMI software version	0 - 99 Indicates the software version of the user interface
132	Unit target frequency	Compressor target frequency in Hz. Send value = actual value
133	DC bus current	Unit: Amps
134	DC bus voltage	Return value = actual value / 10 (Unit: Volts)
135	TF module temperature	Unit (°C) - External feedback to unit
136	Curve 1T1S	Value read = current value
137	Curve 2T1S	Value read = current value
138	Water flow	Value read = current value* 100 [unit: m <sup>3</sup> /hour]
139	ODU frequency limitation	Diagram value ----- ODU feedback 174
140	IDU capacity	Value read = current value* 100 unit: kW
141	Solar T	
142	Number of units in cascade	BIT1-BIT15 represents the online/offline state of 1-1 5 units BIT0 Reserved
143	High bit of electrical	Energy consumption
144	Low bit of electrical	
145	High bit of heat	Heating capacity of the system
146	Low bit of heat	
147	AHS power supply output to EDGE series	Value read = current value* 10 (unit: V)

Table 51 States

### 11.3 States of units in cascade

Address register	Meaning	Description
1000	Operation mode	Operation mode, 2: cool, 3: heat; 0: OFF
1001	Comp. Frequ.	Comp.freq., unit: Hz, (value read = current value)
1002	Tw <sub>i</sub>	TW <sub>in</sub> , unit: °C entering water temperature; (value read = current value)
1003	Two	TW <sub>out</sub> , unit: °C leaving water temperature; (value read = current value)
1004	Tsolar	Tsolar, unit: °C solar temperature; (value read = current value)
1005	Save unit error code	Specific error code, refer to the code table.
1006	P6 error	Reserved
1007	IDU state 1	Bit3~7 Reserved
		Bit2 Oil return
		Bit1 Antifreeze
		Bit0 Defrosting

Address register	Meaning	Description	
1008	IDU status 2	Reserved	
		Reserved	
		Reserved	
		Reserved	
		Bit4	T1 leaving water temperature; 1- enabled; 0- disabled
		Bit3	IBH backup system electric heater; 1- enabled; 0- disabled
		Bit2	DHW
		Bit0	Cool
1009	IDU load	Bit7	HEAT 4 compressor heater 1- on; 0- off
		Reserved	
		Bit5	Defrosting 1- on; 0- off
		Bit4	RUN 1- on; 0- off
		Bit3	PUMP_I 1- on; 0- off
		Reserved	
		Bit0	IBH1 = 1- on; 0- off
1010	IDU load output - Reserved	Reserved	
		Reserved	
		Reserved	
		Reserved	
		Reserved	
		Reserved	
		Reserved	
		Reserved	
1011	T1	Total leaving water, unit: °C, (value read = current value);invalid: 0x7F	
1012	T1B	Total leaving water (after additional heat source), unit: °C. (value read = current value); invalid: 0x7F	
1013	T2	Refrigerant liquid temperature, unit: °C. (value read = current value); invalid: 0x7F	
1014	T2B	Refrigerant gas temperature, unit: °C. (value read = current value); invalid: 0x7F	
1015	T5	Storage tank temperature, unit: °C. (value read = current value); invalid: 0x7F	
1016	Ta	Indoor air temperature, unit: °C. (value read = current value); invalid: 0x7F	
1017	Tbt1	Inertial storage tank temperature, unit: °C. (value read = current value); invalid: 0x7F	
1018	Tbt2	Additional storage tank temperature, unit: °C. (value read = current value); invalid: 0x7F	
1019	Water flow	(value read = current value)* 100, unit: M3/H	
1020	Unit type	10-18 : means 10-18KW	
1021	Unit target frequency		
1022	Software version	1~99 means IDU software version	
1023	High bit of capacity		
1024	Low bit of capacity		
1025	IDU capacity	(value read = current value) *100, unit: KW	
1026	Fan rpm	Fan speed, (value read = current value)	
1027	PMV	ODU EXV opening, unit: Pulse. R & Lt (value read = current value) (shows only 8 multiples. Only multiples of 8 will be shown)	
1028	T3	Coil temperature, unit: °C	
1029	T4	Outdoor temperature, unit: °C	
1030	Tp	Discharge temperature Tp, unit: °C	
1031	Th	Suction temperature, unit: °C	
1032	TF	Unit (°C) ---- External unit feedback invalid value 0x7F	
1033	Pressure 1	ODU high pressure, unit: kPA. (value read = current value)	
1034	Pressure 2	ODU low pressure, unit: kPA. (value read = current value) (reserved)	
1035	DC bus current	Unit: amps	
1036	DC bus voltage	(value read = current value) (unit:V)	
1037	ODU current	Operating power supply, unit: A (value read = current value)	
1038	ODU voltage	Unit voltage: V (value read = current value)	

Address register	Meaning	Description
1039	ODU frequency limitation solution	Solution read from ODU 174
1040	High bit of electrical computation	
1041	Low bit of electrical computation	
1042	ODU software version	

Table 52 States of units in cascade

### 11.4 Alarms

In the event of malfunctions, alarms are indicated by the appearance of the “Active alarm” symbol on the multifunction keypad.

To view the alarms:

- ▶ Select **MENU > SERVICE INFORMATION**.



Before resetting an alarm:

- ▶ Identify and remove the cause of the alarm.

To reset an alarm:

- ▶ Remove the cause of the alarm.
- ▶ Reset the active alarm.

**NOTICE**

**Damage due to repeated resets!**

Repeated resets can lead to irreversible damage such as malfunction of the system itself.

- ▶ If in doubt, contact a service centre.

Error code	Description	Modbus code
E0	Water flow failure (water flow failure 3 times)	1
E1	Line-to-line or zero phase error (three-phase models have this error code)	33
E2	Communication error between user interface and hydraulic module	2
E3	Leaving water temperature sensor T1 failure	4
E4	Storage tank water temperature sensor T5 failure	5
E5	Unit temperature sensor T3 failure	39
E6	Unit room temperature sensor T4 failure	40
E7	Inertial storage tank sensor Tbt1 failure	6
E8	Water flow failure (displayed three times and can be reset after minutes)	9
E9	Temperature sensor Th failure	41
EA	Unit air temperature sensor Tp failure	42
Eb	Tsolar sensor failure	7
EC	DHW additional storage tank sensor Tbt2 failure	8
Ed	Water temperature sensor Twin board replacement failure	10
EE	EEPROM hydraulic module failure	11
P0	Low pressure protection	50
P1	Discharge temperature/high pressure control switch protection	52
P3	Compressor overcurrent protection	53
P4	Exhaust air temperature overheating protection Tp	54
P5	Twin-Twout, Twout-Twin protection or water supply temperature too high	25
P6	Module protection (IPDU and IR341)	55
Pb	Antifreeze (this is not a protection, the alarm light does not flash), the remote control does not display Pb, but displays the antifreeze icon;	25
Pd	Unit T3 over-temperature protection	57
PP	Abnormal temperature difference between entering and leaving water	31
H0	Communication error between indoor unit and unit (continuous communication error for 10 seconds)	3
H0	Communication error between unit and indoor unit (no communication in 10 seconds)	38
H1	Communication error between unit and IR341 (unit and inverter module)	39
H2	Gas side refrigerant temperature sensor T2 failure	12
H3	Liquid side refrigerant temperature sensor T2B failure	13
H4	After 3 L signals (L0/L1) in 1 hour, H4 appears, which cannot be reset. After H4 it is possible to check the last 3 L signals (not only L0, L1). For example: L0-L4-L8-L9-L0-L1 signalling in 1 hour, H4 fault signalling. The faults to be checked are L9, L0, L1.	44
H5	Temperature sensor Ta failure	15
H6	DC fan failure	45
H7	Abnormal power supply voltage	46

Error code	Description	Modbus code
H8	High pressure sensor failure	47
H9	Sensor Tw2 failure	20
HA	Plate exchanger outlet temperature sensor failure	14
Hb	Three consecutive faults PP protection and Twout < 7 °C; reset for power failure;	21
Hd	Communication error between slave and master (this error occurs when several units are connected in parallel)	24
HE	Communication error between hydraulic module and hydraulic module adapter board	23
HF	Unit EEPROM failure	43
HH	H6 failure 10 consecutive times in 120 minutes (reset after shut down)	48
HP	Cooling mode low pressure protection (in 1 hour, low pressure is below 0.6 MPa three consecutive times, can be reset automatically)	49
C7	Heat sink over-temperature protection	65
bH	PED board failure	143
F1	DC bus low voltage protection	142
L0	DC compressor module error	112
L1	DC bus low voltage protection	116
L2	DC bus high voltage protection	134
L4	MC/synchronisation/closed circuit error	135
L5	Zero speed protection	136
L7	Phase sequence error protection	138
L8	Protection for when the preceding and following speed variation is >15 Hz	139
L9	Protection for when the difference between the set speed and the operating speed is >15 Hz	141
C0	Multiple units configured as Master in the M/S network.	58

Table 53 Alarms

### 11.5 Password-protected unit parameters

The unit leaves the factory with the unit parameters set by default to values capable of fulfilling most installation situations. For detailed customisation of the system, however, it is possible to make changes; a list of all the unit parameters, with the available settings, is given below.

Depending on the configuration of the unit, some parameters are visible and others are not.



Access to parameters or modifications are only allowed to a qualified serviceman who assumes all responsibility, in case of doubt contact Bosch Group. For any changes not permitted or not approved declines any responsibility for malfunctions and/or damage to the unit/system and to people.

Address register	Meaning	Description
200	Type of Unit	reserved, factory data
201	T1S Upper temperature limit set in cooling mode	The 8 low bits represent zone 1 and the 8 high bits represent zone 2. The 8 low bits represent area 1 and the 8 high bits represent area 2.
202	T1S Lower temperature limit set in cooling mode	The 8 low bits represent zone 1 and the 8 high bits represent zone 2. The 8 low bits represent area 1 and the 8 high bits represent area 2.
203	T1S Upper temperature limit set in heating mode	The 8 low bits represent zone 1 and the 8 high bits represent zone 2. The 8 low bits represent area 1 and the 8 high bits represent area 2.
204	T1S Lower temperature limit set in heating mode	The 8 low bits represent zone 1 and the 8 high bits represent zone 2. The 8 low bits represent area 1 and the 8 high bits represent area 2.
205	TS Set the upper temperature limit	Reading = actual*2 actual value *2
206	TS Set the lower temperature limit	Reading = actual*2 actual value *2
207	DHW upper temperature limit	
208	DHW lower temperature limit	
209	Recirculation pump operating time	Recirculation pump, default operating time 5 minutes, adjustment range 5 - 120 min, with steps of 1 min

Address register	Meaning	Description
210	Parameter setting 1	BIT15 DHW enabling/disabling
		BIT14 Storage tank water electric heater TBH (read only)
		BIT13 Disinfect function
		BIT12 DHW pump; 1=enabled ; 0=disabled
		BIT11 Reserved
		BIT10 The DHW pump supports pipe disinfection
		BIT9 Cooling mode enabling
		BIT8 T1S cooling mode high/low temperature control (read only) zone 1
		BIT7 Heating mode enabling
		BIT6 T1S heating mode high/low temperature control (read only) zone 1
		BIT5 Backup PUMPI silent pump function, 1:backup
		BIT4 Backup room temperature sensor Ta
		BIT3 Room thermostat (Room thermostat)
		BIT2 Room thermostat - MODE SETTING
		BIT1 Double room thermostat, 1=enabled; 0=disabled
		BIT0 0: Room cooling and heating priority; 1: Hot water priority
210	Parameter setting 2	BIT15 DHW (double DHW double enabling) 1: Yes 0: No
		BIT14 DHW control M1M2 potential-free contact 1: Yes 0: No
		BIT13 RT_Ta_PCNE (Enable small temperature board)
		BIT12 Sensor Tbt2 enabling 1: Yes 0: No
		BIT11 Selection of pipe length 1:> 10 m 0: <10 m
		BIT10 Solar input port 1: CN18 0: CN11
		BIT9 Solar module 1: Yes 0: No
		BIT8 Definition of the input port: 0= remote switch 1= DHW heater
		BIT7 Smart grid: 0= None 1= Yes
		BIT6 T1B Sensor enabling 0= None 1= Yes
		BIT5 T1S High/low cooling temp. setting zone 2
		BIT4 T1S High/low heating temp. setting zone 2
		BIT3 Double zone setting is effective
		BIT2 Ta Sensor position 1: IDU 0: HMI
		BIT1 Tbt Sensor enabling 1: Yes 0: No
		BIT0 IBH / AHS Installation position 1: storage tank 0: piping
212	dT5_On	A Series: Default: 10 °C range: 1 ~ 30 °C E series: Default: 5 °C, range: 2 ~ 0 °C control range 1 °C
213	dT1S5	Default: 10 °C, range: 5-40 °C, Control range 1 °C
214	T_Interval_DHW	Default: 5min, interval: 5~5min, Control interval 1min
215	T4DHWmax	Default: 43 °C, range: 35-43 °C, Control range 1 °C
216	T4DHWmin	A Series: Default: -10 °C range: -25 ~ 30 °C E series: Default: -10 °C, range: -25-5 °C control range 1 °C
217	t_TBH_delay	Default: 30min interval: 0~240min, Control interval 5min
218	dT5S_TBH_off	Default: 5 °C, range: 0~10 °C, Control range 1 °C
219	T4_TBH_on	A Series: Default: 5 °C range: -5 ~ 50 °C E series: Default: 5 °C, range: 5 ~ 20 °C control range 1 °C
220	T5s_DI	Storage tank water temp. setting for disinfect function. Default: 65 °C, Control range : 60~70 °C
222	t_DI_hightemp	High temperature disinfect time. Default: 15min; Control interval 5~60min
223	t_interval_C	Compressor start time interval in cooling mode. Default value 5min; interval: 5 ~ 5min
224	dT1SC	Default: 5 °C, range: 2-10 °C, Control range 1 °C
225	dTSC	Default:2 °C, range:1-10 °C, Control range 1 °C
226	T4cmax	Default: 52 °C, range: 35-52 °C, Control range 1 °C
227	T4cmin	Default: -5 °C, range: -5-25 °C, Control range 1 °C

Address register	Meaning	Description
228	t_interval_H	Compressor start time interval in heating mode. Default value 5min; interval: 5 ~ 5min
229	dT1SH	A Series: Default: 5 °C range: 2-20 °C E series: Default: 5 °C, range: 2-10 °C control range 1 °C
230	dTSH	Default: 2 °C, range: 1-10 °C, Control range 1 °C
231	T4hmax	Default: 25 °C, range: 20-35 °C, Control range 1 °C
232	T4hmin	A Series: Default: -1.5 °C, range: -25-30 °C control range 1 °C E Series: Default: -1.5 °C, range: -25-15 °C control range 1 °C
233	T4_IBH_on	Outdoor temperature for starting the backup heater IBH. Default value: -5 °C; control range: -15 ~ 10 °C
234	dT1_IBH_on	IBH indoor unit backup electric heater switch-on temperature hysteresis, setting range: 2~10 °C, default value is 5 °C
235	t_IBH_delay	Compressor operation time before starting the backup heater. Default value 30min; control range: 15 ~ 120min
236	t_IBH12_delay	Reserved
237	T4_AHS_on	Room temperature for starting the additional heating source AHS. A series: range: -15 ~ 30 °C E series: control range -15 ~ 10 °C Default value is 10 °C, Midea model -5 °C
238	dT1_AHS_on	The temperature difference for starting the additional heating source AHS. A Series: Default value 5 °C; range: 2 ~ 20 °C E series: Default value 5 °C; control range: 2 ~ 10 °C
239	dT1_AHS_off	Reserved
240	t_AHS_delay	Compressor operation time before starting the additional heating source. Default value 30min; control range 5 ~ 120min.
241	t_DHWHP_max	Maximum operating time for the heat pump to run hot water. Default value: 90min; control range: 10 ~ 600 min; Set value in minutes
242	t_DHWHP_restrict	Maximum operating time of the heat pump in heating/cooling mode. Default value: 30min; control setting: 10 ~ 600 min; Set value in minutes
243	T4autocmin	Default value: 25 °C, range: 20~29 °C, Control range 1 °C
244	T4autohmax	Default value: 17 °C, range: 10~17 °C, Control range 1 °C
245	T1S_H.A_H	T1 value in heating mode during holidays; Default 25 °C; Control range : 20~25 °C.
246	T5S_H.A_DHW	T5 value in hot water mode during holidays Default 25 °C; Control range : 20~25 °C.
247	Start percentage	Default value 10; range 10-100, Control range 10
248	Adjustment time	Default value 5; Interval 1-60
249	dTbt2	Default value 15; range 0-50
250	IBH1 power	Default value 0; range 0-200; unit 100W
251	IBH2 power	Default value 0; range 0-200; unit 100W
252	TBH power	Default value 0; range 0-200; unit 100W
253	Comfort parameter	Reserved, query this register to report address errors
254	Comfort parameter	Reserved, query this register to report address errors
255	t_DRYUP	Heating days; Default 8 days; Control interval: 4 ~ 15 days
256	t_HIGHPEAK	Floor drying days. Default 5 days, Control interval: 3 ~ 7 days
257	t_DRYD	Cooling days. Default 5 days. Control interval: 4~ 15 days
258	T_DRYPEAK	Max floor drying temperature. Default 45 °C; Control range: 30-55 °C.
259	t_firstFH	Time of first floor heating. Default value 72 hours; control interval 48-96 hours
260	T1S(First warm)	Leaving water temperature for preheating radiant panels. Default: 25 °C; Control range 25~35 °C
261	T1SetC1	Temperature curve parameters in cooling mode 9, Range setting 5-25 °C, default 10 °C
262	T1SetC2	Temperature curve parameters in cooling mode 9, Range setting 5-25 °C, default 16 °C
263	T4C1	Temperature curve parameters in cooling mode 9, Range setting (-5)-46 °C, default 35 °C
264	T4C2	Temperature curve parameters in cooling mode 9, Range setting (-5)-46 °C, default 25 °C
265	T1SetH1	Temperature curve parameters in heating mode 9, Range setting 25-60 °C, default 35 °C
266	T1SetH1	Temperature curve parameters in heating mode, Range setting 25-60 °C, default 28 °C
267	T4H1	Temperature curve parameters in heating mode, Range setting (-25)-35 °C, default -5 °C
268	T4H2	Temperature curve parameters in heating mode, Range setting (-25)-35 °C, default -7 °C
269		Current limitation scheme, 0= no setting; 1~8= Scheme 1~8, predefined 0

Address register	Meaning	Description
270	HB: t_T4_FRESH_C	Interval setting 0.5 - 6 hours, send value = current value * 2
	LB: t_T4_FRESH_H	Interval setting 0.5 - 6 hours, send value = current value * 2
271	T_PUMPL_DELAY	Interval setting 2-20, send value = current value * 2
272	EMISSION TYPE	Bit12-15= Zone 2 Type of cooling terminal
		Bit8-11= Zone 1 Type of cooling terminal
		Bit4-7= Zone 2 Type of heating terminal
		Bit0-3= Zone 1 Type of heating terminal

Table 54 Password-protected unit parameters

## 12 Maintenance

To ensure optimal availability of the unit:

- ▶ Carry out a series of checks and inspections periodically on both the unit and the electrical connections.



These maintenance procedures must be carried out by a qualified serviceman.



### WARNING

#### ELECTROCUTION DANGER

- ▶ Before performing any maintenance or repair work, switch off the main power panel switch, remove the fuses (or switch off the circuit breakers) or open the unit's protection devices.
- ▶ Before starting any maintenance or repair work, make sure that the unit is switched off.
- ▶ After disconnecting the power supply, wait 10 minutes before touching live parts to avoid risks due to residual voltages in the DC bus condensers of the compressor inverter.
- ▶ Note that some sections of the electrical box are very hot. The same applies to the components of the high pressure refrigeration circuit. Consider the risk of burns and wear personal protective equipment before carrying out any work in these areas.
- ▶ Do not touch the conductive sections.
- ▶ Do not rinse the unit. Humidity can cause an electric shock or a fire risk.
- ▶ When removing the service panels, there is a risk of accidentally touching live components.
- ▶ When installing or servicing, never leave the unit unattended after removing the service panels.

#### The checks described should be carried out at least once a year by a qualified technician.

Water pressure	<ul style="list-style-type: none"> <li>▶ Check that the water pressure is greater than 1 bar.</li> <li>▶ If necessary, add water up to 1.5-1.8 bar.</li> </ul>
Water filter	<ul style="list-style-type: none"> <li>▶ Check and clean the water filter.</li> </ul>
Pressure relief valve	<p>To check that the pressure relief valve is working properly:</p> <ul style="list-style-type: none"> <li>▶ Turn the black knob on the valve anticlockwise.</li> </ul> <p>If you do not hear a click:</p> <ul style="list-style-type: none"> <li>▶ Contact your local dealer.</li> </ul> <p>If water continues to leak out of the unit:</p> <ul style="list-style-type: none"> <li>▶ Close the shut-off valves at the water inlet and outlet.</li> <li>▶ Contact your local dealer.</li> </ul>
Pressure relief valve pipe	<ul style="list-style-type: none"> <li>▶ Check that the pressure relief valve pipe is correctly positioned for draining the water.</li> </ul>
Insulating backup heater cover	<ul style="list-style-type: none"> <li>▶ Check that the insulating cover of the built-in backup heater is tightly closed around the heater housing.</li> </ul>
Domestic hot water storage tank pressure relief valve	<p>Only for installations with domestic hot water storage tank.</p> <ul style="list-style-type: none"> <li>▶ Check that the pressure relief valve on the domestic hot water storage tank is working properly.</li> </ul>
Domestic hot water storage tank booster heater	<p>Only for installations with domestic hot water storage tank.</p> <p>It is advisable to remove limescale build-up from the booster heater to prolong its life, especially in hard water areas:</p> <ul style="list-style-type: none"> <li>▶ Empty the domestic hot water storage tank.</li> <li>▶ Remove the booster heater from the storage tank.</li> <li>▶ Immerse it in a bucket (or other container) with limescale removal product for 24 hours.</li> </ul>
Unit control box	<ul style="list-style-type: none"> <li>▶ Visually inspect the control box for any obvious defects, e.g. loose connections or faulty electrical connections.</li> <li>▶ Check that the contactors are working properly with an ohmmeter.</li> <li>▶ All contactor contacts must be in the open position.</li> </ul>

The checks described should be carried out at least once a year by a qualified technician.	
Using glycol	<ul style="list-style-type: none"> <li>▶ Document the glycol concentration and pH value of the system at least once a year.                             <ul style="list-style-type: none"> <li>– A pH value below 8.0 indicates that a significant proportion of the inhibitor has been consumed and should be topped up.</li> <li>– A pH value of less than 7.0 indicates that the glycol has oxidised; in this case it is recommended to drain and flush the system thoroughly to prevent serious damage.</li> </ul> </li> <li>▶ The glycol solution must be disposed of in accordance with the local laws and regulations in force.</li> </ul>
Flow switch	→ Chapter 7, page 46

Table 55 Maintenance

### 13 Troubleshooting

This section contains useful information for diagnostics and correcting certain problems that may occur in the unit.

 Diagnostic procedures and associated corrective actions can only be carried out by the local technician.

#### General guidelines

Before starting the troubleshooting procedure:

- ▶ Visually inspect the unit for any obvious defects, e.g. loose connections or faulty electrical connections.

 **WARNING**  
When inspecting the unit's control box:  
▶ Always make sure that the main switch is off.

If a safety device has been activated:

- ▶ Shut down the unit and identify the cause before resetting it.

 Under no circumstances may safety devices be jumpered or adjusted to values different to the factory settings.

- ▶ If you cannot identify the cause of the problem, contact your local dealer.

If the pressure relief valve is not working properly and needs to be replaced:

- ▶ Always reconnect the hose connected to the pressure relief valve to prevent water dripping from the unit while waiting for the replacement.

 For problems related to the unit's optional kits:  
▶ Refer to the specific kit installation and operating manuals.

#### 13.1 General problems

Problems	Possible causes	Corrective action
The unit is switched on but does not heat or cool as expected	The set temperature is not correct.	<ul style="list-style-type: none"> <li>▶ Check the setpoint of the control unit:                             <ul style="list-style-type: none"> <li>– T4HMAX, T4HMIN in Heating mode.</li> <li>– T4CMAX, T4CMIN in Cooling mode.</li> <li>– T4DHWMAX, T4DHWMIN in DHW mode.</li> </ul> </li> </ul>
	The water flow-rate is insufficient.	<ul style="list-style-type: none"> <li>▶ Check that all shut-off valves in the water circuit are fully open.</li> <li>▶ Check that the water filter is clean.</li> <li>▶ Check that there is no air in the system (vent the system if necessary).</li> <li>▶ Check that the water pressure is sufficient on the pressure gauge. The water pressure must be &gt;1 bar (cold water).</li> <li>▶ Check that the expansion tank is intact.</li> <li>▶ Check that the resistance characteristic of the water circuit is not too high for the pump.</li> </ul>
	The volume of water in the installation is insufficient.	▶ Check that the volume of water in the installation is greater than the minimum required value (→ Chapter 7, page 46).
	Unit in alarm	<ul style="list-style-type: none"> <li>▶ Check alarm code. A list of the alarms can be found in Chapter 11.4, page 126.</li> <li>▶ Report the problem to your local serviceman.</li> </ul>
The unit is switched on but the compressor does not start (for room heating or domestic hot water heating)	The unit should start outside its operating range (the water temperature is too low).	<p>If the water temperature is low, the system first uses the backup heater to reach the minimum required temperature (12 °C).</p> <ul style="list-style-type: none"> <li>▶ Check that the power supply to the backup heater is correct.</li> <li>▶ Check that the backup heater's thermal fuse is closed.</li> <li>▶ Check that the backup heater's thermal protection has not tripped.</li> <li>▶ Check that the backup heater's contactors are intact.</li> <li>▶ Be prepared with a backup heater if you think that cold starts may be frequent in these conditions (in case of long winter system shutdowns).</li> </ul>

Problems	Possible causes	Corrective action
The pump is noisy (cavitation)	The system contains air.	▶ Vent the air.
	Insufficient pressure of water entering the pump	▶ Check that the water pressure is sufficient on the pressure gauge. The water pressure must be >1 bar (cold water). ▶ Check that the pressure gauge is working properly. ▶ Check that the expansion tank is intact. ▶ Check that the expansion tank precharge is set correctly (→ Chapter 7, page 46).
The water pressure relief valve opens	Expansion tank is faulty.	▶ Replace the expansion tank.
	The water filling pressure in the installation is greater than 0.30 MPa.	▶ Check that the water filling pressure in the installation is approx. 0.15...0.18 MPa (→ Chapter 7, page 46). ▶ Checking the volume of water and precharge of the expansion tank. ▶ If the pressure is higher, partially empty the circuit until the optimum range is reached.
The water pressure relief valve is leaking	The water pressure relief valve outlet is obstructed.	▶ Check that the pressure relief valve is working properly by turning the red knob on the valve anticlockwise: <ul style="list-style-type: none"> <li>– If you do not hear a click, contact your local dealer.</li> <li>– if water continues to leak out of the unit, close the shut-off valves at the water inlet and outlet and contact your local dealer.</li> </ul>
The heat pump in DHW mode stops working but the setpoint is not reached, the room heating requires heat but the unit remains in DHW mode.	Coil surface in the tank is not large enough.	▶ Set dT1s5 to 20 and set t_DHWHP_RESTRICT to the minimum value. ▶ Set dT1SH to 2. ▶ Enable TBH, TBH must be controlled by the unit. ▶ If AHS (boiler) is available, enable it from the dip-switch also for DHW production. ▶ If TBH and AHS are not available, try changing the position of the T5 probe.
	TBH or AHS not available	The heat pump will remain in DHW mode until either t_DHWHP_MAX or the setpoint is reached. ▶ Add TBH or AHS for DHW mode. ▶ TBH and AHS must be controlled by the unit.
Room heating is insufficient when the outdoor temperature is low.	The backup heater does not start.	▶ Check that the <b>OTHER HEATING SOURCE/ BACKUP HEATER</b> option is enabled (→ Chapter 9.2.7, page 84 and Chapter 8.8, page 65). ▶ Check that the backup heater's thermal protection has not tripped. ▶ Check that the booster heater is not operating; the backup heater and booster heater cannot operate simultaneously. ▶ Check fuses or safety thermostats in the case of an external backup heater and, if necessary, replace them after ascertaining the reason for the intervention.
	Too much heat pump capacity is used to heat domestic hot water (only for installations with domestic hot water storage tank).	▶ Check that parameters t_DHWHP_MAX and t_DHWHP_RESTRICT are configured correctly. ▶ Check that the DHW PRIORITY function on the user interface is disabled. ▶ Enable parameter T4_TBH_ON on the user interface/ <b>FOR SERVICEMAN</b> menu to start the booster heater for heating domestic hot water.
It is not possible to switch immediately from heating mode to DHW mode.	The tank volume is too small and the position of the water temperature probe is not high enough.	▶ Set dT1s5 to 20 and set t_DHWHP_RESTRICT to the minimum value. ▶ Set dT1SH to 2. ▶ Enable TBH, TBH must be controlled by the unit. ▶ If AHS (boiler) is available, switch on the boiler first, if the demand for the heat pump switched on is full, the heat pump will switch on. ▶ If TBH and AHS are not available, try changing the position of the T5 probe.

Problems	Possible causes	Corrective action
It is not possible to switch immediately from DHW mode to heating mode.	Heat exchanger for room heating is not large enough.	<ul style="list-style-type: none"> <li>▶ Set t_DHWHP_MAX to the minimum value, suggested value is 60min.</li> <li>▶ If the circulation pump outside the unit is not controlled by the unit, try connecting it to the unit.</li> <li>▶ Add a 3-way valve to the inlet of the fan coil unit to ensure sufficient water flow.</li> </ul>
	The heating load in the room is reduced.	▶ Normal, no need for heating.
	The disinfect function is enabled but without TBH.	<ul style="list-style-type: none"> <li>▶ Disable the disinfect function.</li> <li>▶ Add TBH or AHS for DHW mode.</li> </ul>
	Manual activation of the FAST WATER function, after the hot water fulfils the requirements, the heat pump does not switch to air conditioning mode.	▶ Manual activation of the FAST WATER function.
	The room temperature is low, AHS does not start.	<ul style="list-style-type: none"> <li>▶ Set T4DHWMIN, suggested value <math>\geq -5</math> °C.</li> <li>▶ Set T4_TBH_ON, suggested value <math>\geq 5</math> °C.</li> </ul>
	DHW Priority	▶ If AHS or IBH are present, when the unit is not operating, IBH or AHS must operate in DHW mode until the water temperature reaches the set temperature before switching to heating mode.

Table 56 General problems

### 13.2 Error codes

When a safety device is activated, an error code is displayed on the user interface. The following table contains a list of possible errors and their corrective actions.

To reset the safety device:

- ▶ Switch the unit off and on again.

If the reset procedure fails:

- ▶ Contact your local dealer.

Error code	Malfunctioning or protection	Cause of the problem and corrective action
CO	multiple units configured as master in the master - slave network	▶ Configure only one unit as master.
E0	Flow switch error (E8 displayed 3 times; to be seen together with E8).	<ul style="list-style-type: none"> <li>▶ The electric circuit has short-circuited or is open. Reconnect the wires correctly.</li> <li>▶ The water flow-rate is insufficient.</li> <li>▶ The flow switch is faulty. The switch opens or closes continuously. Replace the flow switch.</li> <li>▶ The system pressure losses are too high for the head of the unit's circulator. Overhaul the system.</li> </ul>
E1	Phase sequence error (only for three-phase units).	<ul style="list-style-type: none"> <li>▶ Check that the power cables are firmly connected to avoid phase losses.</li> <li>▶ Check the sequence of the power cables, change the sequence of any pair of the three power cables.</li> </ul>
E2	Communication error between the user interface and the main hydraulic module control board.	<ul style="list-style-type: none"> <li>▶ There is no connection between the wired control and the unit. Connect the wires.</li> <li>▶ The sequence of the communication wires is not correct. Reconnect the wires in the correct sequence.</li> <li>▶ There may be a strong magnetic field or electrical interference, e.g. from lifts, large transformers, etc. Add a barrier to protect the unit or move it to another location.</li> <li>▶ Check for possible interference from power cables along the path of the control cable.</li> </ul>
E3	Error of the backup heater's heat exchanger outlet T1 temperature sensor.	<ul style="list-style-type: none"> <li>▶ The T1 sensor connector is loose. Reconnect it.</li> <li>▶ The T1 sensor connector is wet or contains water. Expel the water and dry the connector. Apply a waterproof adhesive.</li> <li>▶ T1 sensor error, replace with a new sensor.</li> </ul>
E4	T5 DHW temperature sensor error	<ul style="list-style-type: none"> <li>▶ The T5 sensor connector is loose. Reconnect it.</li> <li>▶ The T5 sensor connector is wet or contains water. Expel the water and dry the connector. Apply a waterproof adhesive.</li> <li>▶ T5 sensor error, replace with a new sensor.</li> </ul>
E5	Error of the finned coil outlet T3 refrigerant temperature sensor in cooling mode.	<ul style="list-style-type: none"> <li>▶ The T3 sensor connector is loose. Reconnect it.</li> <li>▶ The T3 sensor connector is wet or contains water. Expel the water and dry the connector. Apply a waterproof adhesive.</li> <li>▶ T3 sensor error, replace with a new sensor.</li> </ul>
E6	T4 room temperature sensor error.	<ul style="list-style-type: none"> <li>▶ The T4 sensor connector is loose. Reconnect it.</li> <li>▶ The T4 sensor connector is wet or contains water. Expel the water and dry the connector. Apply a waterproof adhesive.</li> <li>▶ T4 sensor error, replace with a new sensor.</li> </ul>

Error code	Malfunctioning or protection	Cause of the problem and corrective action
E7	Tbt1 sensor error.	<ul style="list-style-type: none"> <li>▶ The Tbt1 sensor connector is loose. Reconnect it.</li> <li>▶ The Tbt1 sensor connector is wet or contains water. Expel the water and dry the connector. Apply a waterproof adhesive.</li> <li>▶ Tbt1 sensor error, replace it.</li> </ul>
E8	Water flow-rate error.	<ul style="list-style-type: none"> <li>▶ Check that all shut-off valves in the water circuit are fully open.</li> <li>▶ Check that the water filter is clean (→ Chapter 7.7, page 52).</li> <li>▶ Check that there is no air in the system; vent the system if necessary.</li> <li>▶ Check that the water pressure is sufficient on the pressure gauge. The water pressure must be &gt;1 bar.</li> <li>▶ Check that the pump speed is set to the maximum value.</li> <li>▶ Check that the expansion tank is intact.</li> <li>▶ Check that the resistance characteristic of the water circuit is not too high for the pump.</li> <li>▶ If this error occurs during the defrosting function (during room heating or domestic hot water heating), check that the power supply to the backup heater is connected correctly and the fuses have not blown.</li> <li>▶ Check that the pump fuse and the PCB fuse have not blown.</li> </ul>
E9	Th suction pipe sensor error.	<ul style="list-style-type: none"> <li>▶ The Th sensor connector is loose. Reconnect it.</li> <li>▶ The Th sensor connector is wet or contains water. Expel the water and dry the connector. Apply a waterproof adhesive.</li> <li>▶ Th sensor error, replace it.</li> </ul>
EA	Tp discharge temperature sensor error.	<ul style="list-style-type: none"> <li>▶ The Tp sensor connector is loose. Reconnect it.</li> <li>▶ The Tp sensor connector is wet or contains water. Expel the water and dry the connector. Apply a waterproof adhesive.</li> <li>▶ Tp sensor error, replace it.</li> </ul>
Eb	Solar panel sensor error (T <sub>solar</sub> ).	<ul style="list-style-type: none"> <li>▶ The sensor connector is loose. Reconnect it.</li> <li>▶ The sensor connector is wet or contains water. Expel the water and dry the connector. Apply a waterproof adhesive.</li> <li>▶ Sensor error, replace it.</li> </ul>
Ed	Tw <sub>in</sub> entering water temperature sensor error.	<ul style="list-style-type: none"> <li>▶ The Tw<sub>in</sub> sensor connector is loose. Reconnect it.</li> <li>▶ The Tw<sub>in</sub> sensor connector is wet or contains water. Expel the water and dry the connector. Apply a waterproof adhesive.</li> <li>▶ Tw<sub>in</sub> sensor error, replace it.</li> </ul>
EE	EEPROM control board main hydraulic module control board failure.	<ul style="list-style-type: none"> <li>▶ EEprom parameter error, rewrite EEprom data.</li> <li>▶ EEprom chips are faulty, replace with a new EEprom.</li> <li>▶ Main hydraulic module control board is faulty, replace with a new PCB.</li> </ul>
bH	PED board error.	<ul style="list-style-type: none"> <li>▶ Switch off the power and switch on again after 5 minutes; check if everything is OK.</li> <li>▶ Replace the board, switch on again and check if everything is OK.</li> <li>▶ Replace the IPM module board.</li> </ul>
H0	Communication error between the main PCB B control board and the main hydraulic module control board.	<ul style="list-style-type: none"> <li>▶ The cable is disconnected between the main PCB B control board and the main hydraulic module control board. Connect the cable.</li> <li>▶ The sequence of the communication wires is not correct. Reconnect the wires in the correct sequence.</li> <li>▶ If there is a high magnetic field or high-power interference, e.g. lifts, large power transformers, etc. Add a barrier to protect the unit or move the unit to another location.</li> </ul>
H1	Communication error between PCB A inverter module and the main PCB B control board.	<ul style="list-style-type: none"> <li>▶ Check that the power supply is connected to the PCB and secondary board. Check whether the PCB indicator light is on or off. If it is switched off, reconnect the power cables.</li> <li>▶ If it is switched on, check the electrical connections between the main PCB and the secondary PCB. If the wire is loose or broken, reconnect it or replace it.</li> <li>▶ Replace the main PCB and the secondary board.</li> </ul>
H2	Error of the plate heat exchanger inlet temperature sensor (T2) on the refrigerant side in cooling mode.	<ul style="list-style-type: none"> <li>▶ The T2 sensor connector is loose. Reconnect it.</li> <li>▶ The T2 sensor connector is wet or contains water. Expel the water and dry the connector. Apply a waterproof adhesive.</li> <li>▶ T2 sensor error, replace with a new sensor.</li> </ul>
H3	Error of the heat exchanger outlet temperature sensor (T2B) on the refrigerant side in cooling mode.	<ul style="list-style-type: none"> <li>▶ The T2B sensor connector is loose. Reconnect it.</li> <li>▶ The T2B sensor connector is wet or contains water. Expel the water and dry the connector. Apply a waterproof adhesive.</li> <li>▶ T2B sensor error, replace with a new sensor.</li> </ul>
H4	Three P6 protection activations.	<ul style="list-style-type: none"> <li>▶ See P6.</li> </ul>
H5	Ta internal temperature sensor error.	<ul style="list-style-type: none"> <li>▶ Set the Ta sensor on the interface.</li> <li>▶ If the Ta sensor is faulty, replace the sensor or interface.</li> </ul>

Error code	Malfunctioning or protection	Cause of the problem and corrective action
H6	DC fan error.	<ul style="list-style-type: none"> <li>▶ The fan is exposed to a strong wind that causes it to operate in the opposite direction. Change the direction of operation of the unit or provide a guard to protect it from strong air currents.</li> <li>▶ The fan motor is faulty, replace it.</li> </ul>
H7	Main circuit voltage fault.	<ul style="list-style-type: none"> <li>▶ Check that the power supply values are within the available range.</li> <li>▶ The unit has been switched on and off several times at close intervals. Keep the unit switched off for at least 3 minutes before switching it on again.</li> <li>▶ Faulty circuit in the main control board. Replace the main PCB.</li> </ul>
H8	Pressure sensor error.	<ul style="list-style-type: none"> <li>▶ The pressure sensor connector is loose. Reconnect it.</li> <li>▶ The pressure sensor is faulty. Replace it.</li> </ul>
H9	Tw2 sensor error.	<ul style="list-style-type: none"> <li>▶ The sensor connector is loose. Reconnect it.</li> <li>▶ The sensor connector is wet or contains water. Expel the water and dry the connector. Apply a waterproof adhesive.</li> <li>▶ Sensor error, replace it with a new sensor.</li> </ul>
HA	Error of the TW_out leaving water temperature sensor of the plate heat exchanger.	<ul style="list-style-type: none"> <li>▶ The TW_out sensor connector is loose. Reconnect it.</li> <li>▶ The TW_out sensor connector is wet or contains water. Expel the water and dry the connector. Apply a waterproof adhesive.</li> <li>▶ The TW_out sensor is faulty. Replace it.</li> </ul>
Hb	PP protection trips 3 times and Tw_out < 7 °C.	<ul style="list-style-type: none"> <li>▶ See PP.</li> </ul>
Hd	Communication error between master and slave units.	<ul style="list-style-type: none"> <li>▶ Wrong address.</li> <li>▶ Incorrect wiring.</li> <li>▶ Check board fuse.</li> <li>▶ H1-H2 wiring.</li> </ul>
HE	Communication error between main board and thermostat.	<p>The outdoor temperature is very high (above 30°C) but the unit is still operating in Heating mode.</p> <ul style="list-style-type: none"> <li>▶ Disable the Heating mode when the room temperature exceeds 30 °C.</li> </ul>
HF	Inverter module EEprom error.	<ul style="list-style-type: none"> <li>▶ The EEprom parameter is set incorrectly, rewrite the EEprom data.</li> <li>▶ The EEprom chip is faulty, replace it.</li> <li>▶ The main module is faulty, replace it.</li> </ul>
HH	H6 displayed 10 times in 2 hours.	<ul style="list-style-type: none"> <li>▶ See H6.</li> </ul>
HL	PFC module fault.	<ul style="list-style-type: none"> <li>▶ Contact distributor.</li> </ul>
HP	Low pressure protection (Pe < 0.6) tripped 3 times in one hour.	<ul style="list-style-type: none"> <li>▶ See P0.</li> </ul>
P0	Low pressure protection.	<ul style="list-style-type: none"> <li>▶ There is no refrigerant in the system. Charge with refrigerant to the required volume.</li> <li>▶ In heating or hot water mode, the external heat exchanger is dirty or clogged. Clean the heat exchanger.</li> <li>▶ The water flow is low in cooling mode.</li> <li>▶ The electrical expansion valve is blocked or the winding connector is loose. Tap the valve body and insert/remove the connector several times to check that the valve is working properly. Install the winding in the correct position.</li> </ul>
P1	High pressure protection.	<p>Heating mode, domestic hot water mode:</p> <ul style="list-style-type: none"> <li>▶ The water flow-rate is low; the water temperature is high, check if there is air in the system. Expel the air.</li> <li>▶ The water pressure is less than 0.1 Mpa, fill with water to increase the pressure to 0.15-0.18 Mpa.</li> <li>▶ Increase the volume of refrigerant. Top up the refrigerant to the required volume.</li> <li>▶ The electrical expansion valve is blocked or the winding connector is loose. Tap the valve body and insert/remove the connector several times to check that the valve is working properly. Install the winding in the correct position.</li> </ul> <p>Domestic hot water mode:</p> <ul style="list-style-type: none"> <li>▶ The heat exchanger storage tank has an insufficient area. Increase parameter DT1s5 to 20 °C (DT DHW). <b>Caution:</b> This will lower the maximum setpoint that the unit can fulfil.</li> </ul> <p>Cooling mode:</p> <ul style="list-style-type: none"> <li>▶ The external heat exchanger cover is attached. Remove it.</li> <li>▶ The external heat exchanger is dirty or its surface is obstructed. Clean the heat exchanger or remove the obstruction.</li> <li>▶ Ensure that functional spaces and proper ventilation are respected.</li> <li>▶ Check for ventilation faults during operation.</li> </ul>

Error code	Malfunctioning or protection	Cause of the problem and corrective action
P3	Compressor over current protection.	<ul style="list-style-type: none"> <li>▶ See P1.</li> <li>▶ The unit's power supply voltage is low, increase it to the required value.</li> </ul>
P4	Protection for high discharge temperature.	<ul style="list-style-type: none"> <li>▶ See P1.</li> <li>▶ The volume of refrigerant in the system is insufficient, charge with the required volume.</li> <li>▶ The TW_out temperature sensor is loose. Reconnect it.</li> <li>▶ The T1 temperature sensor is loose. Reconnect it.</li> <li>▶ The T5 temperature sensor is loose. Reconnect it.</li> </ul>
P5	Protection against high temperature difference between entering and leaving water of the plate heat exchanger.	<ul style="list-style-type: none"> <li>▶ Check that all shut-off valves in the water circuit are fully open.</li> <li>▶ Check that the water filter is clean (→ Chapter 7.7, page 52).</li> <li>▶ Check that there is no air in the system (vent the system if necessary).</li> <li>▶ Check that the water pressure is sufficient on the pressure gauge. The water pressure must be &gt;1 bar (cold water).</li> <li>▶ Check that the pump speed is set to the maximum value.</li> <li>▶ Check that the expansion tank is intact.</li> <li>▶ Check that the characteristic of the water circuit is not too high for the pump (→ "START-UP AND CONFIGURATION - Pump speed control").</li> </ul>
P6	Module protection.	<ul style="list-style-type: none"> <li>▶ The unit's power supply voltage is low, increase it to the required value.</li> <li>▶ The space between the units is too narrow for heat exchange. Increase the space between units.</li> <li>▶ The heat exchanger is dirty or its surface is obstructed. Clean the heat exchanger or remove the obstruction.</li> <li>▶ The fan is not working. The fan motor is faulty, replace the fan or the motor.</li> <li>▶ Increase the volume of refrigerant. Top up the refrigerant to the required volume.</li> <li>▶ The water flow-rate is low, there is air in the system or the pump head is not sufficient. Expel the air and reset the pump.</li> <li>▶ The leaving water temperature sensor is loose or faulty, reconnect it or replace it.</li> <li>▶ The domestic hot water storage tank has coils that are not suitable for the power to be dissipated.</li> <li>▶ The wires or screws on the module are loose. Reconnect the wires and screws.</li> <li>▶ The heat-conducting adhesive is dry or detached. Add heat-conducting adhesive.</li> <li>▶ The wire connector is loose or detached. Reconnect the wire.</li> <li>▶ The control board is defective, replace it.</li> <li>▶ If the control system is working properly, it means that the compressor is faulty.</li> </ul>
P9	Fan protection.	<ul style="list-style-type: none"> <li>▶ Contact the Distributor.</li> </ul>
Pd	Protection for high refrigerant outlet temperature in the finned coil in cooling mode.	<ul style="list-style-type: none"> <li>▶ The heat exchanger cover is attached.</li> <li>▶ The heat exchanger is dirty or its surface is obstructed.</li> <li>▶ The space around the unit is not sufficient for heat exchange.</li> <li>▶ Review the installation.</li> <li>▶ The fan motor is faulty.</li> </ul>
Pb	Antifreeze protection.	The unit will automatically return to normal operation.
PP	The inlet water temperature is higher than the outlet water temperature in heating mode.	<ul style="list-style-type: none"> <li>▶ The inlet/outlet water sensor connector is loose.</li> <li>▶ The inlet sensor (TW_in) or outlet sensor (TW_out) is faulty.</li> <li>▶ The 4-way valve is blocked. Restart the unit to make the valve change direction.</li> <li>▶ The 4-way valve is faulty.</li> </ul>
F1	DC generatrix voltage too low.	<ul style="list-style-type: none"> <li>▶ Check power supply.</li> <li>▶ If the power supply is OK, check if the LED light is OK, check the PN voltage, if it is 380 V, the problem is with the main board. If the light is off, disconnect the power supply, check the IGBT, check the diodes, if the voltage is not correct, the inverter board is damaged, replace it.</li> <li>▶ If the IGBT is OK, which means the inverter board is OK, the rectifier bridge of the power module is not correct, check the bridge. Same method as for the IGBT, disconnect the power supply, check whether the diodes are damaged or not.</li> <li>▶ Usually if F1 trips when the compressor starts, the reason is possibly the motherboard. If F1 trips when the fan starts, it may be due to the inverter board.</li> </ul>

Error code	Malfunctioning or protection	Cause of the problem and corrective action
L0	Compressor inverter module fault.	<ul style="list-style-type: none"> <li>▶ Check the following parts:                             <ul style="list-style-type: none"> <li>– compressor working pressures</li> <li>– compressor winding heaters</li> <li>– U V W sequence between inverter board and compressor</li> <li>– L1 L2 L3 sequence between inverter board and filter board</li> <li>– inverter board</li> </ul> </li> </ul>
L1	Low voltage BUS protection of the inverter module.	
L2	High voltage BUS protection of the inverter module.	
L4	MCE protection.	
L5	Speed 0 protection.	
L7	Phase sequence error.	
L8	Compressor frequency variation greater than 15 Hz in 1 sec.	
L9	Compressor frequency difference to target greater than 15 Hz.	

Table 57 Error codes

## 14 Environmental protection and disposal

Environmental protection is a fundamental corporate strategy of the Bosch Group.

The quality of our products, their economy and environmental safety are all of equal importance to us and all environmental protection legislation and regulations are strictly observed.

We use the best possible technology and materials for protecting the environment taking account of economic considerations.

### Packaging

Where packaging is concerned, we participate in country-specific recycling processes that ensure optimum recycling.

All of our packaging materials are environmentally compatible and can be recycled.

### Old electrical and electronic appliances



This symbol means that the product must not be disposed of with other waste, and instead must be taken to the waste collection points for treatment, collection, recycling and disposal.

The symbol is valid in countries where waste electrical and electronic equipment regulations apply, e.g. "(UK) Waste Electrical and Electronic Equipment Regulations 2013 (as amended)". These regulations define the framework for the return and recycling of old electronic appliances that apply in each country.

As electronic devices may contain hazardous substances, it needs to be recycled responsibly in order to minimize any potential harm to the environment and human health. Furthermore, recycling of electronic scrap helps preserve natural resources.

For additional information on the environmentally compatible disposal of old electrical and electronic appliances, please contact the relevant local authorities, your household waste disposal service or the retailer where you purchased the product.

You can find more information here:

[www.bosch-homecomfortgroup.com/en/company/legal-topics/weee/](http://www.bosch-homecomfortgroup.com/en/company/legal-topics/weee/)

analyze the distribution of our products and to provide individualized information and offers related to the product (art. 6 (1) sentence 1 (f) GDPR / UK GDPR). To provide services such as sales and marketing services, contract management, payment handling, programming, data hosting and hotline services we can commission and transfer data to external service providers and/or Bosch affiliated enterprises. In some cases, but only if appropriate data protection is ensured, personal data might be transferred to recipients located outside of the European Economic Area and the United Kingdom. Further information are provided on request. You can contact our Data Protection Officer under: Data Protection Officer, Information Security and Privacy (C/ISP), Robert Bosch GmbH, Postfach 30 02 20, 70442 Stuttgart, GERMANY.

You have the right to object, on grounds relating to your particular situation or where personal data are processed for direct marketing purposes, at any time to processing of your personal data which is based on art. 6 (1) sentence 1 (f) GDPR / UK GDPR. To exercise your rights, please contact us via [privacy.ttgb@bosch.com](mailto:privacy.ttgb@bosch.com) To find further information, please follow the QR-Code.

## 15 Data Protection Notice



We, **Bosch Thermotechnology Ltd., Cotswold Way, Warndon, Worcester WR4 9SW, United Kingdom** process product and installation information, technical and connection data, communication data, product registration and client history data to provide product functionality (art. 6 (1) sentence 1 (b) GDPR

/ UK GDPR), to fulfil our duty of product surveillance and for product safety and security reasons (art. 6 (1) sentence 1 (f) GDPR / UK GDPR), to safeguard our rights in connection with warranty and product registration questions (art. 6 (1) sentence 1 (f) GDPR / UK GDPR) and to





Bosch Thermotechnik GmbH  
Junkersstrasse 20-24  
73249 Wernau, Germany  
[www.bosch-homecomfortgroup.com](http://www.bosch-homecomfortgroup.com)

GB Importer:  
Bosch Thermotechnology Ltd.  
Cotswold Way, Warndon  
Worcester WR4 9SW, United Kingdom