



ENVIRO
BUILD

HYPERION

D E C K I N G



PIONEER



FRONTIER

ENVIROBUILD.COM



+44 (0) 208 088 4888

FSC Trademark Licence: FSC® C007915



THE COMPLETE COMPOSITE DECKING SYSTEM

Hyperion composite products are the ideal solution for any outdoor living space. The anti-slip boards do not rot, warp or splinter and never need treating, giving you a low maintenance and safe deck for years to come, all backed by industry leading warranties.

The FSC® 100% certified decking is secured with innovative hidden fastenings and complemented by a range of finishing accessories giving a perfect contemporary finish. The decking sub-structure comprises maintenance free recycled plastic bearers and adjustable pedestal supports, giving options to install on all types of flat roofs, balconies or gardens.



DECKING BOARDS

PAGE 4



ACCESSORIES

PAGE 8



SUPPORT SYSTEMS

PAGE 9

COMPOSITE BENEFITS

Hyperion® wood-polymer composite decking (WPC Decking) is made from 60% recycled wood (FSC® 100% certified) and 30% recycled High Density Polyethylene with the final 10% environmentally gentle bonding agent, additives and tint. It gives a host of advantages over traditional timber and has become the expected standard for commercial balconies and terraces.



**LOW MAINTENANCE,
NEVER TREAT OR STAIN**



**DOES NOT ROT,
WARP OR SPLINTER**



**LONG LASTING RANGE
OF LOOKS**



**QUICK & EASY
INSTALLATION**



**LARGE STOCKS WITH
NATIONWIDE DELIVERY**



**DESIGN SUPPORT
FROM EXPERT TEAM**









**UP TO 25 YEARS
WARRANTY**



**HIGHLY RATED
NON-SLIP DECKING**





**FREE SAME
DAY QUOTATIONS**

FEATURE	TIMBER	PIONEER	FRONTIER
 Commercial Warranty	-	10 Years	15 Years
 Residential Warranty	-	15 Years	25 Years
 Anti-slip	•••	•••••	•••••
 Weathering	•	•••	•••••
 Anti-stain	•	•••	•••••
 Anti-splinter	•	•••••	•••••
 Easy to clean	••	••••	•••••

HYPERION

DECKING

PROFILE SPECIFICATIONS

Range	Profile (mm)	Length Options	Support Spacing	Board Type	Surface Finish	Slip Resistance	Fire Rating	Weight (kg/m)	Water Absorption	Recycled Content	Quantity per m ²
 <p>PIONEER</p>	145 x 21	2200 / 4000mm	300mm	Hollow Structure	Reversible: Grooved one side, softwood grain on reverse	Low potential for slip; Wet: 40; Dry: 52	C-fl	2.4kg	1.04%	90%	6.62m
 <p>FRONTIER</p>	143 x 22	4000mm	400mm	Solid Structure	Reversible: Hardwood grain one side, softwood grain on reverse	Moderate to low potential for slip; Wet: 37; Dry: 50	-	3.4kg	0.88%	90%	6.71m

PIONEER BOARD

Our best selling anti-slip board range is perfect for balcony and terrace areas. This durable and lightweight board comes with a warranty against warping and splitting, guaranteeing you a perfect finish.



- 15 year residential, 10 year commercial limited warranty
- Low slip potential
- Reversible finish, choose between softwood grain and traditional grooves
- Made from FSC® 100% Certified recycled wood and recycled HDPE
- Hidden and secure fastening system



WALNUT



OAK

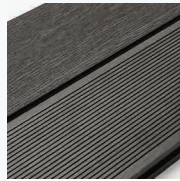

GRANITE

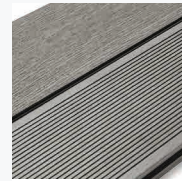

STONE

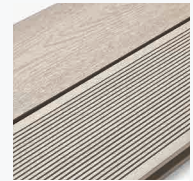

SILVER BIRCH

FRONTIER BOARD

The ultra low maintenance and anti-slip Frontier range uses a solid design to give greater durability in high use commercial locations. Engineered almost entirely from recycled material that does not split, splinter or rot you save year after year over standard wood products. Choose between a reversible hardwood or softwood finish.



- 25 year residential, 15 year commercial limited warranty
- Full fade and stain warranty protection, with low slip potential
- Made from FSC® 100% Certified recycled wood and recycled HDPE
- Hidden and secure fastening system



TEAK



IROKO



SLATE



MARBLE

SIMPLE INSTALLATION

Hyperion Decking boards are installed with a quick and easy hidden fastener system, leaving your deck with a flush screw-less finish.

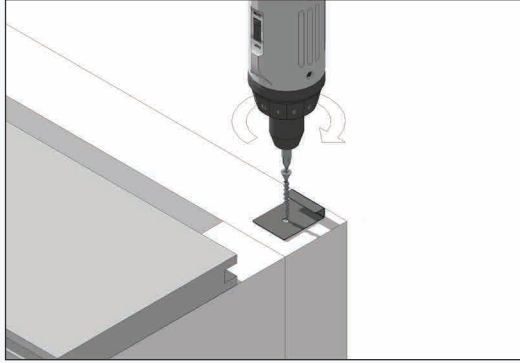

① Fix starter clips to the outer edge of your deck

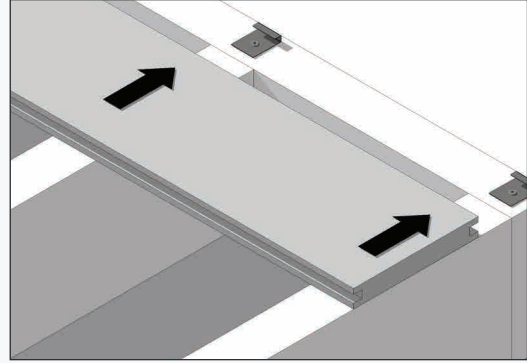

② Slide the first board into the starter fasteners

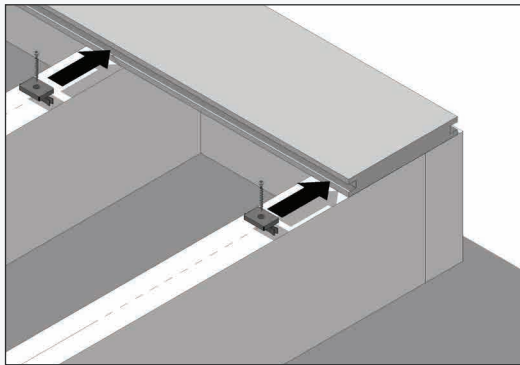

③ Place the hidden fasteners into the board edge

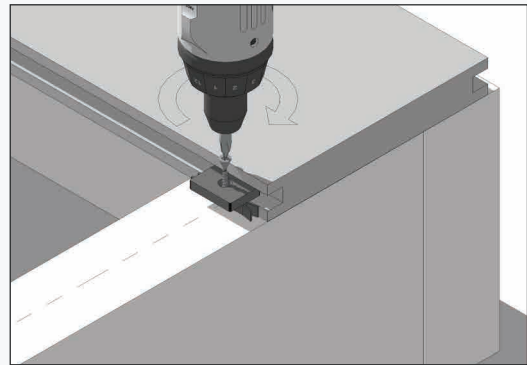

④ Screw down lightly to the deck bearer

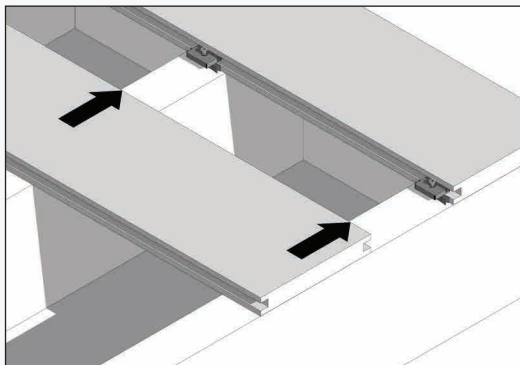

⑤ Slide and tap the next board in place

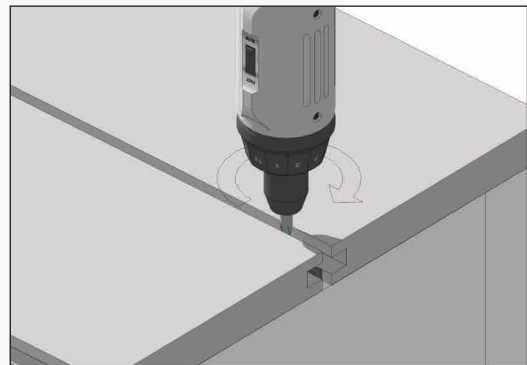

⑥ Tighten the hidden fasteners to secure the board

OUR SERVICE

If you need help at any point from concept to installation, from small residential to large commercial projects, our expert team offer a free design and build quotation service, and can advise the best use of our products.

With the ever increasing requirement for sustainable building materials, Hyperion Decking is the perfect choice for your space.



**FREE SAME DAY
QUOTATION SERVICE**



**EXPERT TEAM ON HAND TO
HELP WITH YOUR PROJECT**



**FULL TECHNICAL
SPECIFICATIONS ON PRODUCTS**



**BESPOKE DELIVERY SERVICES,
INCLUDING NEXT DAY**







HYPERION DECKING ACCESSORIES

Enhance the beauty and functionality of your space with innovative and environmentally friendly Hyperion Decking accessories. Designed with large projects in mind, the versatile collection provides solutions for every installation.



ACCESSORY SPECIFICATIONS

Accessory	Product	Profile	Size Options	Range	Colour	Water Absorption	Recycled Content
	Pioneer Fascia	72 x 12	2500mm	Pioneer	Walnut, Stone, Oak, Granite, Silver Birch	1.04%	90%
	Pioneer Corner Nosing Trim	54 x 40	2500mm	Pioneer	Walnut, Stone, Oak, Granite, Silver Birch	1.04%	90%
	Pioneer Edge Board	54 x 54	2500mm	Pioneer	Walnut, Stone, Oak, Granite, Silver Birch	1.04%	90%
	Frontier Fascia Boarding	140 x 12	2200mm	Frontier	Iroko, Teak, Slate, Marble	0.88%	90%
	Frontier Bullnose Edging	143 x 22	4000mm	Frontier	Iroko, Teak, Slate, Marble	0.88%	90%

HIDDEN FASTENERS



6mm Hidden Fastener



3mm Hidden Fastener



Starter Fastener

Product	Size Options	Covering
6mm Hidden Fastener	Box of 100	5m ²
3mm Hidden Fastener	Box of 100	5m ²
Starter Fastener	Box of 50	~12.5m ²



MANTICORE



LUMBER

This environmentally friendly product is made in the UK from 100% recycled content and comes with a 10-year limited warranty. This maintenance free and moisture resistant recycled plastic timber alternative is perfect for balconies, terraces and gardens.

The easy to use material cuts and works just like wood without the long term maintenance costs, so you save every year over standard wood products.



LUMBER SPECIFICATIONS

	Product	Profile	Size Options	Support Spacing	Coefficient of Expansion	Water Absorption	Recycled Content	Quantity per m ²
	Low Profile Plastic Bearer	50 x 50	3100mm	500mm	0.016mm / m / °C	0.02%	100%	4m
	Plastic Joist	50 x 100	3400mm	750mm	0.016mm / m / °C	0.02%	100%	4m
	Large Plastic Joist	50 x 150	3400mm	1500mm	0.016mm / m / °C	0.02%	100%	4m
	Plastic Support Post	100 x 100	3400mm	-	0.016mm / m / °C	0.02%	100%	0.5m

Other profiles are available



MESA

S U P P O R T

DECKING PEDESTALS

MESA pedestals support loads of up to 1000kg with a 20 year limited warranty making them the most robust support in the market. With the height adjusted by a simple rotation of the head they can support heights ranging from 10mm to 595mm and beyond.



Accessories include joist cradles, slope correctors and rubber pads to protect roof membranes.

- Made from 90% recycled material
- 10 - 600mm height range
- 20 year limited warranty
- Pedestals can also be used for paving projects

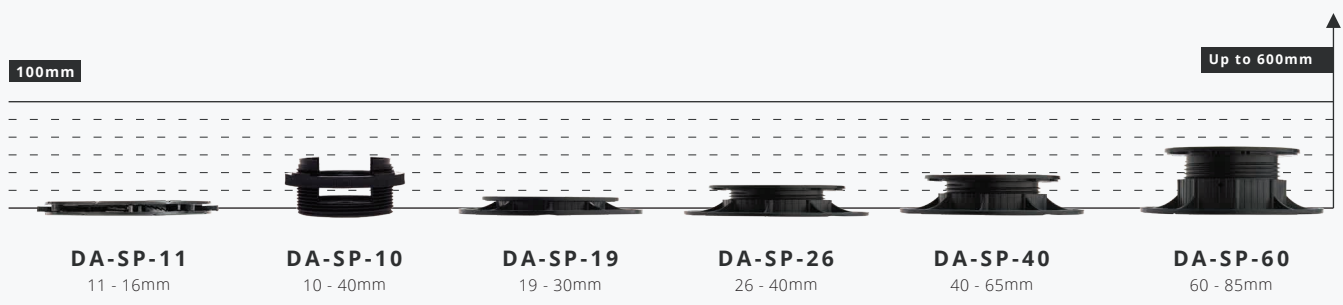
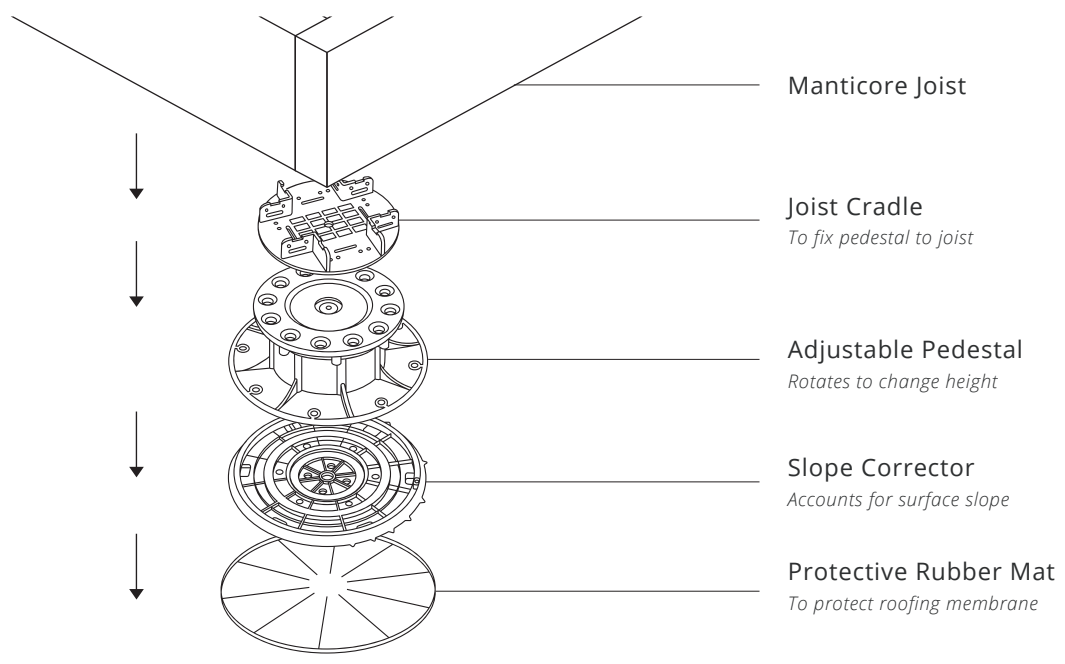

ADJUSTABLE DECKING RISER

With a height ranging from 10-40mm the MESA support adjustable pedestal is the perfect cost effective substructure for your project.

- Suitable for 47-50mm wide bearers
- Joist cradle and protective rubber pad incorporated
- Quick & simple to install
- Adjustable height by twisting the ring collar



A SIZE FOR ANY PROJECT

With a range spanning from 10 - 595mm, MESA provides the perfect foundation.

	Product	Profile Diameter (mm)	Size Options	Colour	Water Absorption	Recycled Content
	Adjustable Joist Support Pedestal	200	10-595mm	Black	0.00%	90%
	Support Pedestal Protective Rubber Pad	200	3mm	Black	0.00%	100%
	Slope Corrector	200	12mm	Black	0.00%	90%
	Joist Cradle	160	4mm	Black	0.00%	90%
	Adjustable Decking Riser	90	10-40mm	Black	0.00%	90%



ADDITIONAL HYPERION RANGES

Complete your project with Hyperion Pioneer Cladding and Fencing.

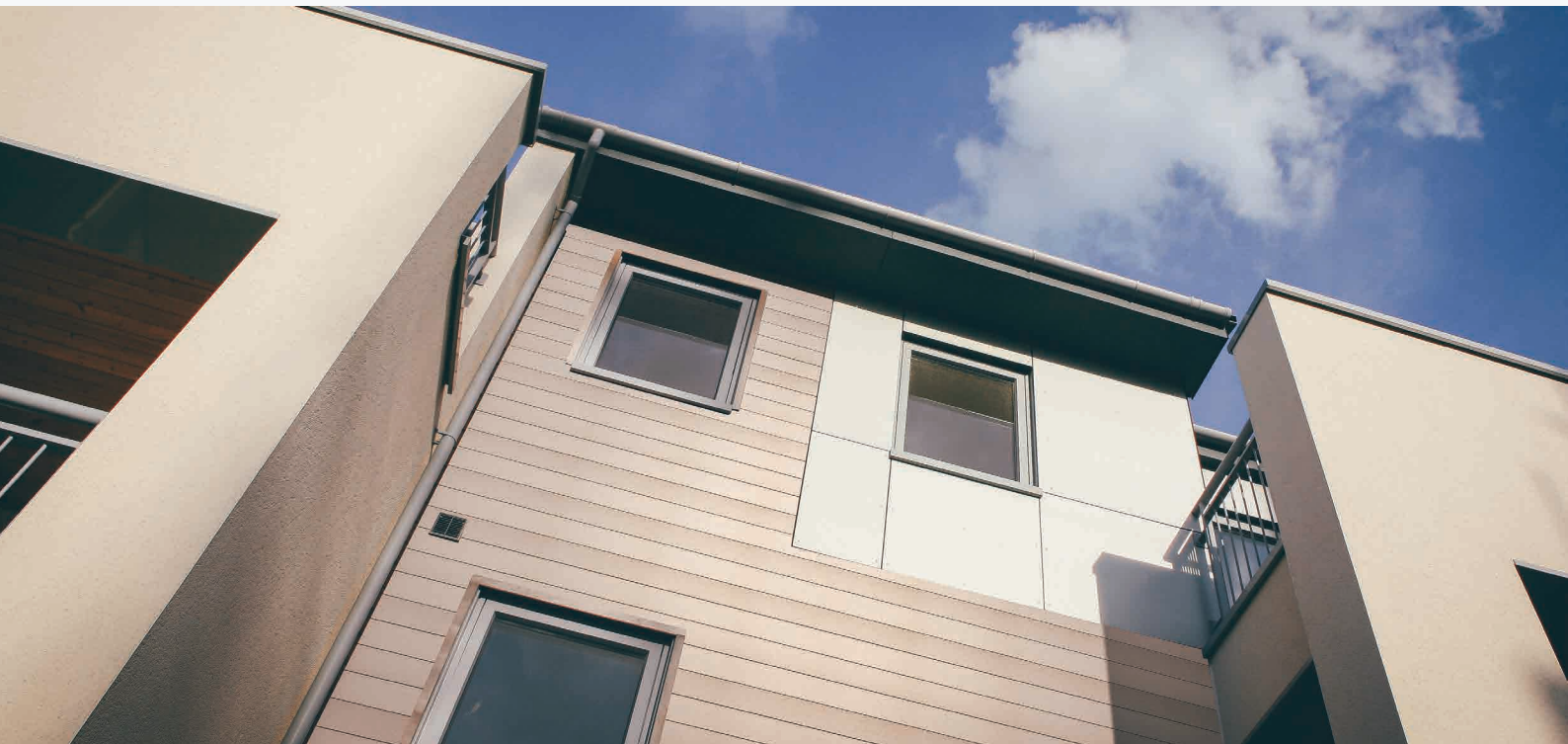

HYPERION CLADDING

Made from the same recycled and FSC® 100% certified materials as the Hyperion Decking range, Hyperion Cladding is ultra-low maintenance and highly durable.

The non-toxic material can be fitted using standard woodworking tools making them fast and easy to install and safe to work with.

Available in fire-class B and D (EN 13501-1)

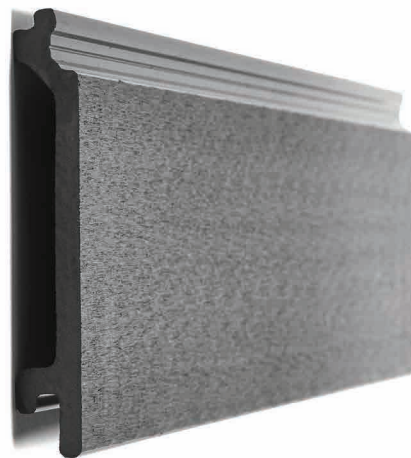

WALNUT



OAK

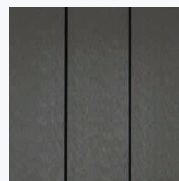

GRANITE



STONE

HYPERION FENCING

Hyperion® wood-polymer composite fencing is made from 60% bamboo (FSC® 100% Certified) and 40% recycled High Density Polyethylene, environmentally gentle bonding agent, additives and tint.

This low maintenance and solid solution is the perfect choice for any commercial terrace screening or residential fencing and comes with 15 year limited residential warranty.



WALNUT



OAK



GRANITE



STONE



OUR CLIENTS



OUR PROJECTS



CENTRE POINT



EBURY PLACE



COLINDALE

See more at www.envirobuild.com

Giving Back

LASTING BENEFIT
TO THE ENVIRONMENT

We donate 10% of our profits to sustainable causes. We are currently supporting the Rainforest Trust who work with local communities and governments to protect endangered rainforests and species.

It is our aim to ensure that our activities and products are carbon negative and we help create real long term solutions without simply 'greenwashing'.



RAINFOREST
TRUST®



ENVIRO
BUILD

HYPERION

D E C K I N G

ENVIROBUILD.COM



+44 (0) 208 088 4888

EnviroBuild Materials Ltd, 105 Sumner Street, London, SE1 9HZ