

January 2017

BRETT MARTIN
RAINWATER SYSTEMS

PRODUCT GUIDE

PRODUCT RANGE
INSTALLATION DETAILS

RAINWATER SYSTEMS

RAINWATER

P R O D U C T G U I D E



Plumbing & Drainage



Plumbing & Drainage

Brett Martin is a multi-site international organisation producing not only an extensive range of plastic Underground, Rainwater and Plumbing systems but also Europe's largest range of GRP, PVC, Polycarbonate and Acrylic rooflight sheet products.

Our reputation for excellence in product quality and technical service is founded on over 50 years manufacturing experience.



BRETT MARTIN
PLUMBING & DRAINAGE
MANUALS

RAINWATER

PRODUCT GUIDE

When selecting a rainwater system, you need to be sure of its pedigree, convinced of its ability to perform and confident of enduring quality.

The excellence of Rainwater Systems manufactured by Brett Martin Ltd is recognised by the achievement of BS EN ISO 9001:2008 registration of all of the company's four locations in the UK.

You can be confident that, as a BSI Registered Firm, our Quality Assurance programme guarantees that Brett Martin Rainwater Systems are first class products.



PRODUCT CATALOGUE

	Page		
INTRODUCTION	4	INSTALLATION	
PRODUCT & COLOUR RANGE	5	HANDLING	
RAINWATER SYSTEMS		STORAGE	
PROSTYLE 106mm PROFILED DOMESTIC SYSTEM	6-8	A TYPICAL RAINWATER SYSTEM	33
ROUNDSTYLE 112mm CLASSIC DOMESTIC SYSTEM	9-11	GUTTER INSTALLATION	34
SQUARESTYLE 114mm MODERN DOMESTIC SYSTEM	12-14	GUTTER SUPPORT SPACING	
DEEPSTYLE 115mm HIGH CAPACITY DOMESTIC SYSTEM	15-16	FITTING GUTTER	35
65mm SQUARE DOWNPIPE SYSTEM	17-18	DEEPSTYLE 170 ANGLE AND CLIP INSTALLATION	35
68mm ROUND DOWNPIPE SYSTEM	19-20	DOWNPIPE INSTALLATION	36
HIGH CAPACITY 160mm INDUSTRIAL SYSTEM	21-22	CONNECTION TO UNDERGROUND	
DEEPSTYLE 170 170mm INDUSTRIAL RAINWATER SYSTEM	23-24	DRAINAGE	
110mm, 160mm & 200mm INDUSTRIAL DOWNPIPE SYSTEMS	25-28	SCREWS	
		CUTTING	
		TESTING	38
		REFERENCES	39

TECHNICAL INFORMATION, DESIGN & INSTALLATION

TECHNICAL INFORMATION

FUNCTION	
AUTHORITY	
EUROPEAN STANDARDS	
COMPOSITION	
THERMAL EXPANSION	
BIOLOGICAL AND CHEMICAL RESISTANCE	
TIMBER PRESERVATIVES	
MAINTENANCE	30

DESIGN

BUILDING REGULATIONS	
UNDERGROUND DRAINAGE	
SNOW LOADING	
RAINFALL INTENSITY	
ROOF DRAINAGE REQUIREMENTS	
GUTTER FLOW CAPACITY	
INFLUENCE OF GUTTER ANGLES	31
CALCULATION OF EFFECTIVE ROOF AREA	32

PRODUCT CATALOGUE	Page
INTRODUCTION	4
PRODUCT & COLOUR RANGE	5
RAINWATER SYSTEMS	
PROSTYLE 106mm PROFILED DOMESTIC SYSTEM	6-8
ROUNDSTYLE 112mm CLASSIC DOMESTIC SYSTEM	9-11
SQUARESTYLE 114mm MODERN DOMESTIC SYSTEM	12-14
DEEPSTYLE 115mm HIGH CAPACITY DOMESTIC SYSTEM	15-16
65mm SQUARE DOWNPIPE SYSTEM	17-18
68mm ROUND DOWNPIPE SYSTEM	19-20
HIGH CAPACITY 160mm INDUSTRIAL SYSTEM	21-22
DEEPSTYLE 170 170mm INDUSTRIAL RAINWATER SYSTEM	23-24
110mm, 160mm & 200mm INDUSTRIAL DOWNPIPE SYSTEMS	25-28

PRODUCT

BRETT MARTIN PLUMBING & DRAINAGE

Brett Martin Plumbing & Drainage are market leaders in the development of PVCu Rainwater Systems for new build and refurbishment projects for commercial, industrial, agricultural and residential applications in GB and Ireland.

GLOSS RAINWATER SYSTEMS

Brett Martin's Gloss Rainwater Systems have been designed to perform to industry standards and include features to make installation easy and straightforward.

Manufactured from high strength PVC, component parts have been designed to simply snap together for quick assembly and the systems offer excellent rigidity, particularly around fixing hole positions and retaining clips. Fixing lugs allow standard cordless power tools to be used and indicators are moulded into component parts to show correct gutter positioning, guiding the installer as to where to place gutter to allow for thermal movement. High quality integral seals also ensure a watertight joint, with twin seals incorporated into selected fittings.

The Gloss Rainwater Systems range requires little maintenance to keep the systems looking good and performing for many years.

Brett Martin's range is also compatible with a range of other manufacturer's systems and a Rainwater Compatibility Chart is available to download at www.brettmartin.com.

Brett Martin's Gloss Rainwater Systems are complemented by Brett Martin's Underground Drainage Systems, available in diameters ranging from 110mm to 400mm.

RAINWATER PRODUCT GUIDE

The Brett Martin Rainwater Product Guide illustrates all the components which make up Brett Martin Gloss Rainwater systems. Information relating to dimensions, performance, installation, design and fitting are provided. The Brett Martin Rainwater Product Guide is a comprehensive manual for architect, specifier and builder alike.

AVAILABILITY

Brett Martin's Gloss Rainwater Systems are available from builders merchants throughout GB and Ireland. There is a direct to site delivery service available for large quantities.

CONDITIONS OF SALE

Brett Martin's Gloss Rainwater Systems are sold subject to the Company's Conditions of Sale, copies of which are available on request.

Brett Martin reserves the right to change the design of any system without prior notice.

In the event of a product claim arising and where replacement product or refund is offered by Brett Martin, no other claims for costs or consequential loss will be considered.

PRODUCT & COLOUR RANGE

The Gloss Rainwater Systems range is outlined below.

The 106mm Prostyle gutter system, compatible with both 65mm square downpipe and 68mm diameter downpipe systems is available in black, anthracite grey, white, brown and arctic white. This gutter system is ideal where a more classic guttering solution is required.

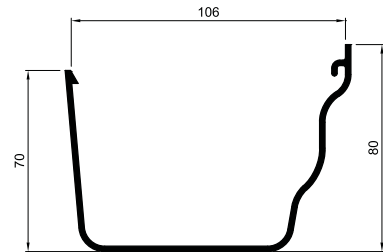

The 112mm nominal Roundstyle gutter system and 68mm diameter downpipe system, a standard in domestic rainwater systems, available in brown, white, arctic white, grey, anthracite grey and black.

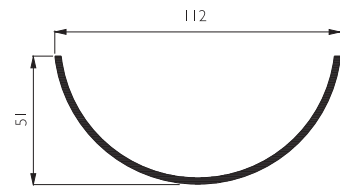

The 114mm nominal Squarestyle gutter system and 65mm square downpipe system provide a modern style for today's modern house designs, giving a greater drainage capacity than 112mm half round, available in brown, white, arctic white and black.

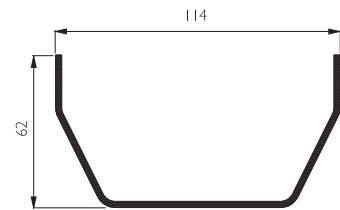

The 115mm Deepstyle gutter system, and 68mm round downpipe system is available in brown, white, arctic white, grey, anthracite grey and black. This system is extremely efficient, and can reduce the number of required downpipes in many installations, thus reducing costs dramatically.

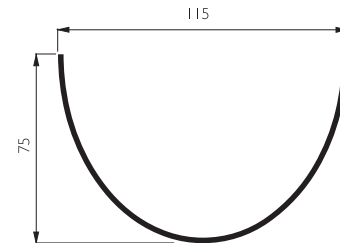

The 160mm nominal Half Round gutter system and 110mm diameter downpipe system, for use in commercial, industrial and agricultural buildings, available in grey, black and brown.

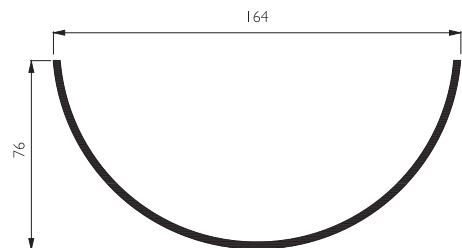

The new 170mm Deepstyle 170 gutter system and 110mm diameter downpipe, for larger industrial and commercial roofs, is available in black and grey. This maximum capacity system features innovative CLIP & SEAL technology for exceptional long-term sealing reliability.

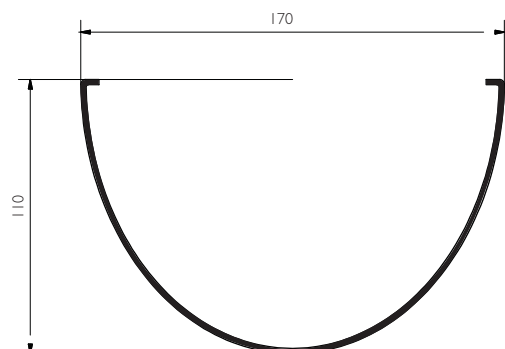

GUTTER

CODE	LENGTH	A	B	C
BR082	4m	106	70	80

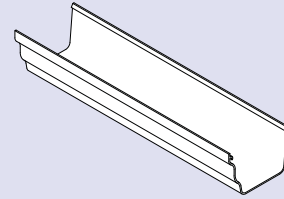
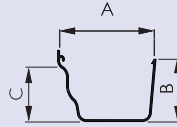

FASCIA BRACKET

CODE	A	B
BR083	127	87

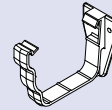
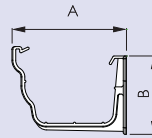

TOP HUNG FASCIA BRACKET

CODE	A	B
BR0833	119	78

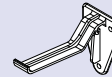
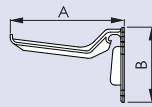

UNION BRACKET

CODE	A	B
BR084	90	129

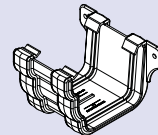
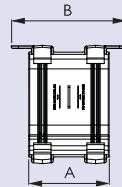

RUNNING OUTLET

CODE	A	B	C
BR085	190	92	229

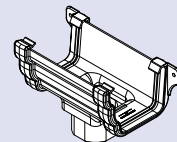
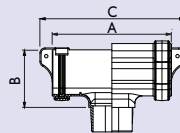

LEFT HAND STOPEND OUTLET

CODE	A	B	C
BR856L	172	92	57

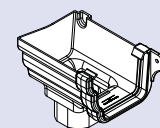
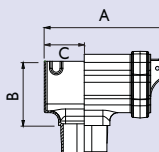

RIGHT HAND STOPEND OUTLET

CODE	A	B	C
BR856R	172	92	57

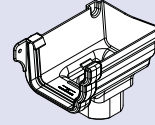
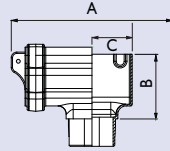

LEFT HAND EXTERNAL STOPEND

CODE	A
BR087L	37

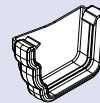
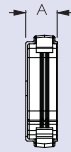

RIGHT HAND EXTERNAL STOPEND

CODE	A
BR087R	37

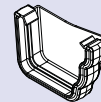
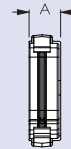

EXTERNAL GUTTER ANGLES

CODE	ANGLE	A	B
BR089E	45°	70	46
BR088E	90°	106	47
BR088/150E	150°	61	46

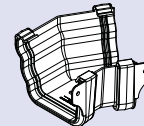
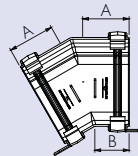

INTERNAL GUTTER ANGLES

CODE	ANGLE	A	B
BR089I	45°	70	46
BR088I	90°	106	47

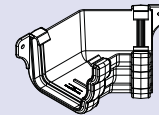
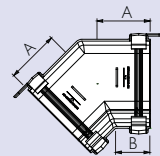

GUTTER CLIP

CODE	A
BR080	20

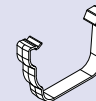
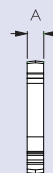

RISE AND FALL BRACKET

CODE	A	B
BRF8	275	120

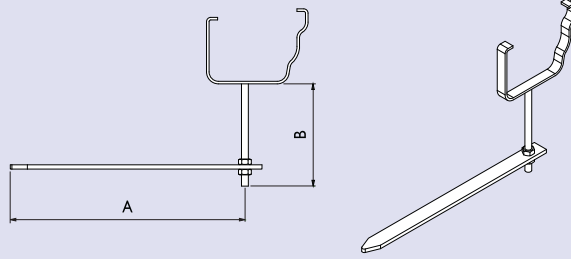

RAFTER TOP GUTTER BRACKET

CODE	A
BRT5	305

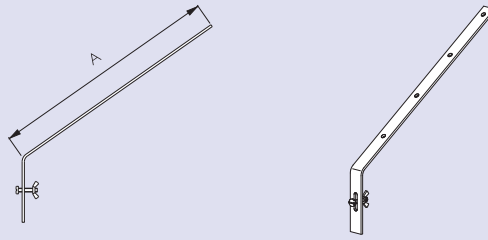

RAFTER SIDE GUTTER BRACKET

CODE	A
BRS5	293

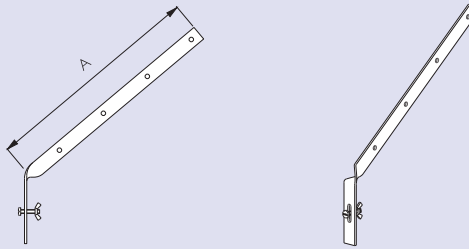

GUTTER

CODE	LENGTH	A	B
BR041	2m	112	51
BR042	4m	112	51

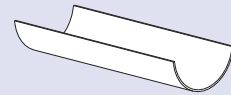
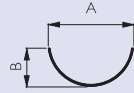

MULTI FIX FASCIA BRACKET

CODE	A	B
BR043	68	75

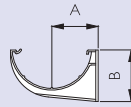

JOINT / UNION BRACKET

CODE	A	B
BR044	84	124

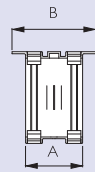

RUNNING OUTLET

CODE	A	B	C
BR045	194	91	234

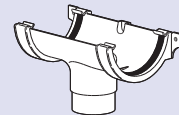
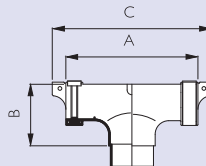

INTERNAL STOPEND

CODE	A
BR046	42



EXTERNAL STOPEND

CODE	A
BR047	40



GUTTER ANGLES

CODE	ANGLE	A	B
BR048	90°	116	48
BR048 / 120	120°	81	46
BR049	135°	72	46

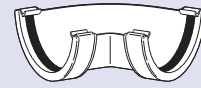
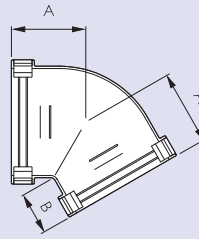

GUTTER CLIP

CODE	A
BR040	20



ROUNDSTYLE TO HALF ROUND ADAPTOR

CODE	A	B
BR491	62	73

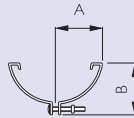

***GUTTER ADAPTOR TO OGEE**

CODE	A
BR492	Right hand 100
BR493	Left hand 100

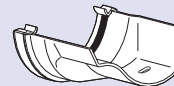
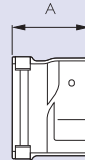

*Natural aluminium body with coloured strap

RISE AND FALL BRACKET

CODE	A	B
BRF4	280	125

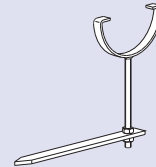
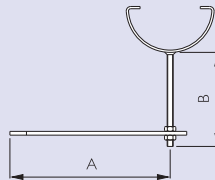

RAFTER TOP BRACKET

CODE	A
BRT5	305

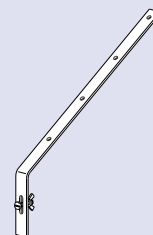
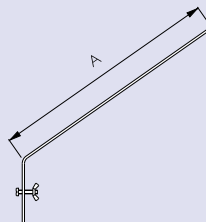

RAFTER SIDE BRACKET

CODE	A
BR55	293

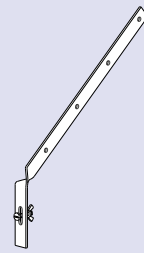
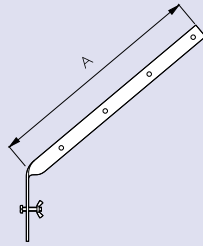

GUTTER

CODE	LENGTH	A	B
BR051	2m	114	62
BR052	4m	114	62

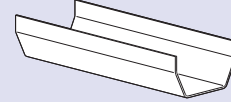
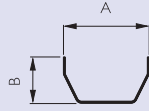

MULTI FIX FASCIA BRACKET

CODE	A	B
BR053	65	78

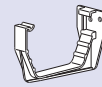
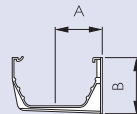

JOINT / UNION BRACKET

CODE	A	B
BR054	91	131

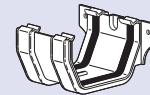
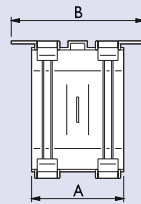

RUNNING OUTLET

CODE	A	B	C
BR055	194	98	234

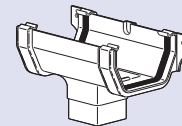
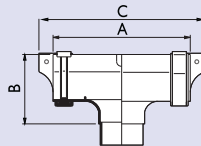

STOPEND OUTLET

CODE	A	B	C
BR0556	160	98	63

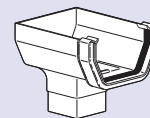
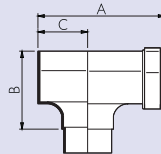

INTERNAL STOPEND

CODE	A
BR056	49

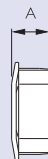

EXTERNAL STOPEND

CODE	A
BR057	50

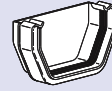
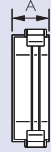

GUTTER ANGLES

CODE	ANGLE	A	B
BR058	90°	119	51
BR058 / 120	120°	90	55
BR059	135°	81	55

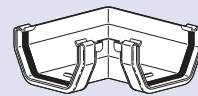
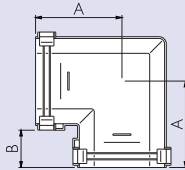

GUTTER CLIP

CODE	A
BR050	20



SQUARESTYLE TO HALF ROUND GUTTER ADAPTOR

CODE	A
BR591	94

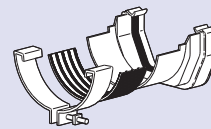
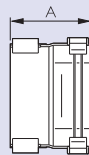

GUTTER ADAPTOR TO OGEE

CODE	A
BR592	Right hand 102
BR593	Left hand 102

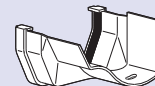
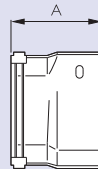

RISE AND FALL BRACKET

CODE	A	B
BRF5	270	125

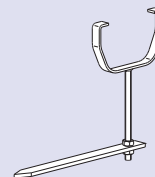
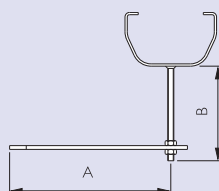

RAFTER TOP GUTTER BRACKET

CODE A
BRT5 305

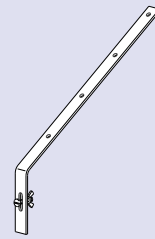
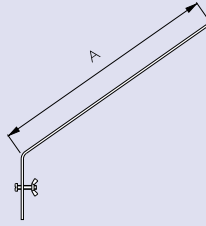

RAFTER SIDE GUTTER BRACKET

CODE A
BRS5 293

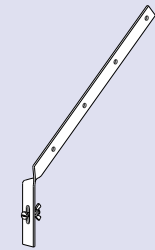
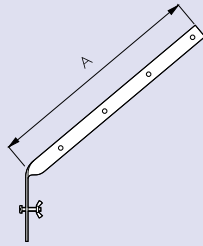

GUTTER

CODE	LENGTH	A	B
BR072	4m	115	75

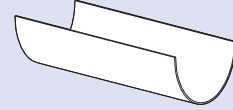
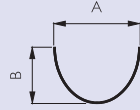

MULTI FIX FASCIA BRACKET

CODE	A	B
BR073	69	99

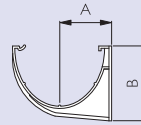

JOINT / UNION BRACKET

CODE	A	B
BR074	84	124

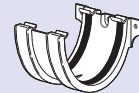
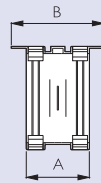

RUNNING OUTLET

CODE	A	B	C
BR075	205	116	245

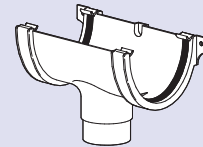
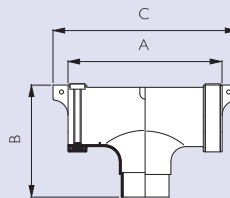

INTERNAL STOPEND

CODE	A
BR076	34

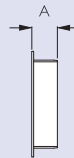

EXTERNAL STOPEND

CODE	A
BR077	40

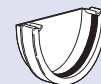
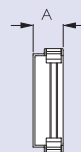

GUTTER ANGLES

CODE	ANGLE	A	B
BR078	90°	117	48
BR078 / 120	120°	87	51
BR079	135°	78	52

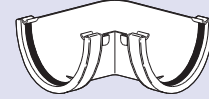
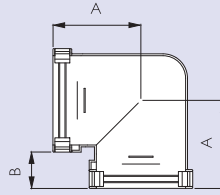

GUTTER CLIP

CODE	A
BR070	20



RISE AND FALL

CODE	A	B
BRF7	265	135

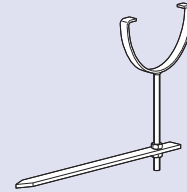
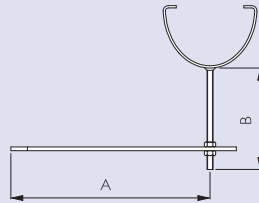

RAFTER TOP BRACKET

CODE	A
BRT5	305

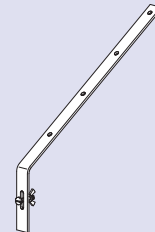
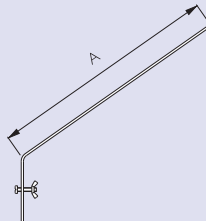

RAFTER SIDE BRACKET

CODE	A
BR55	293

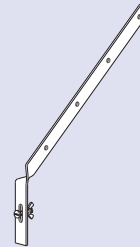
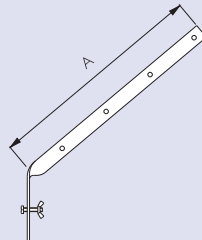

DOWNPIPE - PLAIN ENDED

CODE	LENGTH	A
BR500	2m	65
BR501	2.5m	65
BR503	4m	65
BR504	5.5m	65

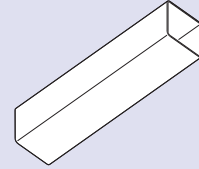

DOWNPIPE CONNECTOR

CODE	A	B
BR506	49	24



DOWNPIPE BRACKET

CODE	A	B	C
BR507	63	90	112

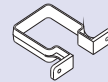
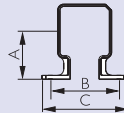

DOWNPIPE BEND - 92 1/2°

CODE	A	B	C
BR508	33	34	38

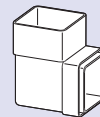
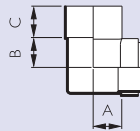

DOWNPIPE BEND TOP & BOTTOM OFFSET - 112 1/2°

CODE	A	B	C
BR509	22	41	38

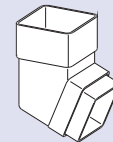
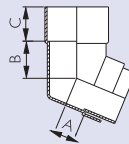

DOWNPIPE SHOE - 112 1/2°

CODE	A	B	C
BR516	50	102	38

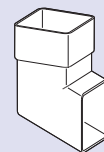
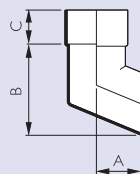

DOWNPIPE BRANCH - 112¹/₂°

CODE	A	B	C
BR518	52	91	38

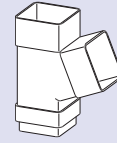
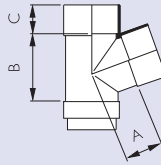

ACCESS PIPE

CODE	A	B	C
BR510	45	133	78

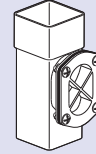
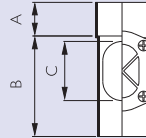

DOWNPIPE RAINWATER HEAD

CODE	A	B	OVERALL WIDTH
BR511	176	136	274

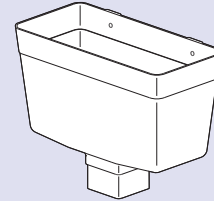
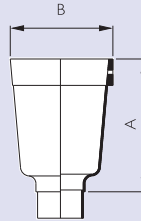

SQUARE TO ROUND ADAPTOR

CODE	A	B
BR517	46	3



UNIVERSAL ADAPTOR (SOCKET)

CODE	A	B	C
B4901	148	57	31

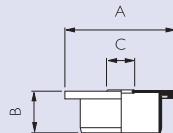

UNIVERSAL ADAPTOR (PIPE)

CODE	A	B	C
B4801	148	72	31

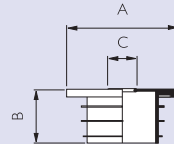

NB: Use Rainwater Adaptor BR517 to connect to Square Pipe

DRAIN CONNECTOR

CODE	A	B	C
BR520	139	55	65

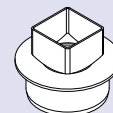
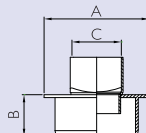

DOWNPIPE - PLAIN ENDED

CODE	LENGTH	A
BR201	2.5m	68
BR203	4m	68
BR204	5.5m	68

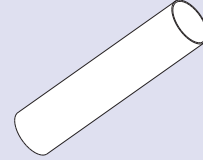

DOWNPIPE CONNECTOR

CODE	A	B
BR206	38	25



DOWNPIPE BRACKET

CODE	A	B	C
BR207	63	90	112

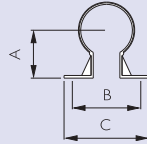

DOWNPIPE BEND TOP & BOTTOM OFFSET - 112¹/₂°

CODE	A	B	C
BR209	43	33	38

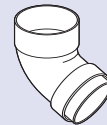
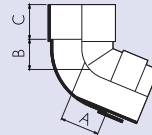

DOWNPIPE BEND - 92¹/₂°

CODE	A	B	C
BR208	39	47	37

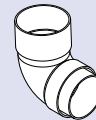
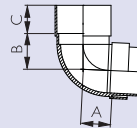

DOWNPIPE SHOE - 112¹/₂°

CODE	A	B	C
BR216	56	108	38

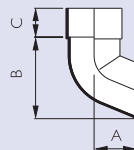

DOWNPIPE BRANCH - 112¹/₂°

CODE	A	B	C
BR218	55	91	38

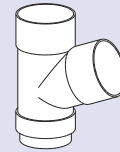
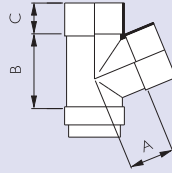

DOWNPIPE RAINWATER HEAD

CODE	A	B	OVERALL WIDTH
BR211	176	136	274

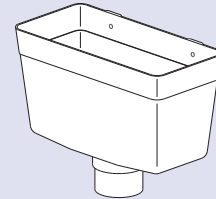
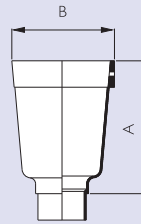

ACCESS PIPE

CODE	A	B	C
BR210	37	153	78

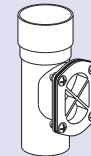
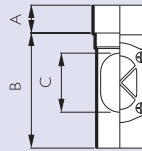

UNIVERSAL ADAPTOR (SOCKET)

CODE	A	B	C
B4901	148	57	31

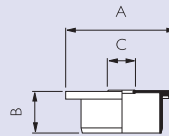

UNIVERSAL ADAPTOR (PIPE)

CODE	A	B	C
B4801	148	72	31

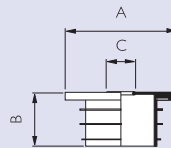

DRAIN CONNECTOR

CODE	A	B	C
BR220	139	55	68

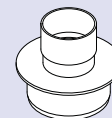
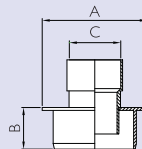

110mm TO 68mm RAINWATER ADAPTOR

CODE	A	B	C	D	E
BR223B	139	110	43	40	68

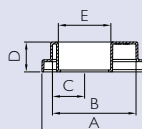

GUTTER

CODE	LENGTH	A	B
BR61	2m	164	76
BR62	4m	164	76

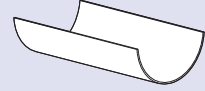
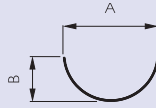

MULTI FIX FASCIA BRACKET

CODE	A	B
BR60	91	120

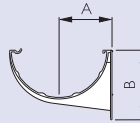

JOINT / UNION BRACKET

CODE	A
BR64	126

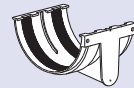
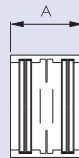

RUNNING OUTLET

CODE	A	B
BR65	244	119

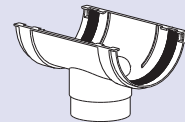
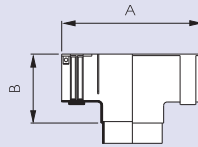

INTERNAL STOPEND

CODE	A
BR66	64

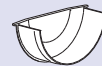

EXTERNAL STOPEND

CODE	A
BR67	53

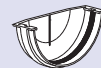

GUTTER ANGLE 90°

CODE	A	B
BR68	155	66

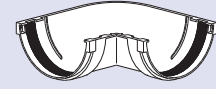
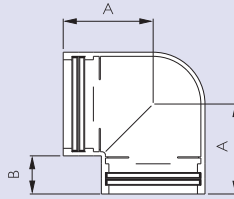

RISE AND FALL BRACKET

CODE	A	B
BRF6	265	125

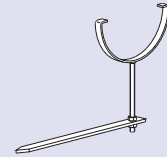
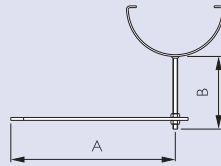

GUTTER

CODE	LENGTH	A	B
BR091	2m	170	110
BR092	4m	170	110

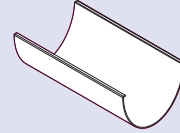
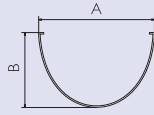

MULTI FIX FASCIA BRACKET

CODE	A	B
BR093	193	149

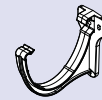
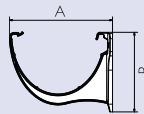

UNION BRACKET

CODE	A	B
BR094	150	200

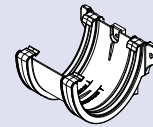
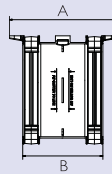

RUNNING OUTLET

CODE	A	B	C
BR095	320	160	370

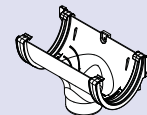
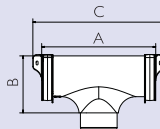

INTERNAL STOPEND

CODE	A
BR096	55



EXTERNAL STOPEND

CODE	A
BR097	57

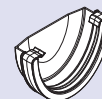

GUTTER ANGLE 90

CODE	A	B
BR098	170	80

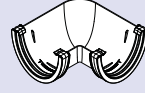
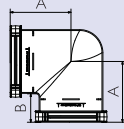

GUTTER CLIP

CODE	A	
BR090	25	



RISE AND FALL BRACKET

CODE	A	B
BRF9	330	140

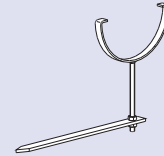
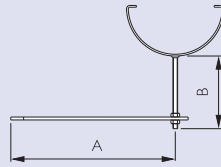

170mm TO 160mm GUTTER ADAPTOR

CODE	A	B
BR923	110	76

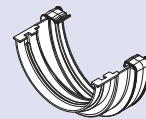
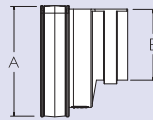

*Non-standard angles available on request.

Details of Deepstyle 170 angle and clip installation available on page 35.

DOWNPIPE - PLAIN ENDED

CODE	LENGTH	A
BS402	2.5m	110
BS403	3m	110
BS404	4m	110
BS405	6m	110
BS603	3m	160
BS604	4m	160
BS605	6m	160
B20300	3m	200
B20600	6m	200

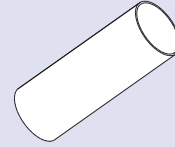

DOWNPIPE - SINGLE SOCKET

CODE	LENGTH	A
BS413	2.5m	110
BS414	3m	110
BS415	4m	110
BS430	6m	110
BS623	3m	160
BS624	4m	160
BS625	6m	160
B20003	3m	200
B20006	6m	200

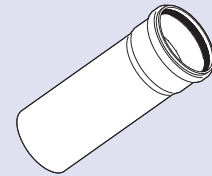
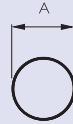

PIPE CONNECTOR - SINGLE SOCKET

CODE	SIZE	A	B
BS432	110	60	10
BR607	160	80	13

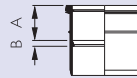

PIPE CONNECTOR - DOUBLE SOCKET

CODE	SIZE	A	B
BS406	110	51	2
BR627	160	80	4
B20021	200	94	5

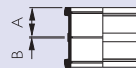

SLIP COUPLER - DOUBLE SOCKET

CODE	SIZE	A
BS478	110	104
B20022	200	193



PIPE CONNECTOR TO ASBESTOS CEMENT GUTTER OUTLET

CODE	SIZE	A	B	C (INTERNAL)
BS433	110	55	200	118
BR628	160	190	145	178

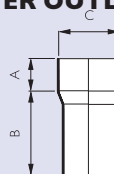

PIPE BRACKET - SINGLE FIXING

CODE	SIZE	A	B
BS438	110	90	67
BR619	160	121	88

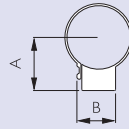

METAL PIPE BRACKET

CODE	SIZE	A	B	C
BR450	110	93	150	172
BR620	160	116	220	240

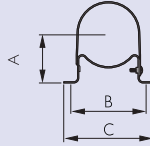

METAL PIPE BRACKET

CODE	SIZE	A	B	C
BR819	200	170	90	70

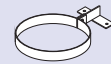
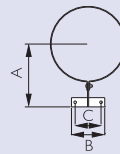

PIPE BRACKET - DOUBLE FIXING

CODE	SIZE	A	B	C
BS407	110	92	109-135	139-165

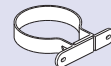
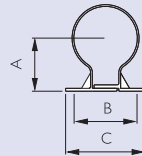

SINGLE SOCKET BEND TOP OFFSET - 112 1/2°

CODE	SIZE	A	B	C
BS408	110	64	63	63
BR630	160	99	67	79

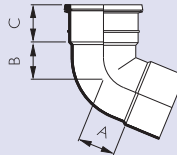

**SINGLE SOLVENT WELD SOCKET BEND
BOTTOM OFFSET - 112 1/2°**

CODE	SIZE	A	B	C
BS409	110	124	65	61
BR631	160	161	85	76

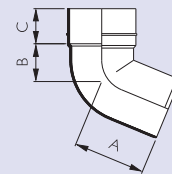

DOUBLE SOCKET BEND - 92 1/2°

CODE	SIZE	A	B	C
BS480	110	101	50	168

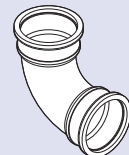
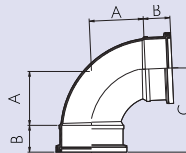

DOUBLE SOCKET BEND - 135°

CODE	SIZE	A	B
BS482	110	34	50

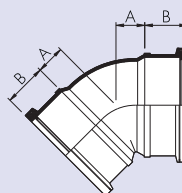

SINGLE SOCKET BENDS

CODE	SIZE	ANGLE	A	B	C
BS420	110	92½°	156	100	50
BS421	110	112½°	125	63	63
BS422	110	135°	116	50	63
BR608	160	92½°	212	141	80
BR609	160	112½°	169	83	80
BR610	160	135°	128	59	80
B20870	200	92½°	475	390	102
B20450	200	135°	210	510	102

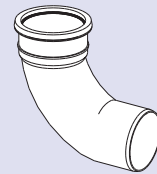
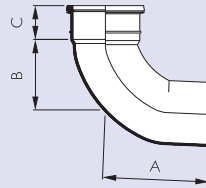

SINGLE SOCKET ACCESS BEND - 92½°

CODE	SIZE	A	B	C	D
BS436	110	142	94	53	103

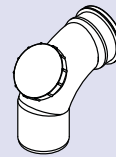
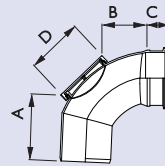

ADJUSTABLE SINGLE SOCKET BEND - 0°-30°

CODE	SIZE	A	B	C	D
BS424	110	88	51	50	140

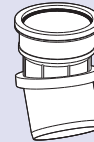
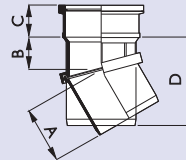

NB. Product made from polypropylene, do not solvent weld. Available in grey only.

DOWNPIPE SHOE - 112½°

CODE	SIZE	A	B	C
BS416	110	70	164	57
BR611	160	120	205	79
BR811	200	140	520	102

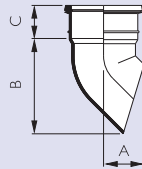

DOUBLE SOCKET ACCESS BRANCH - 92½°

CODE	SIZE	A	B	C	D	E
BS447	110	135	210	53	132	103

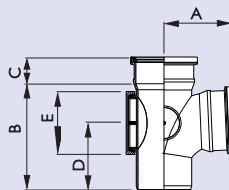

DOUBLE SOCKET BRANCH WITHOUT BOSSES

CODE	SIZE	ANGLE	A	B	C
BS417	110	92½°	156	228	67
BS448	110	104°	147	234	67
BS419	110	135°	145	253	58
BR615	160	92½°	223	312	80
BR616 (110 Branch)	160	135°	180	334	80
BR617	160	135°	205	334	80
B20110 (110 Branch)	200	135°	270	540	95
B20160 (160 Branch)	200	135°	300	540	95
B20200	200	135°	320	540	95

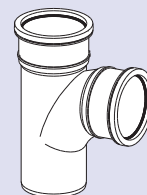
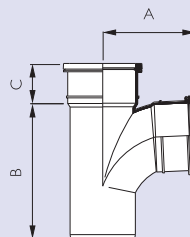

RAINWATER HEAD

CODE	SIZE	A	B	OVERALL WIDTH
BS411	110	180	200	305

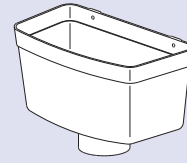
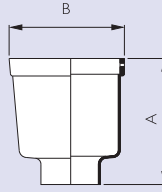

ACCESS PIPE - SINGLE SOCKET

CODE	SIZE	A	B	C	D	E
BS410	110	75	213	53	135	103

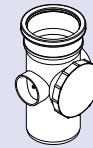
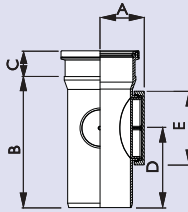

ACCESS PIPE - SINGLE SOCKET

CODE	SIZE	A	B	C	D	E
BS629	160	100	230	78	155	103

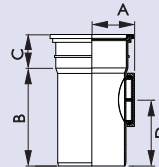

DRAIN CONNECTOR 110mm SOIL PIPE TO 160mm DRAIN

CODE	SIZE	A	B
BS423	160 X 110	57	126

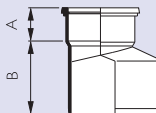

DRAIN CONNECTOR TO PVCu CAST IRON & SALT GLAZE SOCKET

CODE	SIZE	A	B
BS434	110	59	58
BR621	160	107	95

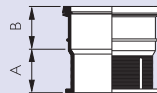

DRAIN CONNECTOR TO PVCu CAST IRON & SALT GLAZE SOCKET

CODE	SIZE	A	B
B20108	200	95	450

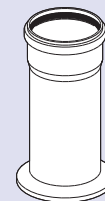
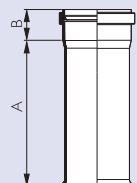

**TECHNICAL INFORMATION,
DESIGN & INSTALLATION**

TECHNICAL INFORMATION	
FUNCTION	
AUTHORITY	
EUROPEAN STANDARDS	
COMPOSITION	
THERMAL EXPANSION	
BIOLOGICAL AND CHEMICAL RESISTANCE	
TIMBER PRESERVATIVES	
MAINTENANCE	30
DESIGN	
BUILDING REGULATIONS	
UNDERGROUND DRAINAGE	
SNOW LOADING	
RAINFALL INTENSITY	
ROOF DRAINAGE REQUIREMENTS	
GUTTER FLOW CAPACITY	
INFLUENCE OF GUTTER ANGLES	31
CALCULATION OF EFFECTIVE ROOF AREA	32
INSTALLATION	
HANDLING	
STORAGE	
A TYPICAL RAINWATER SYSTEM	33
GUTTER INSTALLATION	34
GUTTER SUPPORT SPACING	
FITTING GUTTER	35
DEEPSTYLE 170 ANGLE AND CLIP INSTALLATION	35
DOWNPIPE INSTALLATION	36
CONNECTION TO UNDERGROUND DRAINAGE	
SCREWS	
CUTTING	
TESTING	38
REFERENCES	39

TECHNICAL

FUNCTION

Brett Martin PVC Rainwater systems comprise gutter sections and fittings, with accompanying downpipe sections and fittings to efficiently convey rainwater from the roofs of domestic, commercial and industrial buildings.

Brett Martin Rainwater systems are complemented by the Brett Martin Drain, Sewer, Surface Water, Soil and Waste systems, providing a complete solution for all drainage requirements.

AUTHORITY

Brett Martin Rainwater systems satisfy the requirements of the following:

- The Building Regulations 2010, as amended
- Building (Scotland) Regulations 2004, as amended
- Building Regulations (Northern Ireland) 2012, as amended.
- The Building Regulations 2010 (ROI), as amended

EUROPEAN STANDARDS

BS EN ISO 9001:2008

EN 12200-1:2000 Plastics rainwater piping systems for above ground external use - Unplasticized poly (vinyl chloride) (PVC-U)

EN 607:2004 Eaves, gutters and fittings made of PVC-U

EN 1462:2004 Brackets for eaves gutters - requirements and testing

EN 1329:2014 Plastics piping systems for soil and waste discharge (low and high temperature) within the building structure - Unplasticized poly (vinyl chloride) (PVC-U)

COMPOSITION

Extruded gutter and downpipe sections and injection moulded fittings are made from PVC compounds complying with the material requirements of EN 12200-1:2000 and EN 607:2004, containing the necessary processing additives, stabilisers and pigments to give products excellent appearance, durability, and performance. Seals in the gutter and downpipe fittings are manufactured from materials complying with EN 681:1996.

THERMAL EXPANSION

PVC has a coefficient of linear expansion of 6×10^{-5} . Consequently a 2m length of gutter or downpipe will expand by 2.4mm for a 20°C temperature rise. This expansion is taken into consideration in the design of Brett Martin Rainwater fittings and must be accommodated when installing.

BIOLOGICAL AND CHEMICAL RESISTANCE

Polluted industrial atmospheres will not effect Brett Martin rainwater systems. PVC is vermin and rot proof and resistant to most commonly occurring chemicals: notable exceptions however are solvents, including those incorporated in most timber preservatives.

TIMBER PRESERVATIVES

Wood preservative, which has been applied to a timber surface, must be allowed to dry thoroughly before any Rainwater fitting is fixed to that surface.

MAINTENANCE

The security of gutter and downpipe brackets should be checked regularly as part of the overall building maintenance programme: check also that no components have become dislodged or loose and that the gutter extrusions have not moved beyond any of the thermal expansion allowance marks in the fittings.

Rainwater gutter systems should be cleaned out on a regular basis, at least annually, more frequently in locations where there are large amounts of wind borne debris, eg. in sandy areas or in close proximity to deciduous trees. The high gloss surface finish retains little dirt. A mild detergent solution is ideal when cleaning dirt from the external surface is necessary.

Brett Martin Rainwater systems are self coloured, painting is not normally required for several years after installation. When painting is carried out, the surfaces of all components should be lightly roughened with sandpaper and cleaned. An oil based gloss paint is the most suitable. Do not use an undercoat.

BUILDING REGULATIONS

Brett Martin Rainwater installations should be designed to comply with the following:

- The Building Regulations 2010, Approved Document H, Section H3.
- Building (Scotland) Regulations 2004, Technical Handbook (Domestic & Non-Domestic) Section 3: Environment
- The Building Regulations (Northern Ireland) 2012, Technical Booklet N: Section 4
- Building Regulations 2010 (ROI), Part H, Section 1.5

Comprehensive guidance on the design and installation of rainwater systems is given in BS EN 12056-3: 2000 Roof Drainage Layout and Calculation.

UNDERGROUND DRAINAGE

It is necessary to dispose of the runoff collected by Brett Martin Rainwater systems in an efficiently designed underground drainage system. A Local Authority may permit the runoff to be conveyed in a combined sewer and rainwater system, or in a separate rainwater only system. Complete Brett Martin Drain and Surface Water systems are available for these applications - see Brett Martin Underground Product Guide.

SNOW LOADING

Heavy snow falls can create hazards on steep roof pitches and/or on smooth roof surface finishes when the accumulated snow slips down and off the roof. Additional support brackets (maximum 600mm centres) can cope with some extra snow load. However, the chances of a combination of snow loading on steep and/or smooth roof surfaces, coupled with improved roofspace insulation, necessitate the recommendation for the fitting of snow boards close to eaves to prevent damage to the installation and/or other property or person(s) below. (See Page 33). Also, in some Northern areas of the UK, where heavier snow can be anticipated, snow boards should be considered on less steep roofs. Wherever fixing points are provided in any gutter fittings, these must be utilised during installation.

RAINFALL INTENSITY

Rainfall intensity in the UK varies with location and surrounding topography: a rainfall intensity of

75mm / hour is usually taken as the UK maximum when calculating the discharge requirements for gutter, downpipe and underground drainage systems.

ROOF DRAINAGE REQUIREMENTS

The amount of rainwater collected by a given roof area largely determines the choice of gutter system to be used and the number and positioning of the outlets. It is necessary to calculate the effective area of a roof and to relate this to the draining capabilities of the Brett Martin Rainwater systems.

GUTTER FLOW CAPACITY

The draining capacity of a gutter system is determined by the gutter gradient and the size and positioning of the outlets.

PROSTYLE 106mm PROFILED DOMESTIC SYSTEM

1:600 FALL	OUTLET AT CENTRE	OUTLET AT END
FLOW CAPACITY	5.1 l/sec	2.55 l/sec
MAX ROOF AREA	242m ²	121m ²

ROUNDSTYLE 112mm CLASSIC DOMESTIC SYSTEM

1:600 FALL	OUTLET AT CENTRE	OUTLET AT END
FLOW CAPACITY	2.43 l/sec	1.3 l/sec
MAX ROOF AREA	116m ²	62m ²

SQUARESTYLE 114mm MODERN DOMESTIC SYSTEM

1:600 FALL	OUTLET AT CENTRE	OUTLET AT END
FLOW CAPACITY	3.03 l/sec	1.52 l/sec
MAX ROOF AREA	144m ²	72m ²

DEEPSTYLE 115mm HIGH CAPACITY DOMESTIC SYSTEM

1:600 FALL	OUTLET AT CENTRE	OUTLET AT END
FLOW CAPACITY	4.58 l/sec	2.3 l/sec
MAX ROOF AREA	220m ²	110m ²

HIGH CAPACITY 160mm INDUSTRIAL SYSTEM

1:600 FALL	OUTLET AT CENTRE	OUTLET AT END
FLOW CAPACITY	6.47 l/sec	3.23 l/sec
MAX ROOF AREA	310m ²	155m ²

INFLUENCE OF GUTTER ANGLES

When there is a gutter angle closer than 2m to the outlet, reduce the effective roof area that can be drained by 10%. When there is a gutter angle more than 2m from the outlet, reduce the area that can be drained by 5%.

**CALCULATION OF EFFECTIVE
ROOF AREA**

FLAT ROOF

For a flat roof the effective roof area is simply the plan area of the roof.

SLOPING ROOF

For complex roof structures involving several or unequal slopes, a method of calculation is given in BS EN 12056-3: 2000. In the case of simple roof slopes, as illustrated below, the effective roof area is derived from the formula $E = (B + C/2) \times L$ where
 B = half roof span (m)
 C = ridge to eaves height (m)
 L = slope length (m)
 E = effective roof area (sq. m)

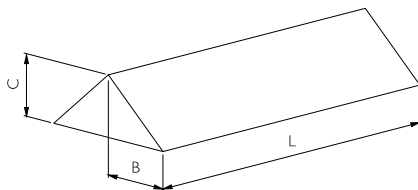

RAINWATER RUNOFF

The amount of rainwater runoff R from a calculated effective roof area E is given by the formula:

$$R = 0.021 \times E \text{ litres / sec}$$

EFFECTIVE AREA OF WALLS

Walls above abutting roofs drain on to the roofs below, adding to the amount of water which the rainwater system fitted to the roof has to convey.

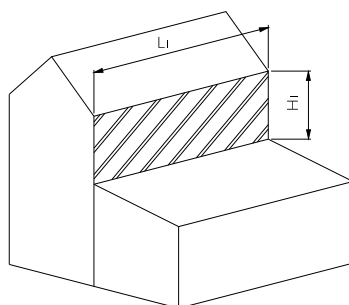

For a single wall the effective catchment area is taken to be half the area of the elevation.

$$E = 1/2 (L_1 \times H_1) \text{ m}^2$$

AN EXPLODED VIEW OF A TYPICAL BRETT MARTIN RAINWATER INSTALLATION

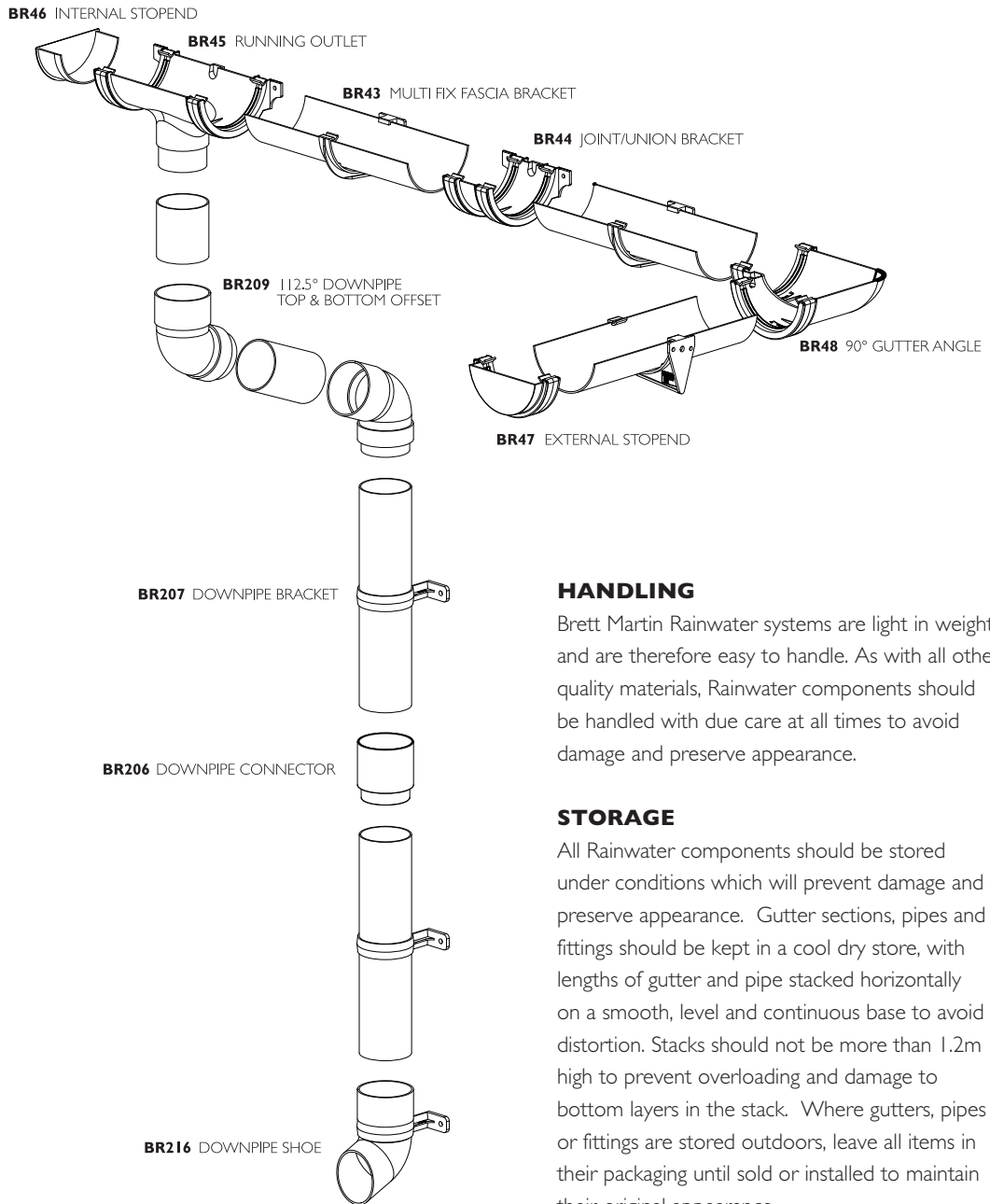

HANDLING

Brett Martin Rainwater systems are light in weight and are therefore easy to handle. As with all other quality materials, Rainwater components should be handled with due care at all times to avoid damage and preserve appearance.

STORAGE

All Rainwater components should be stored under conditions which will prevent damage and preserve appearance. Gutter sections, pipes and fittings should be kept in a cool dry store, with lengths of gutter and pipe stacked horizontally on a smooth, level and continuous base to avoid distortion. Stacks should not be more than 1.2m high to prevent overloading and damage to bottom layers in the stack. Where gutters, pipes or fittings are stored outdoors, leave all items in their packaging until sold or installed to maintain their original appearance.

GUTTER INSTALLATION

Brett Martin Rainwater gutters, in all five sizes, can be efficiently installed if the following procedures are followed.

Rainwater systems are supported by the outlet joint/union bracket and external angles as well as the gutter support brackets, all of which must be fixed, wherever possible to the fascia or support bracket, or the system securely held by rise and fall brackets, to ensure trouble-free lifetime service.

INSTALLATION SEQUENCE

- Position the gutter outlet vertically above the drain inlet or gully from which the rainwater will be conveyed to the underground drainage system.
- Fix the outlet in position on the fascia allowing for whatever fall, if any, is required.
- Fix the gutter support bracket furthest from the outlet at a position on the fascia which will produce a run of gutter either horizontal or to the desired fall.
- Stretch a line taut between the fixed outlet and support bracket, establishing a straight gutter line.
- Fix the remainder of the fittings to the fascia following this line, a joint bracket being positioned at each junction of two gutter sections.
- Where, due to the absence of a fascia or the design of the building support fittings cannot be fixed, the rafter top bracket and side bracket provide alternatives.
- Rise and fall brackets driven into the wall will support the gutter system where there is no fascia and rafter brackets are impractical. Position these against alternate sides of joint brackets, running outlets or angles along the installation to prevent excessive thermal movement in any one direction.

RAFTER TOP BRACKET

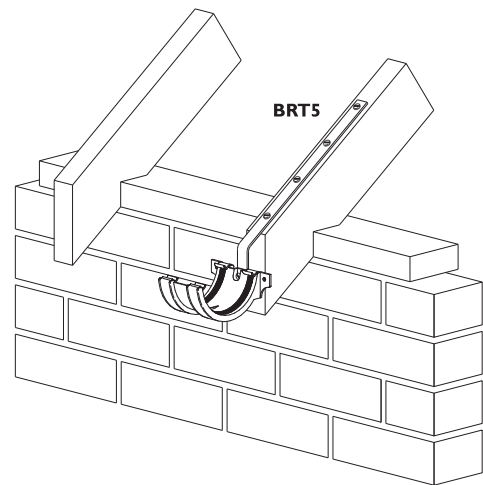

RAFTER SIDE BRACKET

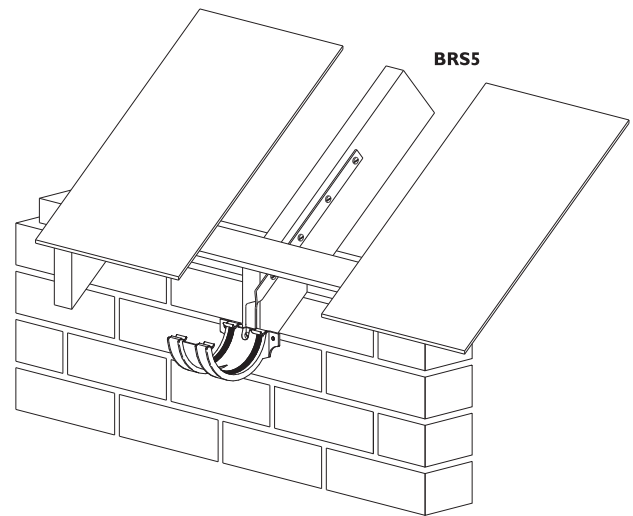

RISE & FALL BRACKET

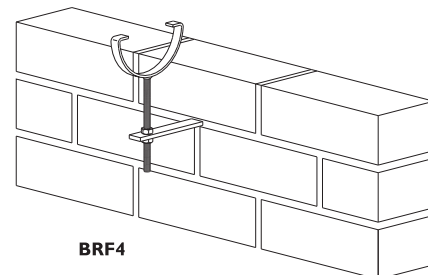

GUTTER SUPPORT SPACING

Gutter support spacing should normally NOT EXCEED 900mm. Roofs with a pitch of, or exceeding, 35° and/or with SMOOTH SURFACES should prompt consideration of the effects of HEAVY SNOW LOADING. Improved roofspace insulation now prevents snow from melting on impact and is more likely to accumulate to a critical amount.

In such instances, support spacing centres should NOT EXCEED 600mm and snow boards should be fitted. All gutter fittings incorporate fixing positions, which must be used during installation.

Where gutter angles are required, relevant holes should be drilled to enable fixing to the fascia board and adjacent support brackets should be no more than 900mm away. If the angle is unable to be fixed, the adjacent brackets should be no more than 150mm away.

FITTING GUTTER

To snap the gutter section into the support fittings, first push the rear edge of the gutter up hard under the rear retaining clip of the fitting. Then pull the front edge of the gutter out and down with one hand, and the front edge of the support fitting out and down with the other hand, while pushing the front retaining clip over the front edge of the gutter with the thumbs, until the gutter snaps into place.

THERMAL MOVEMENT ALLOWANCE

When each length of gutter has been snapped into position check that each end is not inserted into the fitting beyond the 'EXPANSION ALLOWANCE' line. This allows the gutter to move with changes in temperature without distortion.

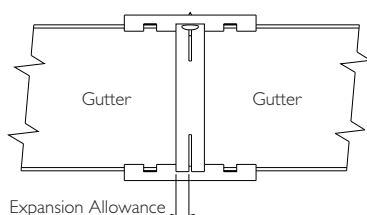

To ensure the joint remains intact, each gutter fitting should be fixed to the fascia board or rafter bracket wherever possible.

DEEPSTYLE 170 ANGLE & CLIP INSTALLATION

170mm Gutter Clips are asymmetrical to give the clips a better hold on the gutter.

It is recommended that the overhanging side of the clip is kept closest to the wall.

Fittings come preassembled however as only one 90 degree angle is provided it is preassembled for a wall on the inside of the corner. When the wall lies on the outside of the corner it is then advised that the clips are swapped around.

SWAPPING CLIPS

- Remove the seal from the seal recess.
- Take off the clip by removing the horizontal side first.
- Put the clip back on in the opposite orientation.
 - Place the overhanging side on first.
 - Then slide the other end of the clip along the outside of the seal recess until it snaps over the top of the fitting.
 - Ensure both sides of the clip are fully engaged with the fitting - you should hear a click.
- Reinsert the seal
 - The seal has a central hole into which the clip is designed to engage- this will ensure that the seal cannot rock out of place when in use.
 - Feed one end of the seal into the seal recess allowing the clips protrusion to engage with the seal. (You should feed the seal into the overhanging side of the clip first).
 - You should then feed the other end of the seal so that the opposite side of the clip is also engaged.
 - Flatten out the rest of the seal into its recess.
 - As you apply some pressure to the seal you should feel its feet engaging with the recess correctly.
 - Ensure that both sides of the seal are engaged with the clip to a similar extent.

DOWNPIPE INSTALLATION

Downpipe installations must accommodate thermal movement. This accommodation of approximately 10mm is made at the top of each 65mm and 68mm pipe section, but at the bottom of each 110mm and 160mm pipe section.

Spigot to socket joints in the 65mm and 68mm systems require the insertion of a piece of pipe of length equal to socket depth to produce a secure fit.

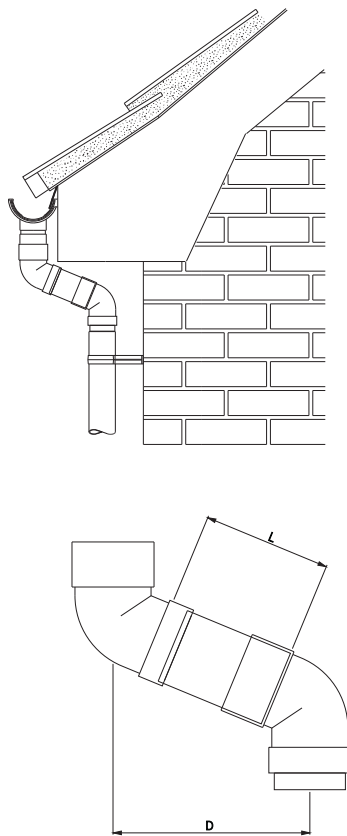

TABLE 1

MINIMUM SOFFIT DEPTHS & OFFSET PIPE LENGTHS

DOWNPIPE	MIN. SOFFIT DEPTH "D" (mm)	OFFSET PIPE LENGTH "L" (mm)
65mm	120	38
68mm	115	38
110mm	235	122
160mm	300	155

INSTALLATION SEQUENCE

- Commence assembly of the downpipe by fabricating an offset from the gutter outlet to the wall using a top and bottom offset bend connected by a length of pipe cut to suit the soffit depth of the building - Table 2. The 110mm and 160mm offset bend sockets must be solvent welded to the pipe.

TABLE 2

SOFFIT DEPTHS / OFFSET PIPE LENGTHS

SOFFIT DEPTH "D"	OFFSET PIPE LENGTH "L"			
	65mm SQUARE	68mm ROUND	110mm ROUND	160mm ROUND
150	80	85		
175	107	113		
200	137	140		
225	161	167		
250	188	194	148	
275	215	221	175	
300	242	248	202	155
325	269	275	229	182
350	296	302	256	209
375	324	329	283	236
400	351	356	310	263
425	378	383	337	290
450	405	410	364	317
475	432	437	391	344
500	459	464	418	371

- Insert a piece of pipe, length at least equal to socket depth, or otherwise to suit fascia depth, into the top offset bend socket, and fit tightly underneath the running outlet. Secure the bottom offset bend to the wall with a bracket so that the entire assembly is a solid fit under the outlet.

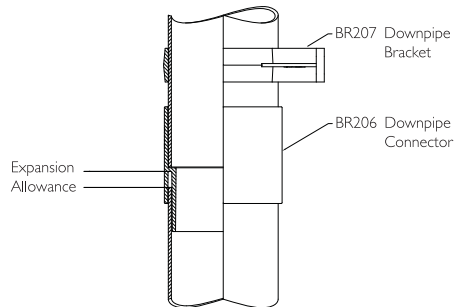

- Fit the downpipe working from the top. When the pipe is 65mm or 68mm place the bottom end into a downpipe connector, and secure the connector to the wall using a pipe and fitting bracket, leaving a 10mm thermal movement allowance at the top. Secure 110mm and 160mm pipe at the top using a pipe and fitting bracket under the socket shoulder. The lower end of this pipe must be inserted 10mm less than the full socket depth when connecting the next pipe or fitting.
- Fit additional lengths of pipe or fittings using the same principles to achieve thermal movement allowance at the top or bottom depending on downpipe size. Secure with a bracket at each fitting or socket, and on the pipe as necessary to ensure support at centres no greater than 2m.

DOWNPIPE INSTALLATION EXCEEDING 10m IN HEIGHT

- Galvanised metal brackets **MUST** be used to support the installed weight of 110mm and 160mm systems of height greater than 10m.

CONNECTION TO UNDERGROUND DRAINAGE

Downpipe may be connected to the underground drainage system in a number of ways.

In domestic applications where the 68mm round and 65mm square downpipes are used, they commonly discharge through a shoe into the hopper of a gully.

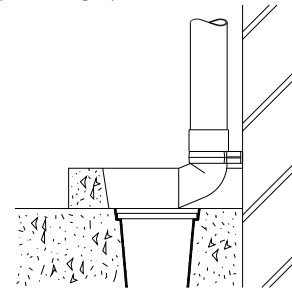

Alternatively the rainwater can discharge into a back inlet gully through an adaptor and bend.

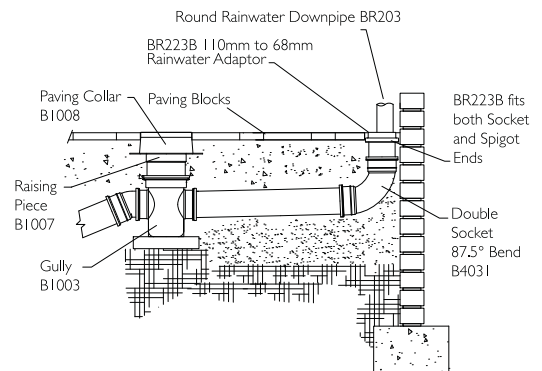

It is possible to connect the 110mm downpipe directly to a PVC underground drainage system: where this is of greater diameter an adaptor can be used.

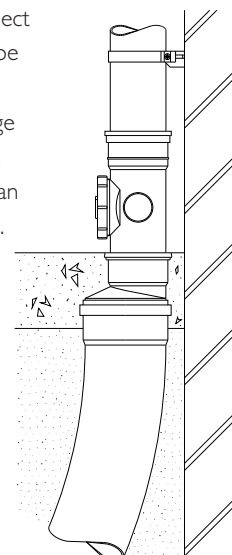

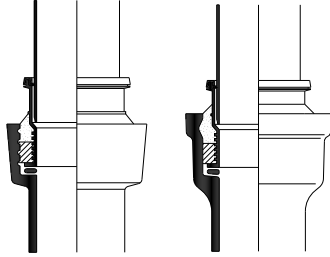

Adaptors are also available to connect Rainwater downpipes to underground drainage systems of other materials.

SCREWS

All fittings should be fixed with 25 × 5mm round head screws. These should be sherardised or otherwise protected against corrosion. **Do not use nails in any circumstances.**

CUTTING

Gutter and downpipe sections can be cut with a hand saw having 6-8 teeth per cm, held at a shallow angle, and sawing with slow steady strokes. A file should be used to remove any swarf or burrs. Clean all cuttings and swarf from the gutter and downpipe ends to avoid damaged or ineffective seals. Lubricate all seals in gutter and downpipe fittings for ease of installation.

TESTING

When rainwater installations are complete, gutters should be tested for watertightness under working conditions and internal downpipes should also be tested as prescribed in the relevant Building Regulations. Attention should be paid to the requirements of local authorities. Guidance is also given in BS EN 12056-3:2000.

REFERENCES

BS EN ISO 9001:2008: Quality Management Systems Requirements

BS EN 12200-1:2000: Plastics rainwater piping systems for above ground external use. Unplasticized poly (vinyl chloride) (PVC-U). Specifications for pipes, fittings and the system

BS EN 607:2004: Eaves gutters and fittings made of PVC-U. Definitions, requirements and testing

BS EN 1462:2004 Brackets for eaves gutters – Requirements and testing

BS EN 1329-1:2014: Plastics piping systems for soil and waste discharge (low and high temperature) within the building structure. Unplasticized poly(vinyl chloride) (PVC-U). Specifications for pipes, fittings and the system

BS EN 681-1:1996: Elastomeric seals. Material requirements for pipe joint seals used in water and drainage applications. Vulcanized rubber

The Building Regulations 2010

Building (Scotland) Regulations 2004

Building Regulations (Northern Ireland) 2012

The Building Regulations 2010 (ROI)

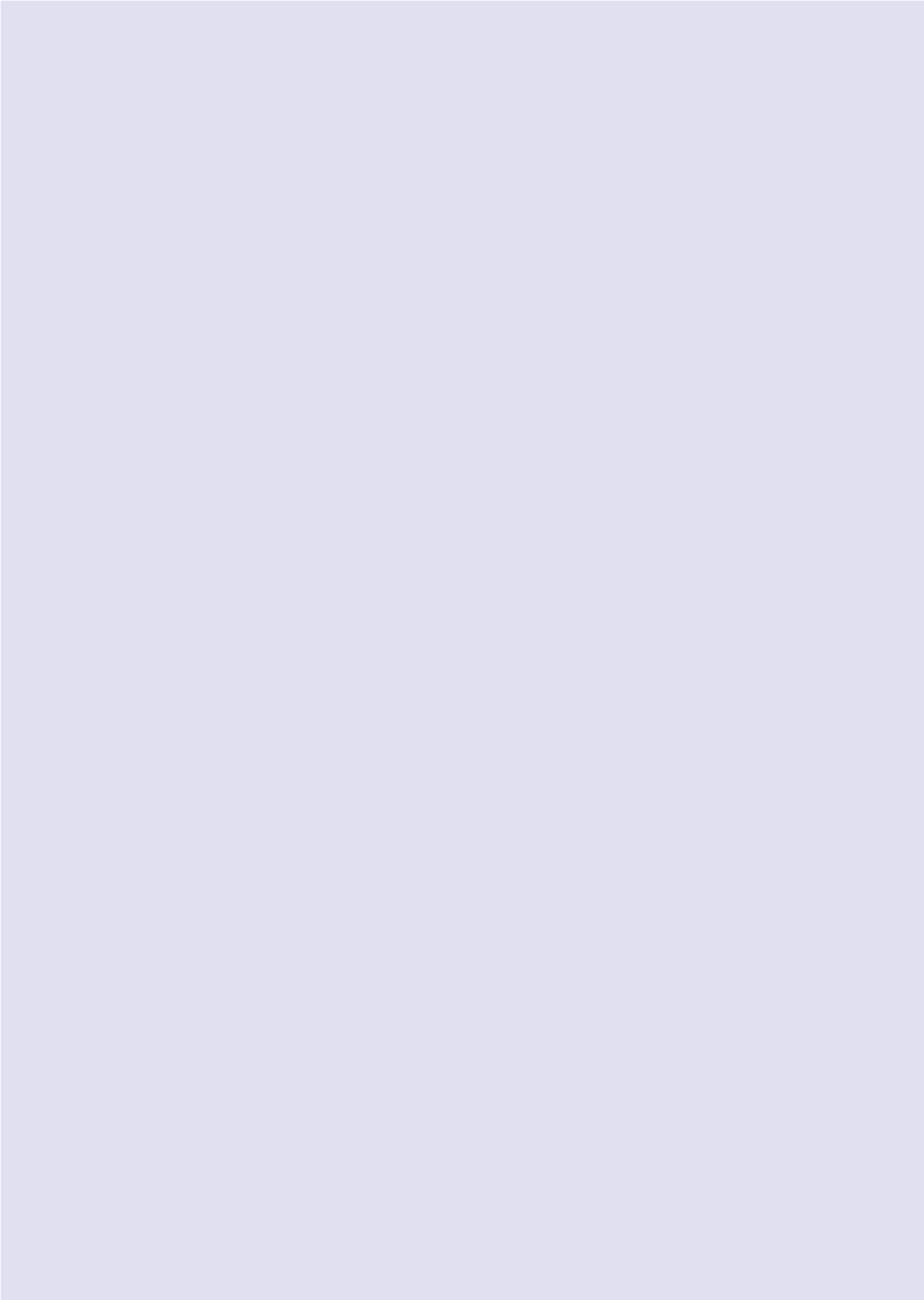



All reasonable care has been taken in the compilation of the information contained within this literature. All recommendations on the use of our products are made without guarantee as conditions of use are beyond the control of Brett Martin. It is the customer's responsibility to ensure that each product is fit for its intended purpose and that the actual conditions of use are suitable.

Brett Martin pursues a policy of continuous product development and reserves the right to amend specifications without prior notice.

Copyright Brett Martin Ltd

