



Lindab Rainline™

Lindab Roof Drainage System Technical Information

Dimensioning

Roof drainage

Dimensioning can be done according to Swedish Standard SS or the Advice and instructions for the code of practice, "Hus AMA, RA 08 Hus".

Dimensioning to SS gives smaller dimensions than if RA 08 Hus is used. This

is because RA 08 Hus has given some consideration to the tendency of gutters to fill up with sludge from leaves and loose material on roof cladding etc. SS compensates this by specifying a smallest fall for self-clearance of 5-7 mm/m,

depending on dimensions. Diagrams and tables based on the dimensioning instructions in SS and Hus AMA are included below.

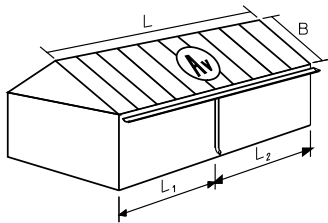

A_v = True roof area
 L_1 and L_2 = Distance from building corner

Example

Roof area $L = 20$ m, $B = 9$ m $\rightarrow A_v = 180$ m²
 A down pipe located 11.6 m from one end

$$\rightarrow \frac{L_1}{L_1 + L_2} = \frac{11.6}{20} = 0.58$$

Result

You can choose a half round gutter of R125 or larger.
 The down pipe from the second diagram should then be SRÖR75.

Dimensioning to SS

SS diagrams contain curves for various rain intensities. It approves the assumption that the probable rain intensity can be specified as 0.013 l / (sm²) on areas less than 10,000 m² for the whole country, which is what our diagram is based on. SS assumes that the gutter is laid with a smallest fall of 2.5 mm/m. Since SS does not cover our entire product range, the curves in SS have been extrapolated. It should be noted that the dimensioning instructions in SS can give a relationship between gutters and down pipes which does not correspond with the product standard for nozzles. This is because of traditional and appearance demands for size matching between gutters and down pipes.

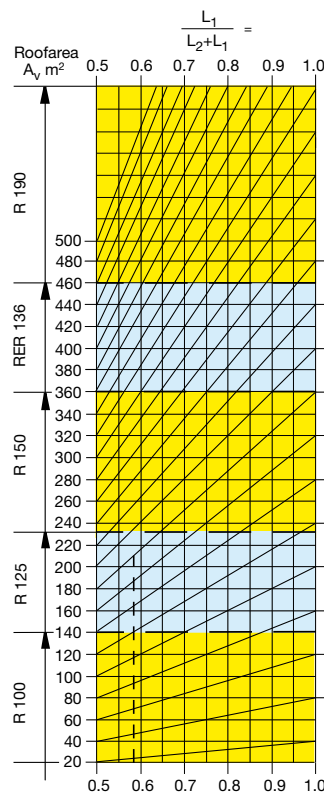
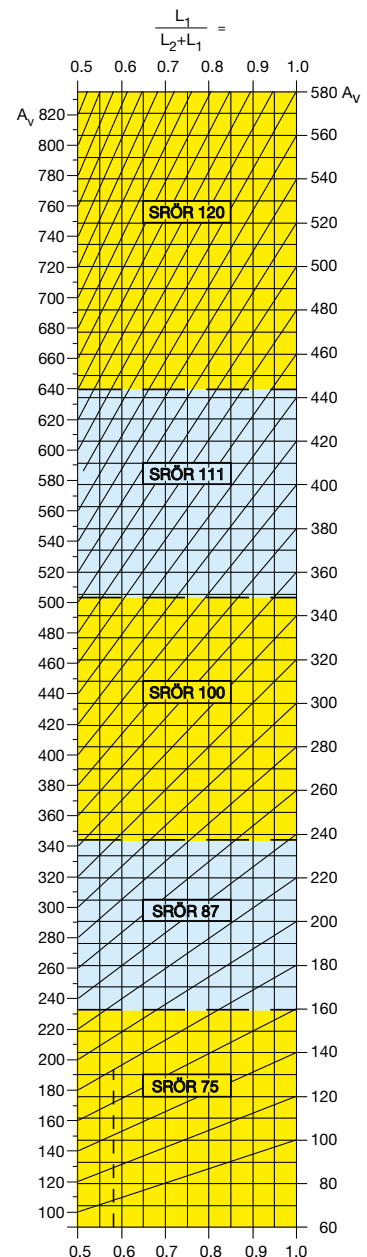

Technical Facts

Rainline

Colour chart

Number	Name	Nearest NCS	Nearest RAL
001	Antique white	S 1002-G50Y	9002
015	Black	S 9000-N	9005
044	Antracite metallic	S 6000-N	9007
045	Silver metallic	-	9006
087	Dark grey	S 7005-B20G	7011
434	Brown	S 8005-Y80R	8017
742	Tile red	S 4040-Y80R	8004
758	Dark red	S 5040-Y80R	3009
778	Copper metallic	S 4030-Y60R	8003
830	Pine green	S 7010-G30Y	6020

Other material

-	Aluminium-zinc	-	-
---	----------------	---	---

Technical Facts

Gutter with accessories

R Gutter

Dim	D mm	d mm	Area* mm ²	Area** mm ²
100	107	17	4500	4100
125	123	17	5900	5500
150	155	17	9400	8900
190	192	22	17300	16200

*Sectional area **Water carrying area (6 mm lower front edge, 190 gutter 11mm)

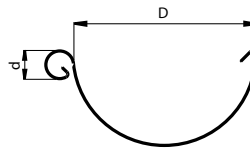

RSK Gutter joint

Dim
100
125
150

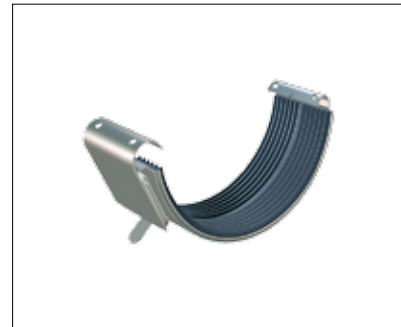

SSK Adjustable snap bracket

Dim
100
125
150

To SS-EN 1462 Class A-H

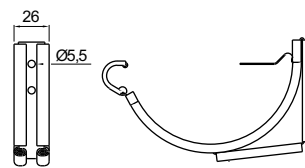

STAG Stay strap

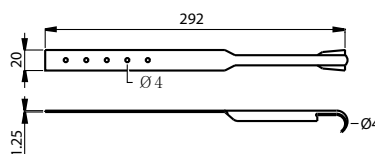

Technical Facts

Gutter with accessories

K33/K24/K21/K16/K07 Bracket

Dim	L mm				
	K33	K24	K21	K16	K07
100				160	70
125			210	160	70
150			210	160	70
190	334	244			

To SS-EN 1462 Class A-H

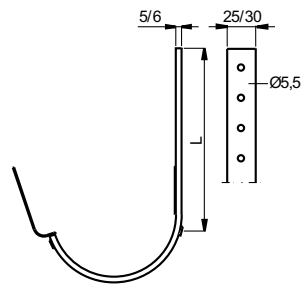

K11 Bracket for 27° roof pitch

Dim
100
125
150

To SS-EN 1462 Class A-H

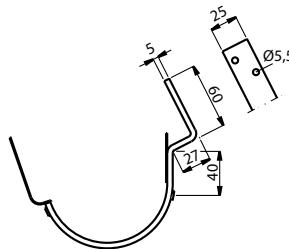

KFL35/KFL/KFM Bracket

Dim	L mm		
	KFL35	KFL	KFM
100		196	
125	336	196	146
150	336	196	146

To SS-EN 1462 Class A-H

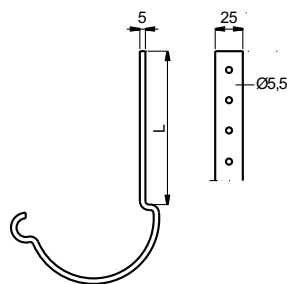

KFK Fascia Bracket

Dim
100
125
150

To SS-EN 1462 Class A-H

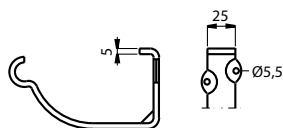

Technical Facts

Gutter with accessories

KBO Bracket bender



TB Cover brace

Dim
100
125
150

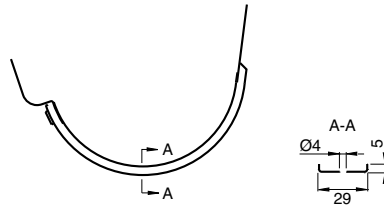

OMV Gutter outlet

Dim D/d	A mm	H mm
100/75	156	56
100/87	156	48
125/75	174	67
125/87	174	59
125/100	174	50
150/87	212	82
150/100	212	73
150/111	212	66
150/120	212	60
190/100	180	62
190/120	206	62

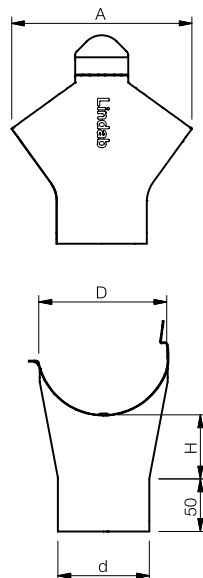

Technical Facts

Gutter with accessories

RG Stop end

Dim
125
150

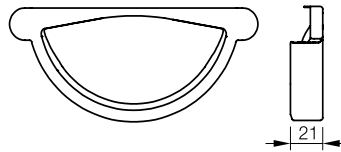

RGV/RGH Stop end

Dim
100
125
150
190

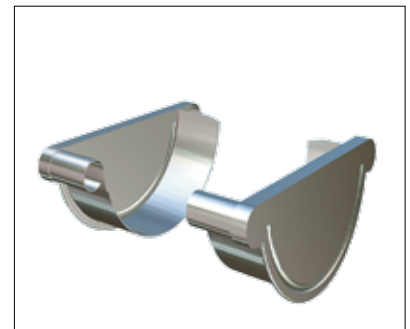
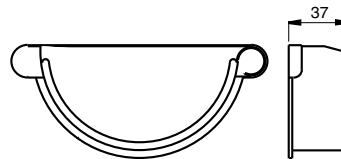

RVI Gutter angle, inner

Dim	L mm
100	400
125	300
150	300
190	500

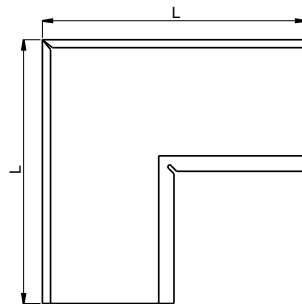

RVY Gutter angle, outer

Dim	L mm
100	295
125	175
150	245
190	285

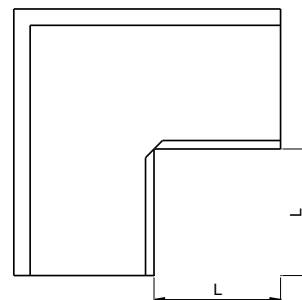

Technical Facts

Gutter with accessories

RVI135 Gutter angle 135°, inner

Dim	L mm
100	300
125	300
150	300

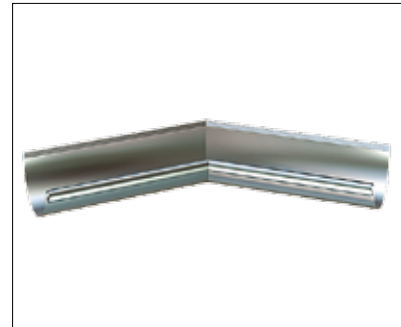
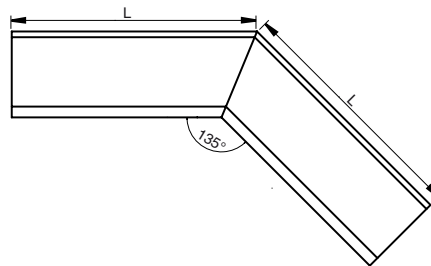

RVY135 Gutter angle 135°, outer

Dim	L mm
100	250
125	240
150	230

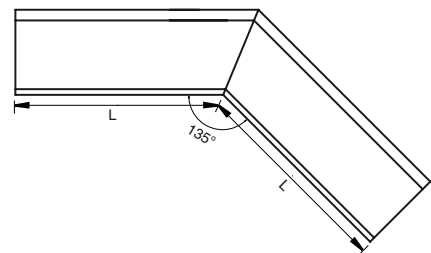

ÖSK Overflow protection

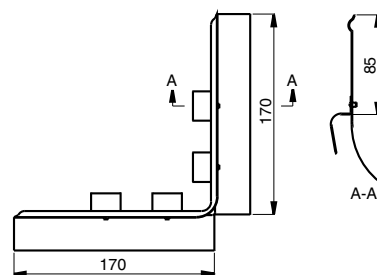

ÖSKR Overflow protection, straight

Dim
125
150

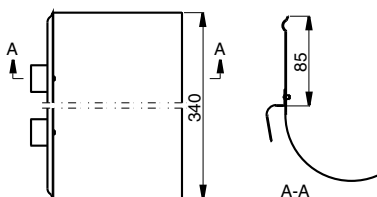

Technical Facts

Down Pipe with accessories

SRÖR Down pipe

Dim Di/d	Area mm ²
75	4400
87	5900
100	7800
111	9700
120	11300

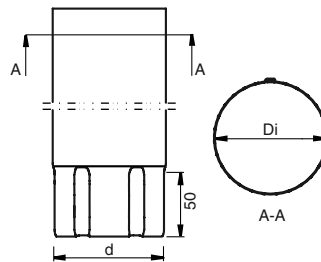

To SS-EN 612 Class A-X

BUTKF Reinforced drain shoe

Material:
Extruded aluminium.

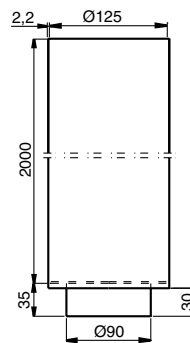

UTKF Reinforced shoe

Material:
Extruded aluminium.

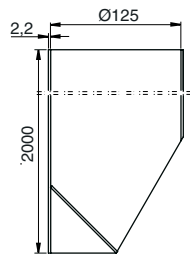

SVHÅF Reinforced pipe holder

The holder is reversible for different wall spacings.

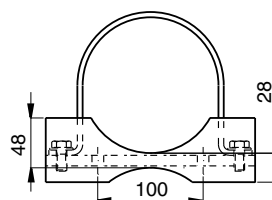

Technical Facts

Down Pipe with accessories

MST Intermediate pipe

Cuts into suitable pieces.

Dim
75
87
100
111
120

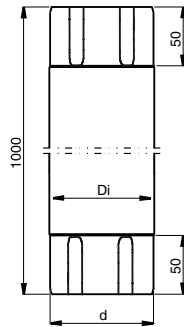

BK70 Bends 70°

Dim
Di/d
75
87
100
111
120

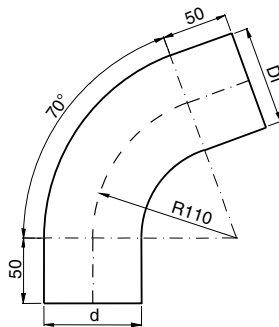

* Not BM. Will be replaced by 70 degrees bends, radius 110 mm.

BM70 Bends 70°

Dim
D/d
75
87
100
111
120

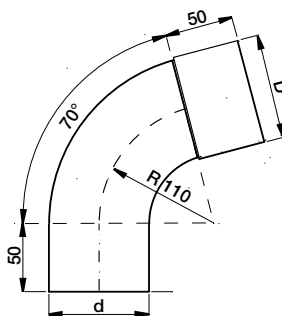

* Not BM. Will be replaced by 70 degrees bends, radius 110 mm.

SOKN One piece bend

Dim
D/d
75
87
100

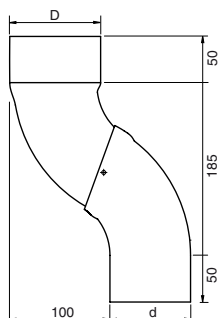

Technical Facts

Down Pipe with accessories

SRORM Pipe connector

Dim	
D/d	
	75
	87
	100

SRORM fits both inside and outside the downpipe.

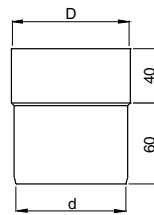

SSVH Pipe holder

Dim	
D	
	75
	87
	100
	111
	120

With wedge locking in aluminium-zinc design.

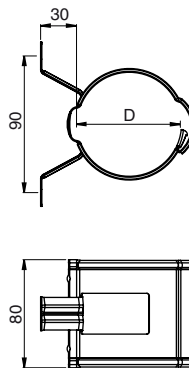

SSV Pipe holder for spike

Dim	
D	
	75
	87
	100
	111
	120

With wedge locking in aluminium-zinc design and fixed spine.

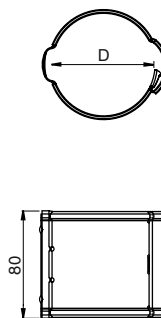

SST Spike

L	
mm	
	125
	175
	250
	300

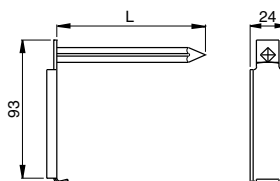

Technical Facts

Down Pipe with accessories

GRÖR Adjustable branch

Dim	
75	
87	
100	

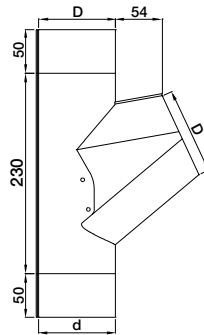

VATK Hopper

Dim	h
87	270
100	253
111	239
120	227

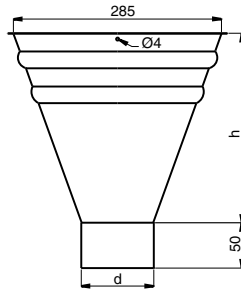

FRK Gutter hook

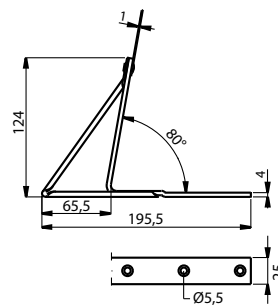

SLAS

Connector for 80 mm hose.
Dim
87

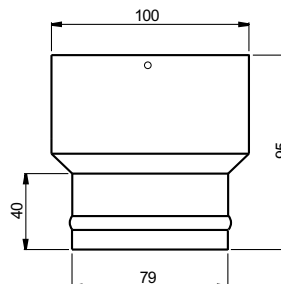

Technical Facts

Down Pipe with accessories

UTK Shoe

Dim	L mm
75	151
87	157
100	113
111	169
120	173

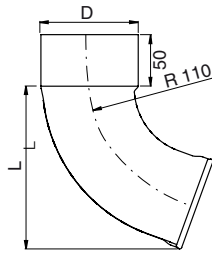

BUTK Drain shoe

Dim	D1 mm	D2 mm
75	81	115
87	93	115
100	93	115
111	93	119

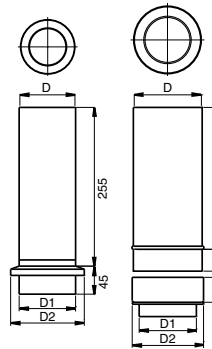

DVSIL Leaf filter

Stainless steel.

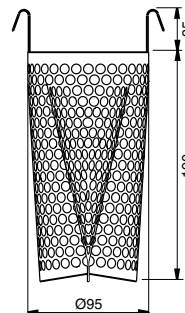

PRT Sliding pipe

Dim
75
87
100
111

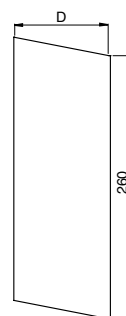

The sliding pipe fits outside the down pipe.

Technical Facts

Down Pipe with accessories

RT Drain trap (HD polythene)

Leaf filter in HD polythene for down pipes. The lower section fits standard ground pipes/junction pipes.

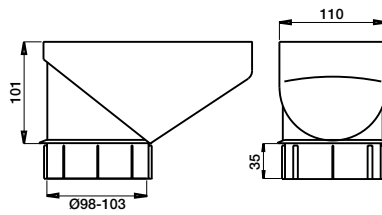

SLS Self cleaning leaf trap

Self cleaning leaf filter in HD polythene for down pipes. The lower section fits standard ground pipes.

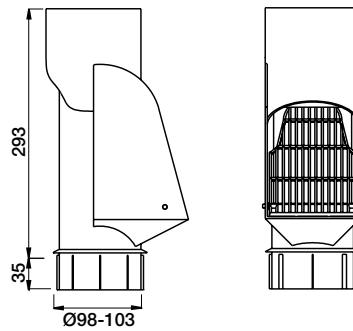

MRT Drain connector

Connector for HD polythene filters. For connection to ground pipes with dimensions other than standard.

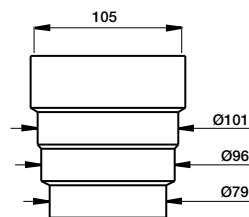

FUTK Adjustable shoe

Dim
75
87
100

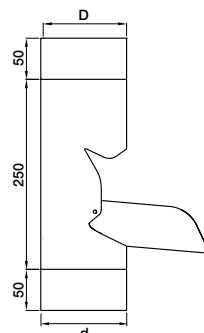

Technical Facts

Rectangular Gutter with accessories

RER Gutter

Dim	Area* mm ²
136	11000

* Water carrying area.

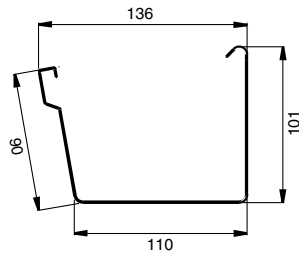

RERSK Gutter joint

Dim
136

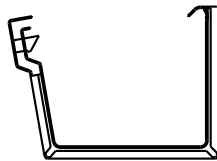

RERGH/RERGV Stop end

Dim
136

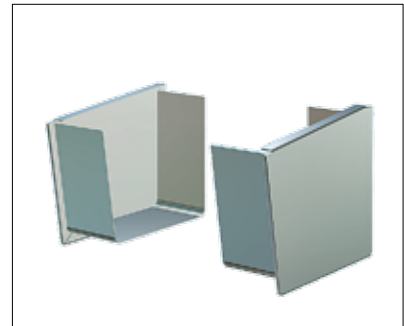
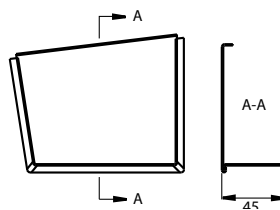

REK07/REK21 Bracket

Dim	L mm	
	REK07	REK21
136	70	210

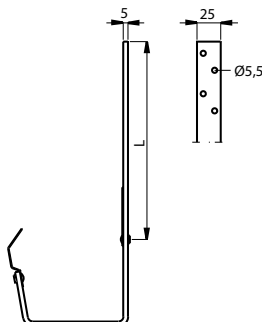

Technical Facts

Rectangular Gutter with accessories

REOK Nozzle

Dim	H
D/d	mm
136/87	95
136/100	85
136/111	75

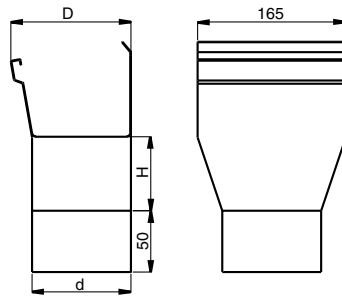

RERVI Gutter angle, inner

Dim	L mm
136	300

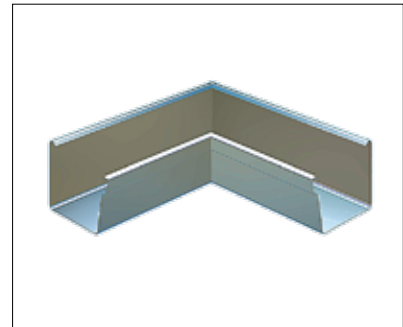
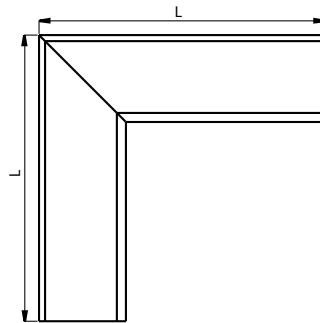

RERVY Gutter angle, outer

Dim	L mm
136	165

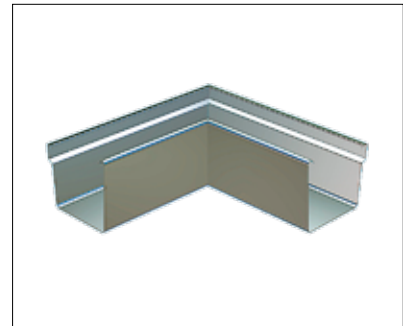
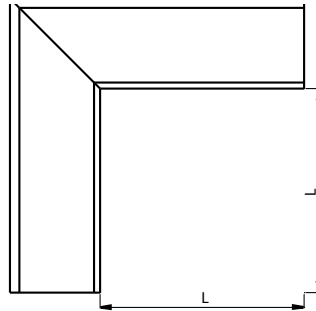

Technical Facts

Accessories

STIFT Touch up paint with applicator brush





Lindab Building Components is a business area within the Lindab Group that develops, manufactures and markets efficient, economical and aesthetic steel and sheet metal solutions for the building industry.

We offer a wide range of components and systems for all types of housing, as well as commercial and industrial buildings.

Lindab Building Components is represented in over 30 countries throughout Europe. Our head office is in Förslöv, in the south of Sweden.



Lindab Profile

SE-269 82 Båstad
Phone +46 (0)431 850 00
www.lindab.com